

# motion control

# SERVO MOTORS

Synchronous and Asynchronous  
Servo Motors for  
SIMOVERT MASTERDRIVES

**SIEMENS**

## Related Catalogs

**SIMOVER MASTERDRIVES Vector Control** DA 65.10  
0.55 kW (0.74 HP) to 2300 kW (3083 HP)  
Order No.:  
German: E86060-K5165-A101-A3  
English: E86060-K5165-A101-A3-7600



**SIMOVER MASTERDRIVES Motion Control** DA 65.11  
0.55 kW (0.75 HP) to 250 kW (335 HP)  
Order No.:  
German: E86060-K5165-A111-A3  
English: E86060-K5165-A111-A3-7600



**SIMODRIVE 611 universal and POSMO** DA 65.4  
Order No.:  
German: E86060-K5165-A401-A1  
English: E86060-K5165-A401-A1-7600



**Motion Control System SIMOTION** PM 10  
Order No.:  
German: E86060-K4910-A101-A4  
English: E86060-K4910-A101-A4-7600



**Components for Automation** CA 01  
Order No.:  
German: E86060-D4001-A100-C2  
English: E86060-D4001-A110-C2-7600



**A&D Mail**  
Internet:  
[www.siemens.com/automation/mall](http://www.siemens.com/automation/mall)



## CD-ROM for Catalog DA 65.3

The CD-ROM contains the following information:

- Information about planning and engineering based on the technical documentation; for additional technical documentation, visit: [www.siemens.com/automation/doconweb](http://www.siemens.com/automation/doconweb)
- Dimensional drawings of our motors are available to you in PDF or DXF format.
- Dimensional drawings of other products please find in the respective planning guides.  
Note: You can download dimensional drawings for the geared motors from the Internet at: [www.siemens.com/sgmdesigner](http://www.siemens.com/sgmdesigner)  
You can obtain the SGM Designer CD-ROM from your local Siemens office under order number **E86060-D5202-A100-A2**
- Catalog DA 65.3 in PDF format

### Hardware and Software Requirements

- Intel Pentium 333 MHz or higher
- At least 128 MB of RAM
- 1,024 x 768 pixel screen resolution
- Quadruple speed CD-ROM drive
- Windows 9x/NT 4.x/2000/XP
- Adobe Acrobat Reader
- MS Internet Explorer 5.5 or higher

### Startup

Insert the CD-ROM in your CD-ROM drive. The program will start up automatically. If the autorun function is not activated in your system, start the CD-ROM "start.hta" file in your Windows Explorer.

### Note

The information on this CD-ROM can be viewed without requiring any additional installations. The only exception is for the dimensional drawings, which are provided in DXF format.

### Hotline

E-mail your questions and comments to:  
[motioncontrol.docu@erlf.siemens.de](mailto:motioncontrol.docu@erlf.siemens.de)



## Trademarks

All product names mentioned may be trademarks or product designations of Siemens AG or their suppliers, whose use by third parties for their own purposes may infringe the rights of the trademark owners.

# Servo Motors

## Synchronous and Asynchronous Servo Motors

Catalog DA 65.3 · 2004

Supersedes:  
Catalog DA 65.3 · 2002 and  
Catalog MC Part 2 · 2002/2003  
(North American Catalog)

The products in this catalog  
are also included in the  
CA 01 CD-ROM catalog,  
Order No.:  
E86060-D4001-A110-C2-7600

Contact your local Siemens  
representative for more  
information.

© Siemens AG 2004



*The products and systems presented in this catalog are manufactured and distributed using a certified quality management system in accordance with DIN EN ISO 9001 (certificate registration number 001258 QM) and DIN EN ISO 14001 (certificate registration number 081342 UM). This certificate is recognized in all IQNet countries.*

  
**SIEMENS**

Overview

1

Synchronous Servo Motors

2

Asynchronous Servo Motors

3

Mounted Parts  
Geared Motors  
Gearboxes

4

Cables and Connections

5

Documentation

6

Configuration Notes

7

Appendix

A

# PATH Plus Configuration Notes

With the PATH Plus configuration program, you can quickly and easily configure frequency-converter-supplied drives in three-phase technology for the SIMOVERT MASTERDRIVES Vector Control and Motion Control device family.

PATH Plus is a powerful engineering tool that will assist you throughout all of the configuration steps, from configuring the incoming unit to the motor.

The system components and required motor are determined for a drives task through menu-based selection and layout of the frequency converters. Automatic display of configuration notes ensure error-free planning.

In addition, an extensive help system assists first-time users in operating the program. Using the mechanical requirements of the driven machine as a basis, PATH Plus guides the configuring engineer through a logical, user-friendly dialog procedure to a safe, reproducible, economical drives configuration. The technical data of the established frequency converters and motors, the selected system components, and the required accessories are listed in detail.

With PATH Plus, drives can be configured based on a load characteristic or load cycle, enabling configuration of applications such as:

- Running and hoisting gear
- Slewing gear
- Spindle drives
- Center winders
- Crank drives

PATH Plus includes a convenient graphical display of:

- Torque, rotational speed, power, current, velocity, and acceleration over time
- Torque over rotational speed.

System reactions are calculated and displayed graphically.

Configuration results can be stored on a data medium, printed out on paper, or copied by means of the clipboard to another user program for further editing.

PATH Plus is available with an English or German user interface.

The demo version of PATH Plus can be downloaded from the following Internet address:

<http://www.siemens.com/motioncontrol>

(Products & Solutions/Drive Technology/Engineering Software); alternatively, you can use the fax form in the appendix of this catalog.

You can obtain the full version of PATH Plus under order number: **6SW1710-0JA00-2FC0**

through your local Siemens office. Refer to the appendix of this catalog for the exact address.

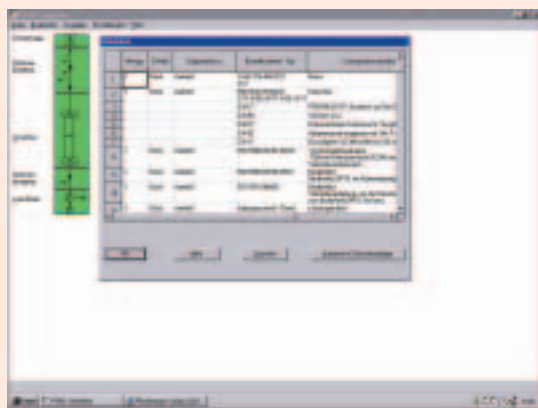
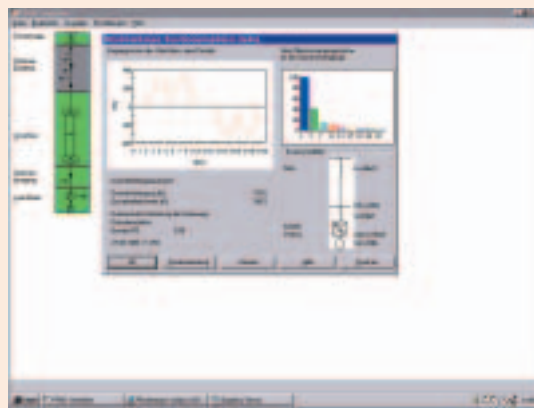
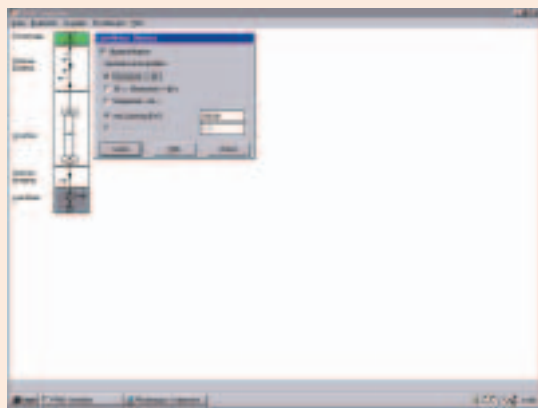

Order	Type	Component	Manufacturer	Part Number
1	Motor	1FK7083-9EX91-1AA0	Siemens	1FK7083-9EX91-1AA0
2	Frequency Converter	6ES7311-7CG03-0AB0	Siemens	6ES7311-7CG03-0AB0
3	Drive	6ES7311-7CG03-0AB0	Siemens	6ES7311-7CG03-0AB0
4	Power Supply	6ES7311-7CG03-0AB0	Siemens	6ES7311-7CG03-0AB0

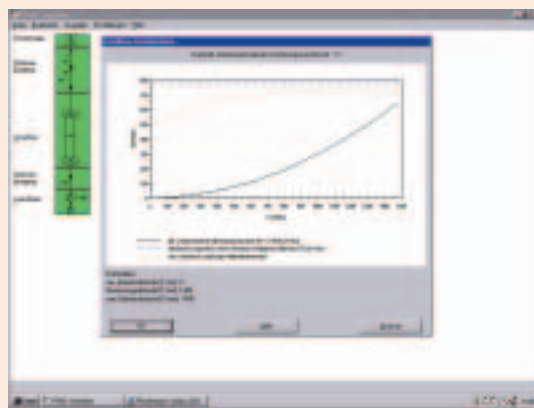

# Overview

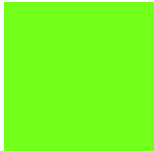

<b>1/2</b>	<b>Welcome to Automation and Drives</b>
<b>1/6</b>	<b>Brief Description</b>
<b>1/8</b>	<b>Flowchart for Selection Procedure</b>
<b>1/10</b>	<b>Type Overview and Ratings</b>
<b>1/12</b>	<b>Technical Definitions</b>



## Welcome to Automation and Drives

Welcome to Automation and Drives and our extensive range of products, systems, solutions, and services for production and process automation and building technology worldwide.

With Totally Integrated Automation and Totally Integrated Power, you get standards-based solution platforms with major cost-saving potential.

Come discover the world of Siemens technology. If you need more information, your local Siemens partner will be glad to assist you.





# Totally Integrated Automation – innovations for more productivity

With the launch of Totally Integrated Automation, we were the first ones on the market to consistently implement the trend from equipment to an integrated automation solution, and have continuously improved the system ever since. Whether your industry is process- and production-oriented or a hybrid, Totally Integrated Automation is a unique "common solution" platform that covers all the sectors. Totally Integrated Automation is an integrated platform for the entire production line - from receiving to technical processing

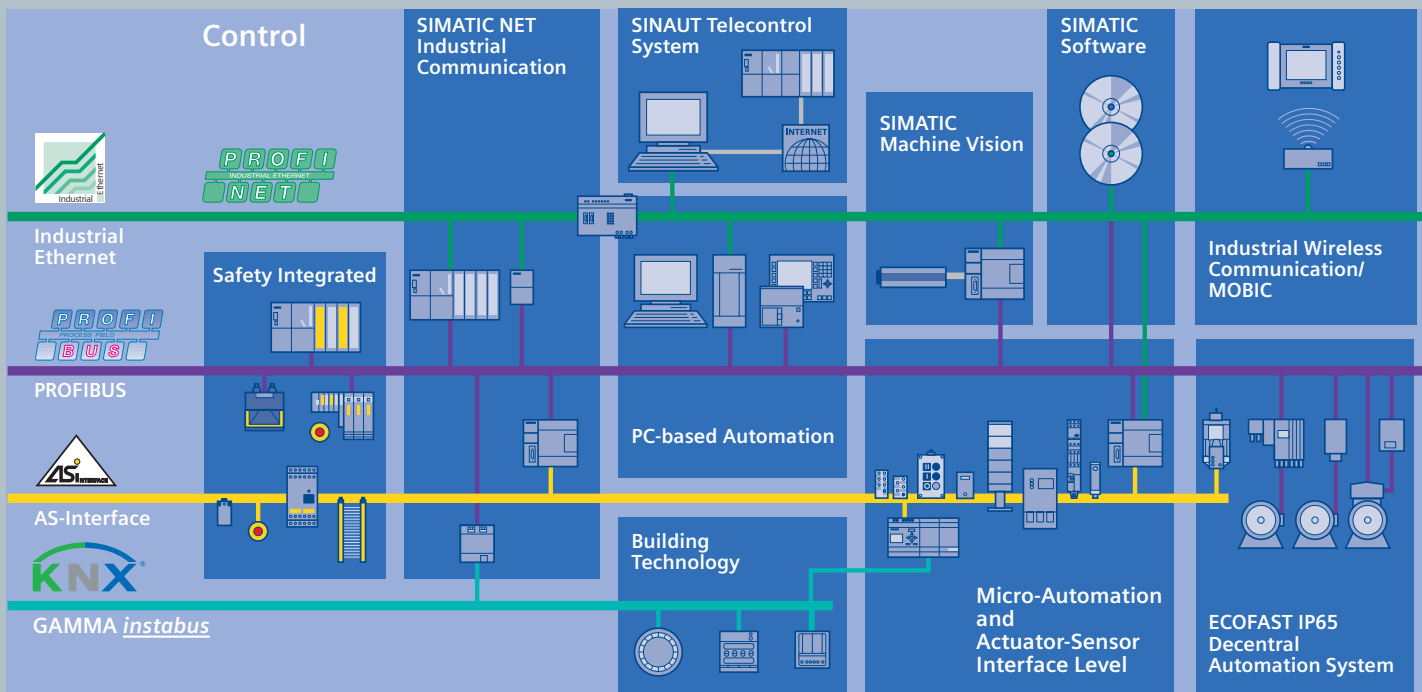
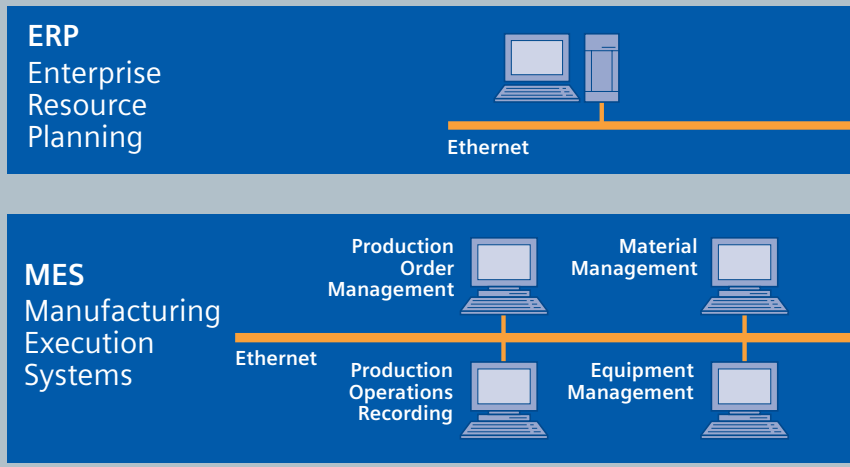



and production areas to shipping. Thanks to the system-oriented engineering environment, integrated, open communications as well as intelligent diagnostics options, your plant now benefits in every phase of the life cycle. In fact, to this day we are the only company worldwide that can offer a control system based on an integrated platform for both the production and process industry.

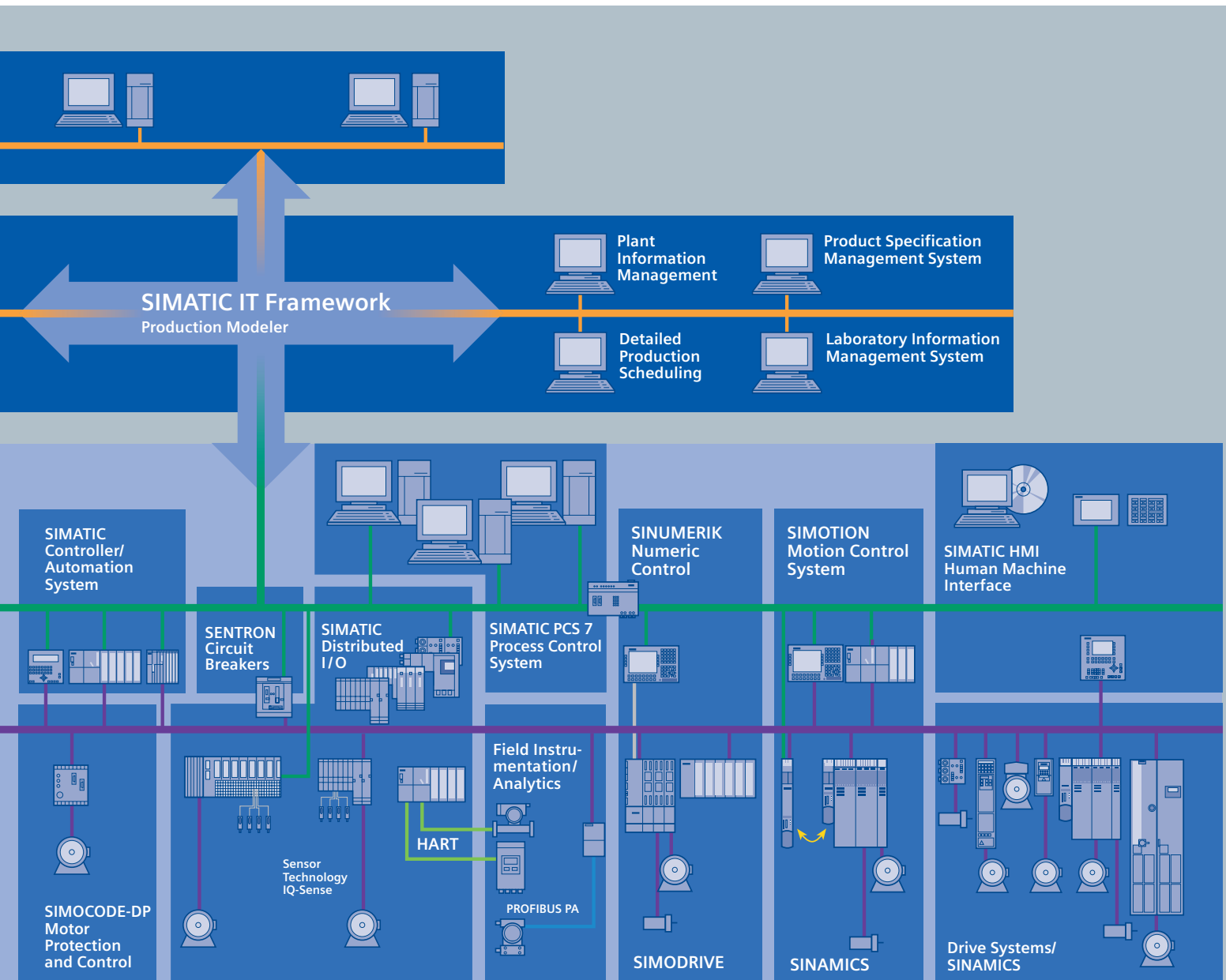

# Servo Motors

## Overview

### Brief Description

SIEMENS servo motors were designed especially for the stringent requirements that must be met by variable-speed drives.

#### Models

- Synchronous servo motors
- Asynchronous servo motors

#### Main features

- Compact design
- High power density and overload capacity
- High maximum rotational speed
- Integrated encoder system
- High dynamic response due to low rotor inertia torque
- Excellent smooth running characteristics
- Robust, virtually maintenance-free construction

#### Synchronous servo motors

Special features of synchronous servo motors include:

- High overload capacity
- High dynamic response
- High static torque.

#### 1FK7 Servo Motors

1FK7 servo motors cover the lower power range 0.4 kW (0.5 HP) to 8.2 kW (11 HP), and their optimized design makes them the most economical solution for many applications.

Special features of 1FK7 servo motors include:

- Extremely high dynamic response (1FK7 HD, High Dynamic),
- Compact design (1FK7 CT, Compact)
- Expanded power range and options.

The new 1FK7 servo gear motors with directly built-on spur gearing, flat gearing, bevel gearing, and worm gearing are supplied as a complete unit.

#### 1FT6 Servo Motors – High Performance

- 1FT6 servo motors can be implemented for extremely stringent requirements in a power range of 0.2 kW (0.3 HP) to 118 kW (158 HP).

These motors are available as externally ventilated, water-cooled, or natural cooled motors with IP64 to IP68 degree of protection. Their many options make them the optimal solution for many high-end applications.

#### 1FS6 Servo Motors – Explosion-Protected Design

1FS6 servo motors are designed for use in Zone 1 hazardous areas. These motors comply with EEx de IIC T3 type of protection.

#### 1FW3 Torque Motors

With their high torque at low rotational speeds, the 1FW3 complete torque motors are designed to be direct drives. Due to an integrated water-cooling system, these motors have a very compact design.

#### 1PH7, 1PL6, 1PH4 asynchronous servo motors

These compact asynchronous motors supplement the synchronous servo motors for applications in the upper power range up to 630 kW (845 HP).

Models:

- 1PH7 externally ventilated motors with IP55 degree of protection
- 1PH4 water-cooled motors with IP65 degree of protection
- Externally ventilated and enclosed-ventilated 1PL6 motors with IP23 degree of protection.

These motors permit the full rated torque in the entire constant flux range.

They are equipped with the relevant options according to the requirements:

- Encoders (HTL incremental encoders, resolvers, 1 V<sub>pp</sub>, or absolute value encoders)
  - Holding brake
- Planetary gearing can be built onto all servo motors as required.

Optionally, these motors can be harmonized with SIMOVERT® MASTERDRIVES converters to create high-performance drives systems (see also catalogs DA 65.10 and DA 65.11).

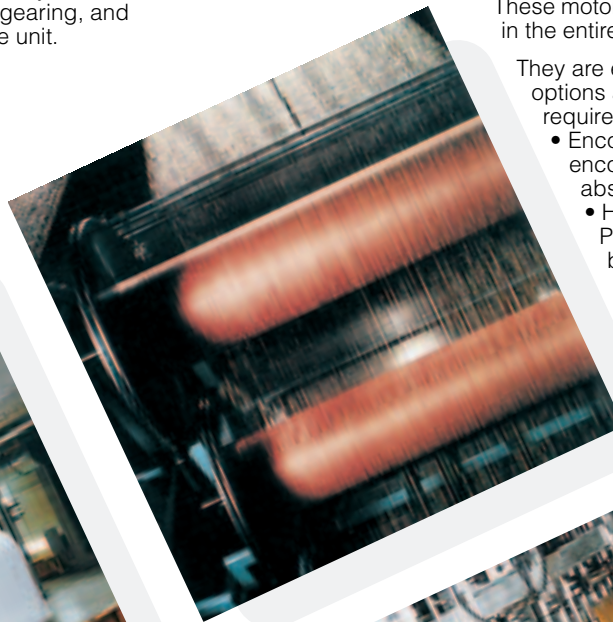



## Optimal Integration of Motors in the Automation Landscape

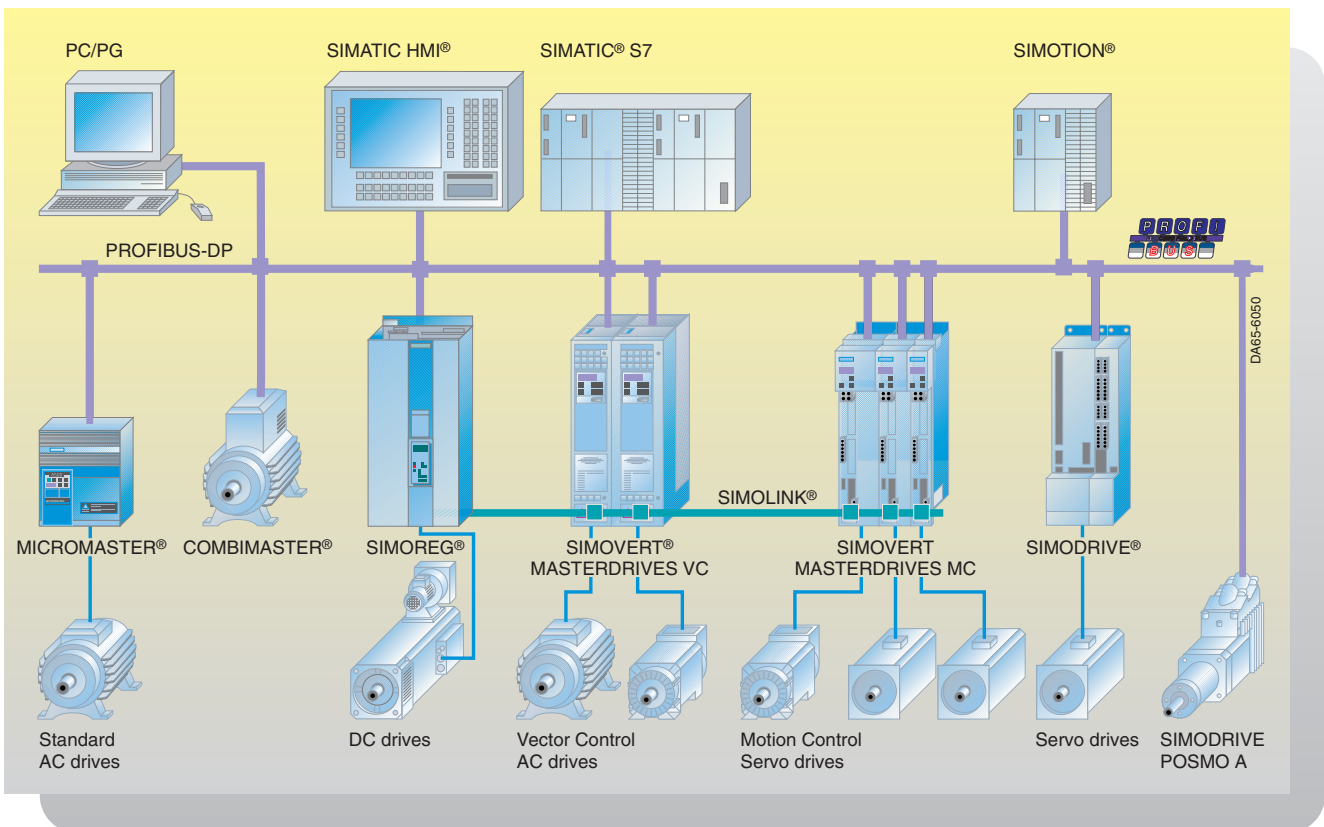

# Servo Motors

## Overview

### Flowchart for Selection Procedure

#### Basic information

In order to select the correct drive and motor, the specific speed and load cycle of the drive application must be known.

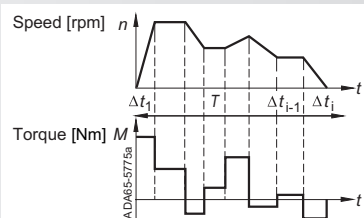

#### Step 1

#### Specifying the degree of protection:

IP23; IP55; IP64; IP65; IP67; IP68

For details, see Part 1

#### Step 2

#### Specifying the supply voltage:

380 to 400 V; 460 to 480 V

#### Step 3

#### Specifying the type of construction:

IM B3 (foot-mounting); IM B5 (flange-mounting); IM B35 (foot/flange-mounting)

For details, see Part 7

#### Step 4

#### Specifying the maximum torque from the load-cycle profile

#### Step 5

#### Specifying the average (rms) torque

#### Step 6

#### Specifying the motor type needed (synchronous/asynchronous servomotor):

1FK7; 1FT6; 1FS6; 1FW3; 1PH7; 1PL6; 1PH4

See Overview in Part 1

#### Step 7

## Flowchart for Selection Procedure

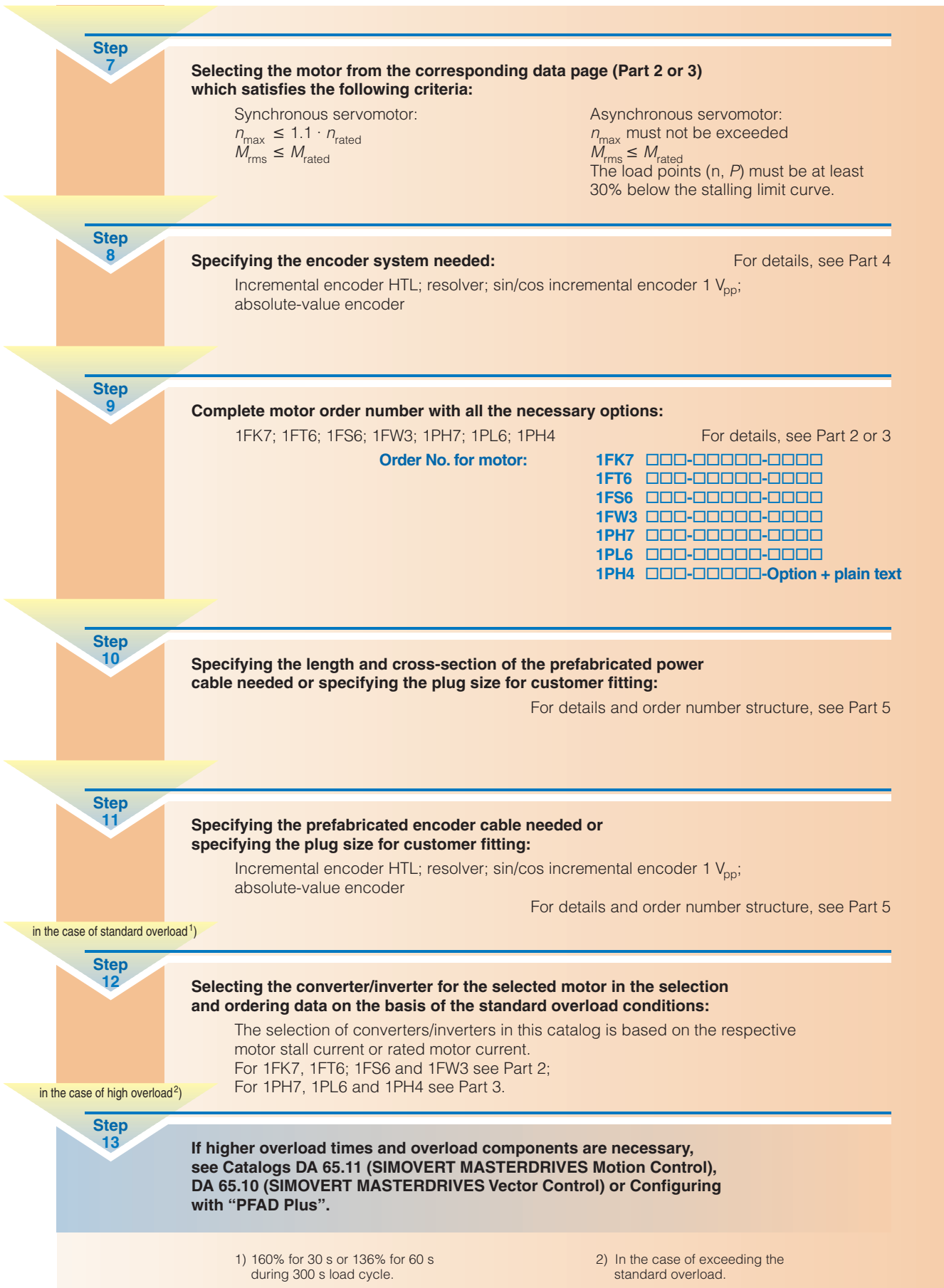

1) 160% for 30 s or 136% for 60 s during 300 s load cycle.

2) In the case of exceeding the standard overload.























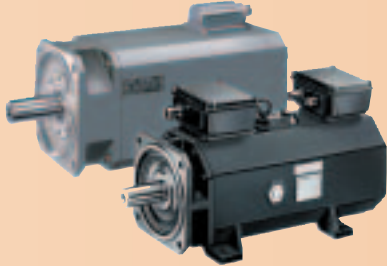

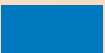
# Servomotors

## Overview

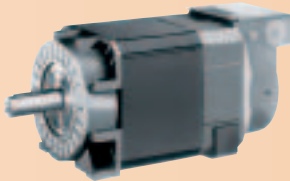
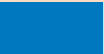
### Overview of types and rated data

Motor types	Designation/Method of functioning	Degree of protection	Cooling	Shaft height
<b>1FK7 CT</b> (Compact)	Compact servomotor Frameless permanent-magnet synchronous motor	IP64 (IP65 optional)	Natural cooling	28 to 100
<b>1FK7 HD</b> (High Dynamic)	High Dynamic servomotor with extremely low rotor moment of inertia		Natural cooling	36 to 80
<b>1FT6</b>	Servomotor – High Performance Permanent-magnet synchronous motor	IP64 (IP65, IP67, IP68 optional)	Natural cooling Forced ventilation Water cooling	28 to 132 80 to 160 63 to 160
<b>1FS6</b> 	Servomotor – explosion-proof Permanent-magnet synchronous motor with EEx de II C T3 explosion protection	IP64 (IP65 optional)	Natural cooling	71 to 132
<b>1FW3</b>	Torque motor Liquid-cooled permanent-magnet synchronous motor	IP54	Water cooling	200 280
<b>1PH7</b>	Asynchronous servomotor Frameless three-phase squirrel-cage motor	IP55	Forced ventilation Surface cooling	100 to 280
<b>1PL6</b>	Asynchronous servomotor Frameless three-phase squirrel-cage motor	IP23	Forced ventilation Axial ventilation	180 to 280
<b>1PH4</b>	Asynchronous servomotor Liquid-cooled three-phase squirrel-cage motor	IP65	Water cooling	100 to 160

## Overview of types and rated data

Power range	Rated torque	Selection and ordering data on pages	
<b>0.4 kW</b>  <b>8.2 kW</b> <b>0.5 HP</b>  <b>11 HP</b>	0.6 to 37 Nm 5.3 to 327 lb <sub>f</sub> -in	2/4	
<b>0.6 kW</b>  <b>3.1 kW</b> <b>0.8 HP</b>  <b>4.2 HP</b>	0.9 to 12 Nm 8 to 106 lb <sub>f</sub> -in	2/6	
<b>0.2 kW</b>  <b>15.5 kW</b> <b>0.25 HP</b>  <b>20.7 HP</b> <b>6.9 kW</b>  <b>89 kW</b> <b>9.2 HP</b>  <b>119 HP</b> <b>3.2 kW</b>  <b>118 kW</b> <b>4.3 HP</b>  <b>158 HP</b>	0.3 to 88 Nm 2.7 to 780 lb <sub>f</sub> -in 17 to 540 Nm 150 to 4780 lb <sub>f</sub> -in 10 to 690 Nm 89 to 6107 lb <sub>f</sub> -in	2/10 to 2/21 2/22 to 2/31 2/28 to 2/33	
<b>1.2 kW</b>  <b>12.4 kW</b> <b>1.6 HP</b>  <b>16.6 HP</b>	1.9 to 68 Nm 16.8 to 602 lb <sub>f</sub> -in	2/36 and 2/37	
<b>8.0 kW</b>  <b>146 kW</b> <b>10.7 HP</b>  <b>195.7 HP</b>	300 to 7000 Nm 221 to 5163 lb <sub>f</sub> -ft	2/40 and 2/41	
<b>3.7 kW</b>  <b>385 kW</b> <b>5 HP</b>  <b>516 HP</b>	22 to 2480 Nm 16 to 1829 lb <sub>f</sub> -ft	3/4 to 3/41	
<b>20.5 kW</b>  <b>630 kW</b> <b>27.5 HP</b>  <b>844 HP</b>	370 to 3600 Nm 273 to 2655 lb <sub>f</sub> -ft	3/46 to 3/67	
<b>7.5 kW</b>  <b>65 kW</b> <b>10 HP</b>  <b>87 HP</b>	45 to 333 Nm 35 to 246 lb <sub>f</sub> -ft	3/72 to 3/75	

#### Regulations, Standards and Specifications

These motors comply with the relevant standards and regulations; see table below.

Many countries have completely harmonized their national regulations with the international IEC 60034-1 recommendation; as a result, the coolant temperatures, temperature classes, and temperature-rise limits in these national regulations are now the same as in IEC 60034-1.

The following motors have the UL approval of "Underwriters Laboratories Inc.®" as well as approval for Canadian standards indicated by the URc symbol 1FK7, 1FT6 natural cooled, 1FW3, 1PH7 (without brake), 1PL6, 1PH4.

Title	DIN/VDE	EN	IEC
General Specifications for Rotating Electrical Machines	DIN VDE 0530 Part 1	EN 60034-1	IEC 60034-1
Terminal Markings and Direction of Rotation for Electrical Machines	DIN VDE 0530 Part 8	EN 60034-8	IEC 60034-8
Types of Construction of Rotating Electrical Machines	DIN VDE 0530 Part 7	EN 60034-7	IEC 60034-7
Methods of Cooling for Rotating Electrical Machines	DIN VDE 0530 Part 6	EN 60034-6	IEC 60034-6
Degrees of Protection of Rotating Electrical Machines	DIN VDE 0530 Part 5	EN 60034-5	IEC 60034-5
Vibration Severity of Rotating Electrical Machines	DIN VDE 0530 Part 14	EN 60034-14	IEC 60034-14
Noise Limits of Rotating Electrical Machines	DIN VDE 0530 Part 9	EN 60034-9	IEC 60034-9
Cylindrical Shaft Ends for Electrical Machines	DIN 748 Part 3	–	IEC 60072

#### Most Common Degrees of Protection for AC Motors in Accordance with IEC 60034-5

Taking into account the operating and environmental conditions, an appropriate degree of protection is selected to prevent the following occurrences:

- Ingress of water, dust and foreign objects
- Contact with the rotating parts inside a motor
- Contact with energized parts

The degrees of protection for electrical machines are indicated by a code composed of two letters, two numbers, and an additional letter, if required.

#### IP (International Protection)

These letters stand for the degree of protection against contact and ingress of foreign objects and water

#### 0 to 6

The first number stands for the degree of protection against contact and ingress of foreign objects

#### 0 to 8

The second number stands for the degree of protection against ingress of water (not including oil insulation)

#### W, S and M

Additional letters stand for special types of protection

Primarily, these motors are supplied with the following degrees of protection:

Motor	Degree of Protection	1st Number Protection against Contact	Protection against Foreign Objects	2nd Number Water Protection
Internally cooled	<b>IP23</b>	Protected against finger contact	Protected against medium-sized foreign objects greater than 12 mm (0.47 in) Ø	Protected against spraying water when tilted up to 60 °C (140 °F)
Surface cooled	<b>IP54</b>	Fully protected against contact	Protected against harmful dust deposits	Splashing water from all directions
	<b>IP55</b>			Water jets from all directions
	<b>IP64</b>	Fully protected against contact	Protected against dust penetration	Splashing water from all directions
	<b>IP65</b> <sup>1)</sup>			Water jets from all directions
	<b>IP67</b> <sup>1)</sup>			Motor is protected against effects of immersion for specific time and pressure
	<b>IP68</b> <sup>1)</sup>			Motor is suited for continuous submersion under conditions described by the manufacturer

1) In accordance with DIN VDE 0530 Part 5 and EN 60034 Part 5, for rotating electrical machines, there are only five degrees of protection for the first number and eight degrees of protection for the second number. However, IP6 is contained within DIN 40 050, which applies for electrical equipment in general.

## Radial Eccentricity Tolerance, Shaft and Flange Accuracy (Concentricity and Axial Eccentricity) in Accordance with IEC 60072

**Radial eccentricity tolerance of the shaft to the housing axis** (with reference to the cylindrical shaft ends)

Shaft height	Standard N		Option R	
	mm	(in)	mm	(in)
28, 36	0.035	(0.0014)	0.018	(0.0007)
48, 63, 71	0.04	(0.0016)	0.021	(0.0008)
80, 100, 132	0.05	(0.002)	0.025	(0.001)
160, 180, 225	0.06	(0.0023)	0.03	(0.0012)
280	0.07	(0.0028)	0.035	(0.0014)

**Concentricity and axial eccentricity tolerance of the flange surface to the shaft axis** (with reference to the centering diameter of the mounting flange)

Shaft height	Standard N		Option R	
	mm	(in)	mm	(in)
28, 36, 48	0.08	(0.0031)	0.04	(0.0016)
63, 71, 80, 100	0.1	(0.004)	0.05	(0.002)
132, 160, 180, 225	0.125	(0.0049)	0.063	(0.0025)
280	0.16	(0.0063)	0.08	(0.0031)

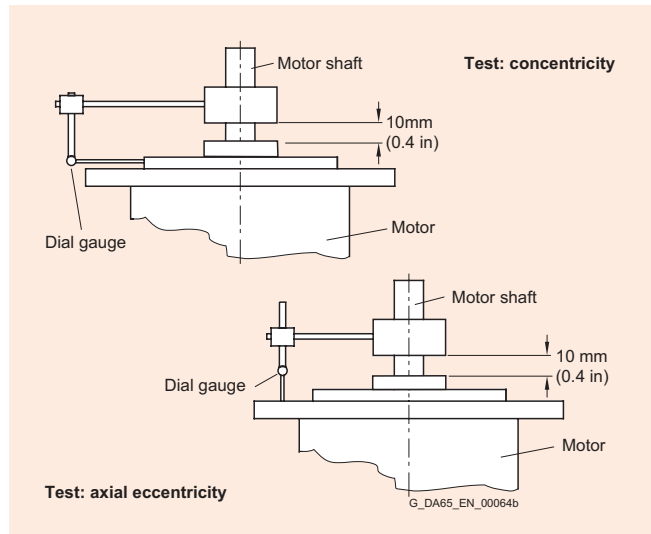
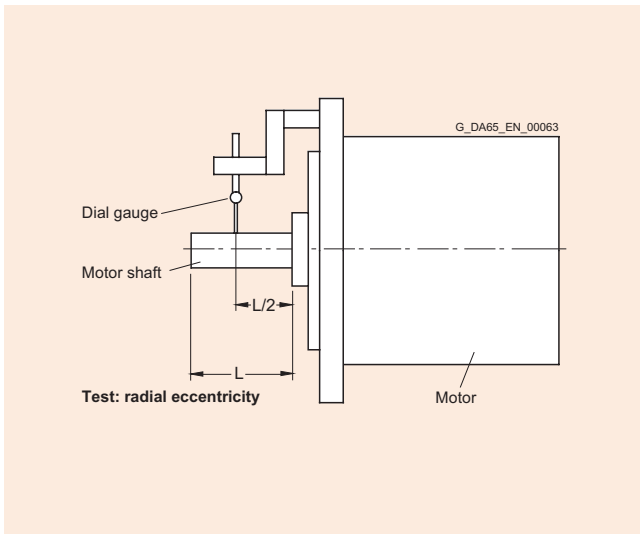

## Vibration Severity Levels in Accordance with IEC 60034-14

The vibration severity is the quadratic mean (rms) value of the vibration velocity (in a frequency range of 10 to 1000 Hz). The vibration velocity is measured with electrical measuring equipment in accordance with DIN 45 666.

The values indicated refer only to the motor. The system vibration characteristics due to installation can cause these values to increase.

Rotational speeds of 1800 rpm and 3600 rpm and their associated limits are specified in accordance with IEC 60034-14. Rotational speeds of 4500 rpm and 6000 rpm and their associated values have been specified by the motor manufacturer.

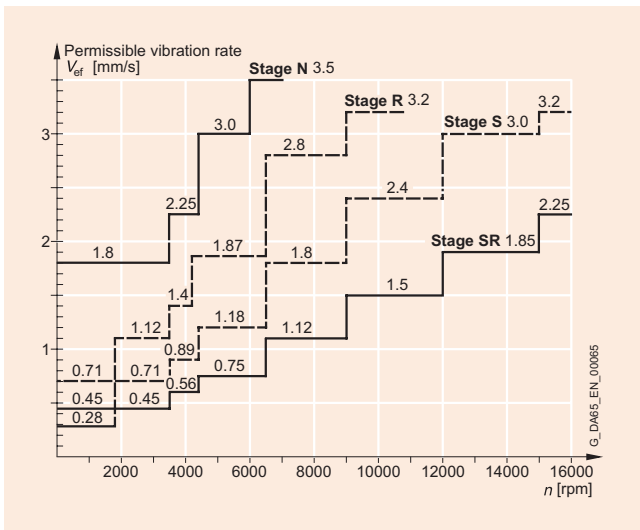

Vibration Severity Level Limits for Shaft Heights of 28 to 132

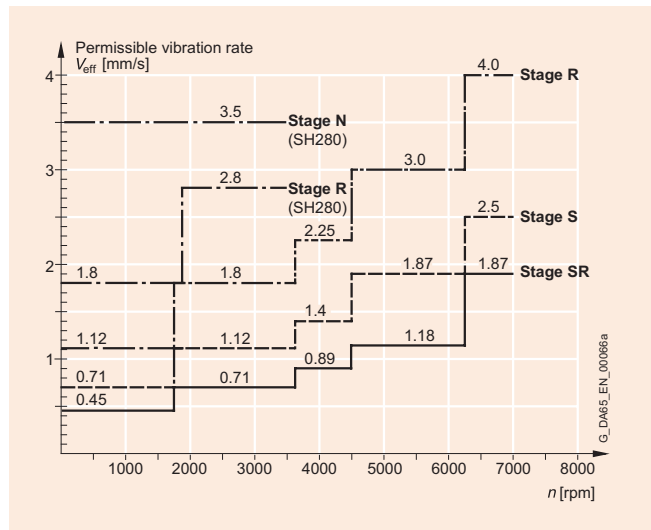

Vibration Severity Level Limits for Shaft Heights of 160 to 280

# Servo Motors

## Overview

### Technical Definitions

#### Balancing in Accordance with DIN ISO 8821

##### Requirements for the balancing process for attachment parts, belt pulleys, in particular

The vibrational quality characteristics of motors with attached belt pulleys are determined primarily by the balance of the attachment part, as well as the balance quality of the motor.

If the motor and the attachment part are balanced separately prior to assembly, the balancing process of the belt pulley must be adapted to the balancing type of the motor. The following balancing types exist for motors 1PH4, 1PH7, and 1PL6:

- Half-key balancing
- Full-key balancing
- Keyless shaft end

For motors 1PH7 and 1PL6, the balancing type is coded in the order designation. Half- and full-key balanced motors are identified by an "H" (half-key) or an "F" (full key) on the shaft end face.

Motors 1FK7 and 1FT6 with featherkey are always half-key balanced.

In general motors with a keyless shaft are recommended for systems with the most stringent vibrational quality requirements. Belt pulleys with two opposite featherkey ways, but only one featherkey in the shaft end, are recommended for full-key-balanced motors.

#### Vibration Stress, Immitted Vibration Values

The following maximum permissible vibration stress limits at full reliability performance apply only for the permanent-magnet synchronous motors 1FK7, 1FT6, and 1FS6 with applied brake.

Vibration stress (in accordance with IEC 68-2-6):

- 1 g axial (20 Hz to 2 kHz)
- 5 g radial (20 Hz to 2 kHz).

For all asynchronous motors 1PH7, 1PH4, and 1PL6, the following limits apply for (immitted) vibration values introduced externally to the motor.

Vibration frequency	Vibration Values for	Shaft Heights	
		100 to 160	180 to 280
<6.3 Hz	Vibration displacement $s$	$\leq 0.16$ mm (0.007 in)	$\leq 0.25$ mm (0.010 in)
6.3 ... 63 Hz	Vibration velocity $V_{rms}$	$\leq 4.5$ mm/s (0.18 in/s)	$\leq 7.1$ mm/s (0.28 in/s)
>63 Hz	Vibration acceleration $a$	$\leq 2.55$ m/s <sup>2</sup> (8.38 ft/s <sup>2</sup> )	$\leq 4.0$ m/s <sup>2</sup> (13.13 ft/s <sup>2</sup> )

#### Coolant (Air) Temperature and Installation Altitude

Operation (unrestricted) CT =  $-15^{\circ}\text{C}$  ( $+5^{\circ}\text{F}$ ) to  $+40^{\circ}\text{C}$  ( $104^{\circ}\text{F}$ )

The rated output (rated torque) is applicable for continuous duty (S1) operation in accordance with DIN EN 60034-1 at the rated frequency, a coolant temperature (CT) of  $40^{\circ}\text{C}$  ( $104^{\circ}\text{F}$ ), and an installation altitude of 1000 m (3281.5 ft) above sea level.

All motors are Thermal Class F motors and are utilized in accordance with Thermal Class F. For all other conditions, the table on the right must be used to determine the permissible output (torque).

The coolant temperature and installation altitude are rounded to  $5^{\circ}\text{C}$  ( $41^{\circ}\text{F}$ ) and 500 m (1640.8 ft), respectively.

Note about surface temperature:

The surface of these motors can reach a temperatures of over  $100^{\circ}\text{C}$  ( $212^{\circ}\text{F}$ ).

Installation Altitude above Sea Level	Coolant Temperature CT in $^{\circ}\text{C}$ ( $^{\circ}\text{F}$ )			
	<30 (86)	30–40 (86–104)	45 (113)	50 (122)
m (ft)				
1000 (3281.5)	1.07	1.00	0.96	0.92
1500 (4922.3)	1.04	0.97	0.93	0.89
2000 (6563)	1.00	0.94	0.90	0.86
2500 (8203.7)	0.96	0.90	0.86	0.83
3000 (9844.5)	0.92	0.86	0.82	0.79
3500 (11485.3)	0.88	0.82	0.79	0.75
4000 (13126)	0.82	0.77	0.74	0.71



## Operating Modes S1 and S6 in Accordance with EN 0530

### S1: Continuous Running Duty

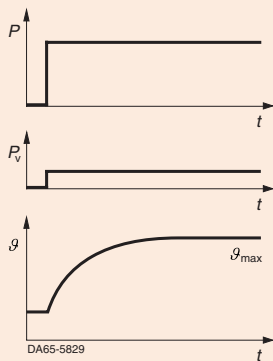

Duty cycle under constant load condition of sufficient duration to establish thermal equilibrium

Designation: S1

Output specification (torque)

### S6: Continuous Operation Periodic Duty

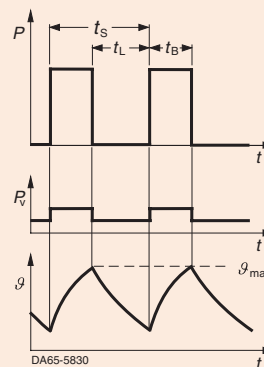

Duty cycle comprising a sequence of identical duty cycles, each of which consists of a period of constant load followed by an interval at no load. There are no de-energized intervals.

Designation:

i.e.: S6 - 40 %, 85 kW (114 HP).

$$t_r = \frac{t_B}{t_B + t_L}, t_s = 10 \text{ min}$$

## Nameplates

SIEMENS			
3 ~ Motor 1FK7060-5AF71-1EH0			
No. YF PN18 4583 01 001			
$M_o$ 6,0 Nm	$I_o$ 4,5 A	$n_N$ 3000 /min.	
$M_n$ 4,7 Nm	$I_n$ 3,7 A	$n_{max}$ 6600 /min.	
Th.Cl.F	$U_{in}$ 253 V	IP 64	
Encoder F02 Brake EBD 0,8B / 24 V -- / 15 W			
Rev. No. 000			
c RU		CE EN60034	
Made in Germany			

Example from the 1FK7 Series, Shaft Height 28 to 100 (Adhesive Plate)

SIEMENS			3 ~ Brushless Servomotor	RU c RU CE
1FT6084-1AF71-3EG1			No. YF P118 9979 01 001 EN 60034	
Made in Germany				
$M_0 = 16,6/20,0$ Nm	$I_0 = 11,3/14,0$ A	60/100K		
$M_N = 14,0$ Nm	$n_N = 3000$ /min	$U_{IN} = 270$ VY		
IMB5	IP 65	Th.CL.F	$n_{max} = 4700$ /min	
ABSOLUTE-ENCODER F02 2048 S/R KTY 84				

Example from the 1FT6 Series (Metal Plate)

SIEMENS		c RU RU CE		CE	
3 ~ Mot. 1PH7137 - 2NG00 - 0BA0 Nr.YF L994 0025 01 001					
IM B3		IP 55/54		Th.Cl.F	
V	A	kW	cos φ	Hz	1/min
350 Y	60,00	28,00	0,88	68,0	2000 S1
398 Y	56,00	29,00	0,87	77,8	2300 S1
450 Y	52,00	30,00	0,84	89,4	2650 S1
EN 60034					max. 8000 /min
TEMP - SENSOR KTY 84 - 130 ENCODER D01 2048 S/R					
CODE-NR.: 412					
Made in Germany					

Example from the 1PH7 Series, Shaft Height 100 to 160 (Adhesive Plate)

SIEMENS c RU RU CE						
3 ~ Mot. 1PL6228-4HF00-0AA0 No N- 1102033010001 / 2000						
IM B3		IP 23		Th.Cl. F		Gew./WT 870 kg
V	A	kW	cos φ	Hz	1/min	
345 Y	476	230	0.86	51	1500	
400 Y	473	265	0.86	59	1750	
460 Y	452	288	0.85	67	2000	
EN60034-1 IEC 34-1					max	4500 1/min
KTY84						
ENCODER H01 1024 S/R						
MADE IN GERMANY						

Example from the 1PL6 Series, Shaft Height 180 to 280 (Metal Plate)

# Servo Motors

## Overview

### Technical Definitions

#### Rated Torque

The torque supplied on the shaft is indicated in Nm (lb<sub>f</sub>-in or lb<sub>f</sub>-ft) in the technical selection table.

$$M_{\text{rated}} = P_{\text{rated}} \cdot \frac{9550}{n_{\text{rated}}}$$

$P_{\text{rated}}$  Rated output in kW  
 $n_{\text{rated}}$  Rated speed in rpm  
 $M_{\text{rated}}$  Rated torque in Nm

$$M_{\text{rated}} = P_{\text{rated}} \cdot \frac{5250}{n_{\text{rated}}}$$

$P_{\text{rated}}$  Rated output in HP  
 $n_{\text{rated}}$  Rated speed in rpm  
 $M_{\text{rated}}$  Rated torque in lb<sub>f</sub>-ft

#### DURIGNIT IR2000 Insulation

The DURIGNIT® IR 2000 insulation system consists of high-quality enameled wires and insulating sheeting in conjunction with solvent-free resin impregnation.

It ensures that these motors will have a high level of mechanical and electric strength as well as a high service value and a long service life.

This insulation protects the winding to a large degree from the influence of harmful gases, fumes, dust, oil, and high humidity and withstands normal vibration stresses.

The motor insulation is tropicalized, i. e., suitable for air humidity levels of up to 100 %.

All motors have Thermal Class F insulation.

The utilization of these motors corresponds to a Thermal Class F rated output/torque.

#### Motor Protection

The KTY 84-130 temperature sensor is used to measure the motor temperature for motor operation on the converter.

This sensor is a semiconductor that changes resistance according to a defined curve in relationship to the temperature.

Siemens converters measure the motor temperature by means of the temperature sensor resistance.

Their parameters can be set for specific warning and shutdown temperatures.

The KTY 84-130 temperature sensor is built into the winding overhang of the motor like a PTC thermistor.

The standard converter for this analysis is the SIMOVERT MASTERDRIVES.

If the motors are operated on converters that do not have KTY 84 analysis, the temperature can be measured with the 3RS10 temperature monitoring relay. For detailed information, see Catalog LV 10.

Example units:

- Control supply voltage: 24 V AC/DC  
Order no. 3RS1040-1GD50
- Control supply voltage: 24–240 V AC/DC  
Order no. 3RS1040-1GW50

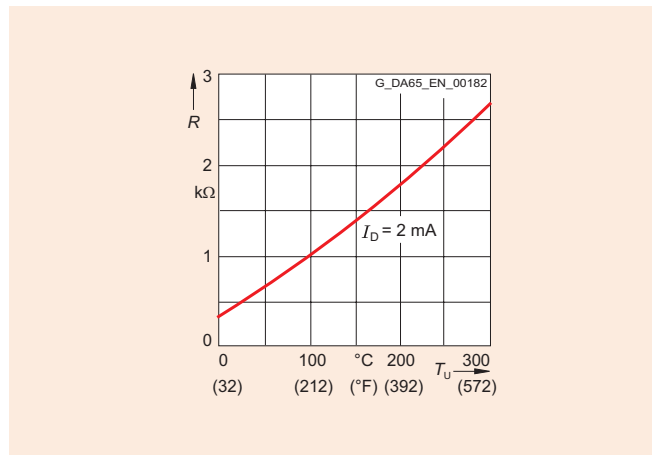

#### Paint Finish

The following finishes are available for these motors:

- Unpainted (coated with impregnating resin) e.g. 1FK7 or 1PH7 (shaft height up to 160)
- Primed (for corrosion control) e.g. 1PH7, 1PL6 (shaft height 180 and higher)

- Standard finish (e.g. RAL 7016) e.g. 1PH4, 1PH7, 1PL6, 1FK7, 1FS6
- Special finish (e.g. RAL 7016) e.g. 1FT6, 1PH7, 1PL6

All motors can be painted over with commercially available paint (up to 2 additional coats).

Type	Paint finish Suitability for Climate Group in Accordance with DIN IEC 60721, Part 2–1	Short-term:	Permanent:
Standard finish	<b>Moderate</b> (expanded) For indoor and outdoor installation	Up to 120 °C (248 °F)	Up to 100 °C (212 °F)
Special finish	<b>Worldwide</b> (expanded) For outdoor installation	Up to 140 °C (284 °F)	Up to 120 °C (248 °F)
		Also:	Corrosive atmospheres of up to 1% acid or base concentration or in sheltered, permanently damp areas

## Synchronous Servo Motors



<b>2/2</b>	<b>1FK7 Motors</b>
<b>2/8</b>	<b>1FT6 Motors</b>
<b>2/34</b>	<b>1FS6 Motors</b>
<b>2/38</b>	<b>1FW3 Torque Motors</b>



# Servo Motors for SIMOVERT MASTERDRIVES

## Synchronous Servo Motors

### 1FK7 Motors Natural cooling

#### Overview



1FK7 Synchronous Servo Motors

The 1FK7 motors are extremely compact, permanent-magnet synchronous motors. The available options, gear units, and encoders, together with the expanded product range, mean that the 1FK7 motors can be optimally adapted to any application. They therefore also satisfy the ever-increasing demands of state-of-the-art machine generations.

Combined with the SIMOVERT MASTERDRIVES Motion Control drive system, 1FK7 motors form a powerful high-performance system. The built-in encoder systems for speed and position control can be selected specifically for the application.

These motors are designed for operation without external cooling whereby generated heat is dissipated through the motor surface. The 1FK7 motors have a high overload capability.

#### Benefits

##### *Features of 1FK7 Compact Motors:*

- Space-saving installation due to their extremely high power density (unit volume as much as 25 % smaller than 1FK6)
- Mechanical compatibility with 1FK6 (shaft, flange and connector)
- Expanded power spectrum

##### *Features of 1FK7 High Dynamic Motors:*

- Extremely high dynamic response due to low rotor moment of inertia
- Mechanical compatibility with 1FK6 (shaft, flange and connector)
- High short-term overload capacity (250 ms)  $M_{\max} = 3 \cdot M_0$  (100 K)

#### Application

- Machine tools
- Robots and handling systems
- Woodworking, glass machining, ceramics, and stoneworking
- Packaging, plastics, and textile machines
- Auxiliary axes

Certain motors are available in core type versions. Compared to the standard models, these core types have the advantage of faster shipping time and spare part delivery. For this reason, we recommend that you configure core types.

# Servo Motors for SIMOVERT MASTERDRIVES

## Synchronous Servo Motors

1FK7 Motors  
Natural cooling

2

### Technical Data

Motor type	Permanent-magnet synchronous motor
Magnet material	Rare-earth magnet material
Insulation of the stator winding in accordance with EN 60034-1 (IEC 60034-1)	Thermal Class F for winding temperature rise of $\Delta T = 100$ K at an ambient temperature of +40 °C (+104 °F).
Construction type in accordance with EN 60034-7 (IEC 60034-7)	IM B5 (IM V1, IM V3)
Degree of protection in accordance with EN 60034-5 (IEC 60034-5)	IP64
Cooling	Natural cooling
Temperature monitoring	KTY 84 temperature sensor in the stator winding
Paint finish	Unpainted
2nd rating plate	Attached to end shield
3rd rating plate	Supplied separately packed
Shaft end on the drive end in accordance with DIN 748-3 (IEC 60072-1)	Keyless shaft
Radial eccentricity, concentricity, and axial eccentricity in accordance with DIN 42955 (IEC 60072-1)	Tolerance N (normal)
Vibration severity in accordance with EN 60034-14 (IEC 60034-14)	Grade N (normal)
Maximum sound pressure level in accordance with EN 1680	1FK702: 55 dB (A) 1FK703: 55 dB (A) 1FK704: 55 dB (A) 1FK706: 65 dB (A) 1FK708: 70 dB (A) 1FK710: 70 dB (A)
Encoder systems, integrated	<ul style="list-style-type: none"> <li>• Incremental encoder sin/cos 1 <math>V_{pp}</math>, 2,048 pulses/revolution</li> <li>• EnDat absolute encoder, 2,048 pulses/revolution for 1FK704 to 1FK710. 512 pulses/revolution for 1FK702 and 1FK703 and traversing range of 4,096 rev</li> <li>• EnDat simple absolute encoder, 32 pulses/revolution for 1FK704 to 1FK710 and traversing range of 4,096 rev</li> <li>• Multipole resolver (number of poles corresponds to number of pole pairs of motor)</li> <li>• Resolver, 2-pole</li> </ul>
Connection	Connectors for signals and power; rotatable (270°)
Options	<ul style="list-style-type: none"> <li>• Shaft end on the drive end with key and keyway (half-key balancing)</li> <li>• Built-in holding brake</li> <li>• Degree of protection IP65, additional IP67 drive-end flange</li> <li>• Planetary gearbox (requires a keyless motor shaft end)</li> <li>• Anthracite-gray finish</li> </ul>

### Characteristics

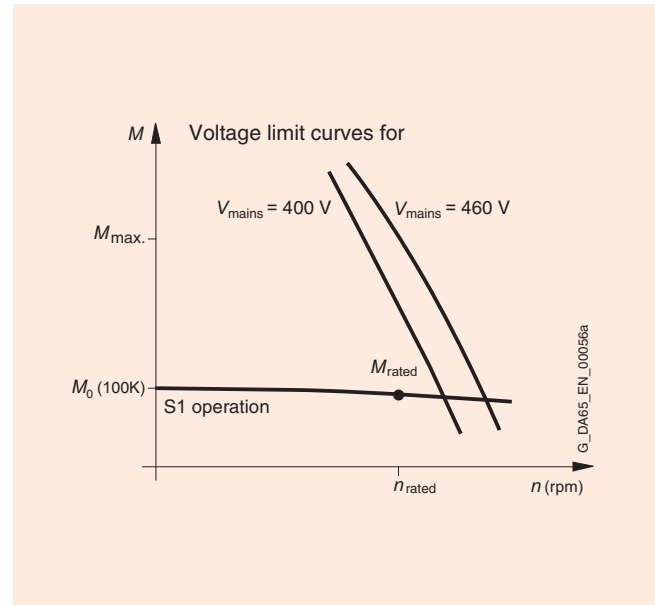

Torque-speed characteristic

### Options

Code	Option description	1FK7 CT	1FK7 HD
<b>M03</b>	Design for Zone 2 hazardous areas (in accordance with EN 50021/IEC 60079-15)	■	■
<b>M39</b>	Design for Zone 22 hazardous areas (in accordance with EN 50281/IEC 61241)	■	■
<b>N05</b>	Atypical shaft end (same dimensions as in 1FT5 motors)	■	■
<b>X01</b>	Jet black finish RAL 9005	■	■
<b>X02</b>	Cream finish RAL 9001	■	■
<b>X03</b>	Reseda green finish RAL 6011	■	■
<b>X04</b>	Pebble gray finish RAL 7032	■	■
<b>X05</b>	Sky blue finish RAL 5015	■	■
<b>X06</b>	Light ivory finish RAL 1015	■	■
<b>X08</b>	White aluminum RAL 9006, suitable for use with food	■	■

■ Option available



# Servo Motors for SIMOVERT MASTERDRIVES

## Synchronous Servo Motors

### 1FK7 Motors Compact, Core Type

Natural cooling

#### Selection and Ordering Data

Rated Rotational Speed	Shaft Height	Rated Output	Rated Torque <sup>1)</sup>	Rated Current	Standstill Torque	<b>1FK7 Synchronous Motors Compact Natural cooling</b>	Pole Pair Number	Rotor Moment of Inertia (w/o Brake)	Weight (without Brake)
$n_{rated}$		$P_{rated}$ at $\Delta T=100$ K	$M_{rated}$ at $\Delta T=100$ K	$I_{rated}$ at $\Delta T=100$ K	$M_0$ at $\Delta T=100$ K	Order No. <b>Core Type</b>		$J$	
rpm	SH	kW (HP)	Nm (lb <sub>f</sub> -in)	A	Nm (lb <sub>f</sub> -in)			10 <sup>-4</sup> kgm <sup>2</sup> (lb <sub>f</sub> -in-s <sup>2</sup> )	kg (lb)
<b>2000</b>	100	7.75 (10.39)	37 (327.5)	16	48 (424.8)	<b>1FK7 105 – 5AC71 – 1 ■■■■</b>	4	156 (0.1381)	39 (85)
<b>3000</b>	48	0.82 (1.1)	2.6 (23)	1.95	3 (26.6)	<b>1FK7 042 – 5AF71 – 1 ■■■■</b>	4	3.01 (0.0027)	4.9 (10.8)
	63	1.48 (1.98)	4.7 (41.6)	3.7	6 (53.1)	<b>1FK7 060 – 5AF71 – 1 ■■■■</b>	4	7.95 (0.0070)	7 (15.4)
		2.29 (3.07)	7.3 (64.6)	5.6	11 (97.4)	<b>1FK7 063 – 5AF71 – 1 ■■■■</b>	4	15.1 (0.0134)	11.5 (25.4)
	80	2.14 (2.87)	6.8 (60.2)	4.4	8 (70.8)	<b>1FK7 080 – 5AF71 – 1 ■■■■</b>	4	15 (0.0133)	10 (22.1)
		3.3 (4.42)	10.5 (92.9)	7.4	16 (141.6)	<b>1FK7 083 – 5AF71 – 1 ■■■■</b>	4	27.3 (0.0242)	14 (30.9)
	100	3.77 (5.05)	12 (106.1)	8	18 (159.3)	<b>1FK7 100 – 5AF71 – 1 ■■■■</b>	4	55.3 (0.0489)	19 (41.9)
		4.87 (6.53)	137.2 (15.5)	11.8	27 (238)	<b>1FK7 101 – 5AF71 – 1 ■■■■</b>	4	79.9 (0.0707)	21 (46.3)
		5.37 <sup>4)</sup> (7.2) <sup>4)</sup>	20.5 <sup>4)</sup> (181.4) <sup>4)</sup>	16.5 <sup>4)</sup>	36 (318.6)	<b>1FK7 103 – 5AF71 – 1 ■■■■</b>	4	105 (0.0929)	29 (63.9)
8.17 (10.95)		26 (230.1)	18	48 (424.8)	<b>1FK7 105 – 5AF71 – 1 ■■■■</b>	4	156 (0.1381)	39 (85)	
<b>4500</b>	63	1.74 (2.33)	3.7 (32.7)	4.1	6 (53.1)	<b>1FK7 060 – 5AH71 – 1 ■■■■</b>	4	7.95 (0.0070)	7 (15.4)
		2.09 <sup>5)</sup> (2.8) <sup>5)</sup>	5 <sup>5)</sup> (44.3) <sup>5)</sup>	6.1 <sup>5)</sup>	11 (97.4)	<b>1FK7 063 – 5AH71 – 1 ■■■■</b>	4	15.1 (0.0134)	11.5 (25.4)
	80	2.39 <sup>5)</sup> (3.2) <sup>5)</sup>	5.7 <sup>5)</sup> (50.5) <sup>5)</sup>	5.6 <sup>5)</sup>	8 (70.8)	<b>1FK7 080 – 5AH71 – 1 ■■■■</b>	4	15 (0.0133)	10 (22.1)
		3.04 <sup>6)</sup> (4.08) <sup>6)</sup>	8.3 <sup>6)</sup> (73.5) <sup>6)</sup>	9 <sup>6)</sup>	16 (141.6)	<b>1FK7 083 – 5AH71 – 1 ■■■■</b>	4	27.3 (0.0242)	14 (30.9)
<b>6000</b>	28	0.4 (0.54)	0.6 (5.3)	1.4	0.85 (7.5)	<b>1FK7 022 – 5AK71 – 1 ■■■■</b>	3	0.0002 (0.28)	1.8 (4)
	36	0.47 (0.63)	0.8 (7.1)	1.4	1.1 (9.7)	<b>1FK7 032 – 5AK71 – 1 ■■■■</b>	3	0.61 (0.0005)	2.7 (6)
	48	0.69 (0.92)	1.1 (9.7)	1.7	1.6 (14.2)	<b>1FK7 040 – 5AK71 – 1 ■■■■</b>	4	1.69 (0.0015)	3.5 (7.7)
		1.05 <sup>7)</sup> (1.41) <sup>7)</sup>	2 <sup>7)</sup> (17.7) <sup>7)</sup>	3.1 <sup>7)</sup>	3 (26.6)	<b>1FK7 042 – 5AK71 – 1 ■■■■</b>	4	3.01 (0.0027)	4.9 (10.8)

• Encoder systems:	Incremental encoder sin/cos 1 V <sub>pp</sub> Absolute encoder EnDat 2,048 pulses/rev <sup>1) 2)</sup> Absolute encoder EnDat 512 pulses/rev <sup>1) 3)</sup> Simple absolute encoder EnDat 32 pulses/rev <sup>1) 2)</sup> Multipole resolver 2-pole resolver	<b>A</b> <b>E</b> <b>H</b> <b>G</b> <b>S</b> <b>T</b>
• Shaft end: With key and keyway With key and keyway Keyless shaft Keyless shaft	• Radial eccentricity tol.: N N N N	• Holding brake: Yes No Yes No
• Degree of protection:	IP64 IP65 and also IP67 drive-end flange IP64, anthracite gray finish IP65 and also IP67 drive-end flange, anthracite finish	<b>A</b> <b>B</b> <b>G</b> <b>H</b>
• Special models: Please specify option code; refer to page 2/3.		<b>0</b> <b>2</b> <b>3</b> <b>5</b>
		<b>-Z</b>

# Servo Motors for SIMOVERT MASTERDRIVES

## Synchronous Servo Motors

1FK7 Motors Compact, Core Type  
Natural cooling

2

### Selection and Ordering Data

Motor Type (continued)	Standstill Current  $I_0$ at $\Delta T=100\text{ K}$ A	SIMOVERT MASTERDRIVES MC Inverter/Converter Rated Current		Power Cable with Complete Shield Motor Connection (with Brake Connection) via Power Connector		
		$I_{\text{rated}}$ A	Order No. Inverter Converter	Power Connector Size	Cable Cross-section Motor <sup>8)</sup> mm <sup>2</sup>	Order No. Pre-Assembled Cable
1FK7 105 – 5AC71 – 1...	20	25.5 20.5	6SE7 022 – 6TP 0 6SE7 022 – 1EP 0	1.5	4 x 2.5	6FX 002 – 5 A31 – ... 0
1FK7 042 – 5AF71 – 1...	2.2	4.0 3.0	6SE7 014 – 0TP 0 6SE7 013 – 0EP 0	1	4 x 1.5	6FX 002 – 5 A01 – ... 0
1FK7 060 – 5AF71 – 1...	4.5	6.1 5.0	6SE7 016 – 0TP 0 6SE7 015 – 0EP 0	1	4 x 1.5	6FX 002 – 5 A01 – ... 0
1FK7 063 – 5AF71 – 1...	8	10.2 8.0	6SE7 021 – 0TP 0 6SE7 018 – 0EP 0	1	4 x 1.5	6FX 002 – 5 A01 – ... 0
1FK7 080 – 5AF71 – 1...	4.8	6.1 5.0	6SE7 016 – 0TP 0 6SE7 015 – 0EP 0	1	4 x 1.5	6FX 002 – 5 A01 – ... 0
1FK7 083 – 5AF71 – 1...	10.4	13.2 10.0	6SE7 021 – 3TP 0 6SE7 021 – 0EP 0	1	4 x 1.5	6FX 002 – 5 A01 – ... 0
1FK7 100 – 5AF71 – 1...	11.2	13.2 14.0	6SE7 021 – 3TP 0 6SE7 021 – 4EP 0	1	4 x 1.5	6FX 002 – 5 A01 – ... 0
1FK7 101 – 5AF71 – 1...	19	25.5 20.5	6SE7 022 – 6TP 0 6SE7 022 – 1EP 0	1.5	4 x 2.5	6FX 002 – 5 A31 – ... 0
1FK7 103 – 5AF71 – 1...	27.5	34.0 34.0	6SE7 023 – 4TP 0 6SE7 023 – 4EP 0	1.5	4 x 4.0	6FX 002 – 5 A41 – ... 0
1FK7 105 – 5AF71 – 1...	31	34.0 34.0	6SE7 023 – 4TP 0 6SE7 023 – 4EP 0	1.5	4 x 10	6FX 002 – 5 A61 – ... 0
1FK7 060 – 5AH71 – 1...	6.2	6.1 8.0	6SE7 016 – 0TP 0 6SE7 018 – 0EP 0	1	4 x 1.5	6FX 002 – 5 A01 – ... 0
1FK7 063 – 5AH71 – 1...	12	13.2 14.0	6SE7 021 – 3TP 0 6SE7 021 – 4EP 0	1	4 x 1.5	6FX 002 – 5 A01 – ... 0
1FK7 080 – 5AH71 – 1...	7.4	10.2 8.0	6SE7 021 – 0TP 0 6SE7 018 – 0EP 0	1	4 x 1.5	6FX 002 – 5 A01 – ... 0
1FK7 083 – 5AH71 – 1...	15	17.5 20.5	6SE7 021 – 8TP 0 6SE7 022 – 1EP 0	1	4 x 1.5	6FX 002 – 5 A01 – ... 0
1FK7 022 – 5AK71 – 1...	1.8	2.0 3.0	6SE7 012 – 0TP 0 6SE7 013 – 0EP 0	1	4 x 1.5	6FX 002 – 5 A01 – ... 0
1FK7 032 – 5AK71 – 1...	1.7	2.0 1.5	6SE7 012 – 0TP 0 6SE7 011 – 5EP 0	1	4 x 1.5	6FX 002 – 5 A01 – ... 0
1FK7 040 – 5AK71 – 1	2.25	4.0 3.0	6SE7 014 – 0TP 0 6SE7 013 – 0EP 0	1	4 x 1.5	6FX 002 – 5 A01 – ... 0
1FK7 042 – 5AK71 – 1...	4.4	6.1 5.0	6SE7 016 – 0TP 0 6SE7 015 – 0EP 0	1	4 x 1.5	6FX 002 – 5 A01 – ... 0
<ul style="list-style-type: none"> <li>• SIMOVERT MASTERDRIVES Motion Control</li> <li>• SIMOVERT MASTERDRIVES Motion Control Performance 2</li> </ul>				5 7		
Power Cable Model						
<ul style="list-style-type: none"> <li>• MOTION-CONNECT 800</li> <li>• MOTION-CONNECT 500</li> </ul>						8 5
<ul style="list-style-type: none"> <li>• Without brake cable</li> <li>• With brake cable</li> </ul>						C D

For information about length codes and signal cables, see "MOTION-CONNECT Connection System", Part 5.

- 1) If the absolute encoder is used,  $M_{\text{rated}}$  is reduced by 10%.
- 2) Not available with 1FK702 and 1FK703
- 3) Not available with 1FK702 and 1FK703
- 4) Rated power/current refers to  $n = 2500$  rpm.
- 5) Rated power/current refers to  $n = 4000$  rpm.
- 6) Rated power/current refers to  $n = 3500$  rpm.

- 7) Rated power/current refers to  $n = 5000$  rpm.
- 8) The current carrying capacity of the power cables corresponds to IEC 60204-1 for Routing Type C under continuous duty conditions at an ambient air temperature of +40 °C (+104 °F), designed for  $I_0$  (100 K) PVC/PUR insulated cable.

# Servo Motors for SIMOVERT MASTERDRIVES

## Synchronous Servo Motors

### 1FK7 High Dynamic Motors, Core Type

Natural cooling

#### Selection and Ordering Data

Rated Rotational Speed	Shaft Height	Rated Output	Rated Torque <sup>1)</sup>	Rated Current	Standstill Torque	<b>1FK7 High Dynamic Synchronous Motors Natural cooling</b>	Pole Pair Number	Rotor Moment of Inertia (w/o Brake)	Weight (without Brake)
$n_{rated}$		$P_{rated}$ at $\Delta T=100$ K	$M_{rated}$ at $\Delta T=100$ K	$I_{rated}$ at $\Delta T=100$ K	$M_0$ at $\Delta T=100$ K	Order No. <b>Core Type</b>		$J$	
rpm	SH	kW (HP)	Nm (lb <sub>f</sub> -in)	A	lb <sub>f</sub> -in (Nm)			10 <sup>-4</sup> kgm <sup>2</sup> (lb <sub>f</sub> -in-s <sup>2</sup> )	kg (lb)
<b>3000</b>	48	1.1 (1.47)	3.5 (31)	4	4 (35.4)	<b>1FK7 044 – 7AF71 – 1 ■■■■</b>	3	1.28 (0.0011)	7.7 (17)
	63	1.7 (2.29)	5.4 (47.8)	5.3	6.4 (56.6)	<b>1FK7 061 – 7AF71 – 1 ■■■■</b>	3	3.4 (0.0030)	10 (22.1)
		2.51 (3.36)	8 (70.8)	7.5	12 (106.2)	<b>1FK7 064 – 7AF71 – 1 ■■■■</b>	3	6.5 (0.0058)	15.5 (34.2)
	80	2.51 (3.36)	8 (70.8)	6.7	14 (123.9)	<b>1FK7 082 – 7AF71 – 1 ■■■■</b>	4	14 (0.0124)	17.2 (37.9)
3.14 <sup>2)</sup> (4.21) <sup>2)</sup>		12 <sup>2)</sup> (106.2) <sup>2)</sup>	12.5 <sup>2)</sup>	22 (194.7)	<b>1FK7 085 – 7AF71 – 1 ■■■■</b>	4	23 (0.0204)	23.5 (51.8)	
<b>4500</b>	48	1.23 (1.65)	2.6 (23)	4	3.1 (27.4)	<b>1FK7 043 – 7AH71 – 1 ■■■■</b>	3	1 (0.0009)	6.7 (14.8)
		1.41 (1.53)	3 (26.6)	4.9	4 (35.4)	<b>1FK7 044 – 7AH71 – 1 ■■■■</b>	3	1.28 (0.0011)	7.7 (17)
	63	2.03 (2.72)	4.3 (38.1)	5.9	6.4 (56.6)	<b>1FK7 061 – 7AH71 – 1 ■■■■</b>	3	3.4 (0.0030)	10 (22.1)
		2.36 (3.16)	5 (44.3)	7	12 (106.2)	<b>1FK7 064 – 7AH71 – 1 ■■■■</b>	3	6.5 (0.0058)	15.5 (34.2)
<b>6000</b>	36	0.57 (0.76)	0.9 (8)	1.5	1.3 (11.5)	<b>1FK7 033 – 7AK71 – 1 ■■■■</b>	3	0.27 (0.0002)	3.1 (6.8)
	48	1.26 (1.69)	2 (17.7)	4.4	3.1 (27.4)	<b>1FK7 043 – 7AK71 – 1 ■■■■</b>	3	1 (0.0009)	6.3 (13.9)
• Encoder systems:			Incremental encoder sin/cos 1 V <sub>pp</sub> Absolute encoder EnDat 2,048 pulses/rev <sup>1) 3)</sup> Absolute encoder EnDat 512 pulses/rev <sup>1) 4)</sup> Simple absolute encoder EnDat 32 pulses/rev <sup>1) 3)</sup> Multipole resolver 2-pole resolver			<b>A E H G S T</b>			
• Shaft end: With key and keyway With key and keyway Keyless shaft Keyless shaft		• Tolerance: N N N N		• Holding brake: Yes No Yes No		<b>A B G H</b>			
• Degree of protection:			IP64 IP65 and also IP67 drive-end flange IP64, anthracite gray finish IP65 and also IP67 drive-end flange, anthracite gray finish			<b>0 2 3 5</b>			
• <b>Special models:</b> Please specify option code; refer to page 2/3.						<b>-Z</b>			

2

# Servo Motors for SIMOVERT MASTERDRIVES

## Synchronous Servo Motors

1FK7 High Dynamic Motors, Core Type  
Natural cooling

2

### Selection and Ordering Data

Motor Type (continued)	Standstill Current  $I_0$ at $\Delta T=100\text{ K}$ A	SIMOVERT MASTERDRIVES MC Inverter/Converter Rated Current		Power Cable with Complete Shield Motor Connection (with Brake Connection) via Power Connector		
		$I_{\text{rated}}$ A	Order No. Inverter Converter	Power Connector Size	Cable Cross-section Motor <sup>5)</sup> mm <sup>2</sup>	Order No. Pre-Assembled Cable
1FK7 044 – 7AF71 – 1...	4.5	6.1 5.0	<b>6SE7 016 – 0TP</b> ■ 0 <b>6SE7 015 – 0EP</b> ■ 0	1	4 x 1.5	<b>6FX</b> ■ 002 – 5 ■ A01 – ... 0
1FK7 061 – 7AF71 – 1...	6.1	6.1 8.0	<b>6SE7 016 – 0TP</b> ■ 0 <b>6SE7 018 – 0EP</b> ■ 0	1	4 x 1.5	<b>6FX</b> ■ 002 – 5 ■ A01 – ... 0
1FK7 064 – 7AF71 – 1...	11	13.2 14	<b>6SE7 021 – 3TP</b> ■ 0 <b>6SE7 021 – 4EP</b> ■ 0	1	4 x 1.5	<b>6FX</b> ■ 002 – 5 ■ A01 – ... 0
1FK7 082 – 7AF71 – 1...	10.6	13.2 14	<b>6SE7 021 – 3TP</b> ■ 0 <b>6SE7 021 – 4EP</b> ■ 0	1	4 x 1.5	<b>6FX</b> ■ 002 – 5 ■ A01 – ... 0
1FK7 085 – 7AF71 – 1...	22.5	25.5 27	<b>6SE7 022 – 6TP</b> ■ 0 <b>6SE7 022 – 7EP</b> ■ 0	1,5	4 x 4	<b>6FX</b> ■ 002 – 5 ■ A41 – ... 0
1FK7 043 – 7AH71 – 1...	4.5	6.1 5.0	<b>6SE7 016 – 0TP</b> ■ 0 <b>6SE7 015 – 0EP</b> ■ 0	1	4 x 1.5	<b>6FX</b> ■ 002 – 5 ■ A01 – ... 0
1FK7 044 – 7AH71 – 1...	6.3	10.2 8.0	<b>6SE7 021 – 0TP</b> ■ 0 <b>6SE7 018 – 0EP</b> ■ 0	1	4 x 1.5	<b>6FX</b> ■ 002 – 5 ■ A01 – ... 0
1FK7 061 – 7AH71 – 1...	8	10.2 8.0	<b>6SE7 021 – 0TP</b> ■ 0 <b>6SE7 018 – 0EP</b> ■ 0	1	4 x 1.5	<b>6FX</b> ■ 002 – 5 ■ A01 – ... 0
1FK7 064 – 7AH71 – 1...	15	17.5 20.5	<b>6SE7 021 – 8TP</b> ■ 0 <b>6SE7 022 – 1EP</b> ■ 0	1	4 x 1.5	<b>6FX</b> ■ 002 – 5 ■ A01 – ... 0
1FK7 033 – 7AK71 – 1...	2.2	4.0 3.0	<b>6SE7 014 – 0TP</b> ■ 0 <b>6SE7 013 – 0EP</b> ■ 0	1	4 x 1.5	<b>6FX</b> ■ 002 – 5 ■ A01 – ... 0
1FK7 043 – 7AK71 – 1...	6.4	10.2 8.0	<b>6SE7 021 – 0TP</b> ■ 0 <b>6SE7 018 – 0EP</b> ■ 0	1	4 x 1.5	<b>6FX</b> ■ 002 – 5 ■ A01 – ... 0
<ul style="list-style-type: none"> <li>• SIMOVERT MASTERDRIVES Motion Control</li> <li>• SIMOVERT MASTERDRIVES Motion Control Performance 2</li> </ul>				5 7		
Power Cable Model						8 5
<ul style="list-style-type: none"> <li>• MOTION-CONNECT 800</li> <li>• MOTION-CONNECT 500</li> </ul>						
For information about signal cables, see "MOTION-CONNECT connection system."						
<ul style="list-style-type: none"> <li>• Without brake cable</li> <li>• With brake cable</li> </ul>						C D

For information about length codes and signal cables, see "MOTION-CONNECT Connection System", Part 5.

1) If the absolute encoder is used,  $M_{\text{rated}}$  is reduced by 10%.  
 2) Rated power/current refers to  $n = 2500$  rpm.  
 3) Not available with 1FK703  
 4) Only available with 1FK703

5) The current carrying capacity of the power cables corresponds to IEC 60204-1 for Routing Type C under continuous duty conditions at an ambient air temperature of +40 °C (+104 °F), designed for  $I_0$  (100 K) PVC/PUR insulated cable.

# Servo Motors for SIMOVERT MASTERDRIVES

## Synchronous Servo Motors

### 1FT6 Motors

#### Overview



1FT6 Synchronous Servo Motors

1FT6 motors are permanent-magnet synchronous motors with compact dimensions.

1FT6 motors with an integrated encoder can be operated on the SIMOVERT MASTERDRIVES Motion Control operating system.

The fully digital control system of the SIMOVERT MASTERDRIVES Motion Control drive system and the encoder technology of the 1FT6 motors fulfill the highest demands in terms of dynamic performance, speed setting range, and rotational and positioning accuracy.

1FT6 motors are available as natural cooled, separately cooled, or water-cooled to match the cooling method used. With the natural cooling method, heat loss is dissipated through the surface, whereas with the forced ventilation method, heat loss is forced out by means of built-on fans. The water cooling method is used to achieve the highest output and fulfill the highest degrees of protection.

#### Benefits

- Optimum surface quality of workpiece due to high rotational accuracy (sinusoidal current injection)
- Short non-productive times due to high dynamic performance
- Power and signal connections for use in severely contaminated areas
- High resistance to lateral force
- Large thermal reserves for continuous load and overload
- High short-term overload capacity (250 ms)
- High level of efficiency
- Very good dynamic response of drive due to low rotor moment of inertia
- Low torque ripple 1% (mean value)
- High degree of protection

#### Application

- High-performance machine tools
- Machines with stringent requirements in terms of dynamic response, precision, and flexibility, e.g., packaging machines, rack feeders, conveyor machines, handling devices, and printing machines.

Certain motors are available in core type versions. Compared to the standard models, these core types have the advantage of faster shipping time and spare part delivery. For this reason, we recommend that you configure core types.

# Servo Motors for SIMOVERT MASTERDRIVES

## Synchronous Servo Motors

1FT6 Motors

2

### Technical Data

Motor type	Permanent-magnet synchronous motor
Magnet material	Rare-earth magnet material
Insulation of the stator winding in accordance with EN 60034-1 (IEC 60034-1)	Temperature class F for a winding temperature rise of $\Delta T = 100$ K at an ambient temperature $+40$ °C ( $+104$ °F) For water-cooled motors, max. inlet temperature of $+30$ °C ( $+86$ °F)
Construction type in accordance with EN 60034-7 (IEC 60034-7)	IM B5 (IM V1, IM V3) IM B14 (IM V18, IM V19) IM B35 for 1FT613. and 1FT616. (Big Servo)
Degrees of protection in accordance with EN 60034-5 (IEC 60034-5)	IP64 standard model, IP65 core type
Cooling	Natural cooling, forced ventilation, water cooling
Temperature monitoring	KTY 84 temperature sensor in stator winding
Paint finish	Anthracite gray
2nd rating plate	Supplied separately packed
Shaft end on the drive end in accordance with DIN 748-3 (IEC 60072-1)	Keyless shaft
Rotational accuracy, concentricity, and axial eccentricity in accordance with DIN 42955 (IEC 60072-1)	Tolerance N (normal)
Vibration severity in accordance with EN 60034-14 (IEC 60034-14)	Grade N (normal)
Max. sound pressure level in accordance with EN 1680	
Natural cooling	1FT602 to 1FT613: 72 dB (A)
Forced ventilation	1FT6100 to 1FT616: 74 dB (A)
Water cooling	70 dB (A)
Encoder system, integrated	<ul style="list-style-type: none"> <li>Incremental encoder sin/cos <math>1 V_{pp}</math>, 2,048 pulses/revolution</li> <li>Absolute encoder EnDat, 2,048 pulses/revolution for 1FT603 to 1FT616., 512 pulses/revolution for 1FT602 and traversing range, 4,096 revolutions</li> <li>Resolver, multipole</li> <li>Resolver, 2-pole</li> </ul>
Connection	<ul style="list-style-type: none"> <li>Connectors for signals and power</li> <li>Terminal box for power connection optional for 1FT610. to 1FT616.</li> </ul>
Options	<ul style="list-style-type: none"> <li>Shaft end on the drive end with featherkey and featherkey way (half-key balancing)</li> <li>Built-in holding brake</li> <li>Degree of protection IP67, IP68 M5 sealing air connection (except for forced ventilation)</li> <li>Planetary gear units, built-on (requirement: keyless motor shaft end and vibration severity grade N)</li> </ul>

### Characteristics

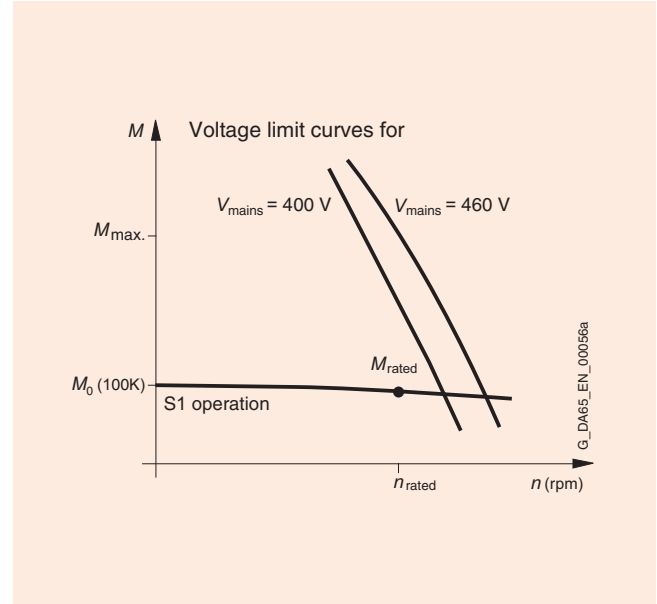

Torque-speed characteristic

### Options

Code	Option Description	1FT6 Natural cooling	Forced ventilation	Water cooling
<b>K09</b>	Terminal box on right-hand side	–	■ (SH 160)	■ (SH 132 and 160)
<b>K10</b>	Terminal box on left-hand side	–	■ (SH 160)	■ (SH 132 and 160)
<b>L68</b>	Full key balancing	–	■ (SH 132 and 160)	■ (SH 132 and 160)
<b>M03</b>	Design for Zone 2 hazardous areas (in accordance with EN 50021/IEC 60079-15)	■ (up to SH 100)	–	■ (SH 63 and 100)
<b>M39</b>	Design for Zone 22 hazardous areas (in accordance with EN 50281/IEC 61241)	■ (up to SH 100)	–	–
<b>N05</b>	Atypical shaft end (same dimensions as in 1FT5)	■	–	–
<b>N40</b>	Food industry design	■ (SH 63 and 100)	–	–
<b>X01</b>	Jet black finish RAL 9005	■	■	■
<b>X02</b>	Cream finish RAL 9001	■	■	■
<b>X03</b>	Reseda green finish RAL 6011	■	■	■
<b>X04</b>	Pebble gray finish RAL 7032	■	■	■
<b>X05</b>	Sky blue finish RAL 5015	■	■	■
<b>X06</b>	Light ivory finish RAL 1015	■	■	■

■ Option available  
– Not available



# Servo Motors for SIMOVERT MASTERDRIVES

## Synchronous Servo Motors

### 1FT6 Motors, Core Type Natural cooling

#### Selection and Ordering Data

Rated Rotational Speed	Shaft Height	Rated Output	Rated Torque <sup>1)</sup>	Rated Current	Standstill Torque	1FT6 Servo Motors Natural cooling	Pole Pair Number	Rotor Moment of Inertia (w/o Brake)	Weight (without Brake)
$n_{rated}$		$P_{rated}$ at $\Delta T=100$ K	$M_{rated}$ at $\Delta T=100$ K	$I_{rated}$ at $\Delta T=100$ K	$M_0$ at $\Delta T=100$ K	Order No. Core Type		$J$	
rpm	SH	kW (HP)	Nm (lb <sub>f</sub> -in)	A	Nm (lb <sub>f</sub> -in)			10 <sup>-4</sup> kgm <sup>2</sup> (lb <sub>f</sub> -in-s <sup>2</sup> )	kg (lb)
2000	100	4.8 (6.43)	23 (203.6)	11	27 (239)	1FT6 102 – 1AC71 – ■■■■ 1	4	99 (0.0876)	27.5 (60.6)
		8.0 (10.72)	38 (336.3)	17.6	50 (442.6)	1FT6 105 – 1AC71 – ■■■■ 1	4	168 (0.1487)	39.5 (87.1)
3000	48	1.4 (1.88)	4.3 (38.1)	2.9	5 (44.3)	1FT6 044 – 1AF71 – ■■■■ 1	2	5.1 (0.0045)	8.3 (18.3)
		63	1.5 (2.01)	4.7 (41.6)	3.4	6 (53.1)	1FT6 062 – 1AF71 – ■■■■ 1	3	8.5 (0.0752)
	2.2 (2.95)		7 (62)	4.9	9.5 (84.1)	1FT6 064 – 1AF71 – ■■■■ 1	3	13 (0.0115)	12.5 (27.6)
	80	3.2 (4.29)	10.3 (91.2)	8.7	13 (115.1)	1FT6 082 – 1AF71 – ■■■■ 1	4	30 (0.0266)	15 (33.1)
		4.6 (6.17)	14.7 (130.1)	11	20 (177)	1FT6 084 – 1AF71 – ■■■■ 1	4	48 (0.0425)	20.5 (45.2)
		5.8 (7.77)	18.5 (163.7)	13	27 (239)	1FT6 086 – 1AF71 – ■■■■ 1	4	66.5 (0.0589)	25.5 (56.2)
4500	63	1.7 (2.28)	3.6 (31.9)	3.9	6 (53.1)	1FT6 062 – 1AH71 – ■■■■ 1	3	8.5 (0.0752)	9.5 (20.9)
		2.3 (3.08)	4.8 (42.5)	5.5	9.5 (84.1)	1FT6 064 – 1AH71 – ■■■■ 1	3	13 (0.0115)	12.5 (27.6)
	80	4.9 (6.57)	10.5 (92.9)	12.5	20 (177)	1FT6 084 – 1AH71 – ■■■■ 1	4	48 (0.0425)	20.5 (45.2)
		5.7 (7.64)	12 (106.2)	12.6	27 (239)	1FT6 086 – 1AH71 – ■■■■ 1	4	66.5 (0.0589)	25.5 (56.2)
6000	36	0.88 (1.18)	1.4 (12.4)	2.1	2 (17.7)	1FT6 034 – 1AK71 – ■■■■ 1	2	1.1 (0.0010)	4.4 (9.7)
	80	4.1 (5.5)	6.5 (57.5)	9.2	20 (177)	1FT6 084 – 1AK71 – ■■■■ 1	4	48 (0.0425)	20.5 (45.2)

- Connector outlet direction: Transverse right (not for 1FT604, 1FT606) **1**  
Transverse left (not for 1FT604, 1FT606) **2**  
Axial non-drive end **3**  
Axial drive-end **4**
- Encoder systems: Incremental encoder sin/cos 1 V<sub>pp</sub> **A**  
Absolute encoder EnDat, 2,048 pulses/revolution <sup>1)</sup> **E**
- Keyless shaft / Radial eccentricity tolerance N: Without holding brake **G**  
With holding brake **H**

# Servo Motors for SIMOVERT MASTERDRIVES

## Synchronous Servo Motors

1FT6 Motors, Core Type  
Natural cooling

2

### Selection and Ordering Data

Motor Type (continued)	Standstill Current  $I_0$ at $\Delta T=100\text{ K}$ A	SIMOVERT MASTERDRIVES MC Inverter/Converter Rated Current		Power Cable with Complete Shield Motor Connection with Brake Connection via Power Connector		
		$I_{\text{rated}}$ A	Order No. Inverter Converter	Power Connector Size	Cable Cross-section Motor <sup>2)</sup> mm <sup>2</sup>	Order No. Pre-Assembled Cable
1FT6 102 – 1AC71 – ....	12.1	13.2 14	6SE7 021 – 3T P 0 6SE7 021 – 4E P 0	1.5	4 x 1.5	6FX 002 – 5 A21 – ... 0
1FT6 105 – 1AC71 – ....	21.4	25.5 27	6SE7 022 – 6T P 0 6SE7 022 – 7E P 0	1.5	4 x 4	6FX 002 – 5 A41 – ... 0
1FT6 044 – 1AF71 – ....	3	4 3	6SE7 014 – 0T P 0 6SE7 013 – 0E P 0	1	4 x 1.5	6FX 002 – 5 A01 – ... 0
1FT6 062 – 1AF71 – ....	4.1	4 5	6SE7 014 – 0T P 0 6SE7 015 – 0E P 0	1	4 x 1.5	6FX 002 – 5 A01 – ... 0
1FT6 064 – 1AF71 – ....	6.1	6.1 8	6SE7 016 – 0T P 0 6SE7 018 – 0T P 0	1	4 x 1.5	6FX 002 – 5 A01 – ... 0
1FT6 082 – 1AF71 – ....	9.6	10.2 10	6SE7 021 – 0T P 0 6SE7 021 – 0E P 0	1.5	4 x 1.5	6FX 002 – 5 A21 – ... 0
1FT6 084 – 1AF71 – ....	13.2	17.5 14	6SE7 021 – 8T P 0 6SE7 021 – 4E P 0	1.5	4 x 1.5	6FX 002 – 5 A21 – ... 0
1FT6 086 – 1AF71 – ....	16.4	17.5 20.5	6SE7 021 – 8T P 0 6SE7 022 – 1E P 0	1.5	4 x 2.5	6FX 002 – 5 A31 – ... 0
1FT6 062 – 1AH71 – ....	5.7	6.1 8	6SE7 016 – 0T P 0 6SE7 018 – 0E P 0	1	4 x 1.5	6FX 002 – 5 A01 – ... 0
1FT6 064 – 1AH71 – ....	9.0	10.2 10	6SE7 021 – 0T P 0 6SE7 021 – 0E P 0	1	4 x 1.5	6FX 002 – 5 A01 – ... 0
1FT6 084 – 1AH71 – ....	19.8	25.5 20.5	6SE7 022 – 6T P 0 6SE7 022 – 1E P 0	1.5	4 x 4	6FX 002 – 5 A41 – ... 0
1FT6 086 – 1AH71 – ....	23.3	25.5 27	6SE7 022 – 6T P 0 6SE7 022 – 7E P 0	1.5	4 x 4	6FX 002 – 5 A41 – ... 0
1FT6 034 – 1AK71 – ....	2.6	4 3	6SE7 014 – 0T P 0 6SE7 013 – 0E P 0	1	4 x 1.5	6FX 002 – 5 A01 – ... 0
1FT6 084 – 1AK71 – ....	24.1	25.5 27	6SE7 022 – 6T P 0 6SE7 022 – 7E P 0	1.5	4 x 4	6FX 002 – 5 A41 – ... 0
• Compact PLUS				P		
• SIMOVERT MASTERDRIVES Motion Control				5		
• SIMOVERT MASTERDRIVES Motion Control Performance 2				7		
Power Cable Model						
• MOTION-CONNECT 800						8
• MOTION-CONNECT 500						5
• Without brake cable						C
• With brake cable						D

For information about length codes and signal cables, see "MOTION-CONNECT Connection System", Part 5.

1) If the absolute encoder is used,  $M_{\text{rated}}$  is reduced by 10%.

2) The current carrying capacity of the power cables corresponds to IEC 60204-1 for Routing Type C under continuous duty conditions at an ambient air temperature of +40 °C (+104 °F), designed for  $I_0$  (100 K) PVC/PUR insulated cable.

# Servo Motors for SIMOVERT MASTERDRIVES

## Synchronous Servo Motors

### 1FT6 Motors Natural cooling

#### Selection and Ordering Data

Rated Rotational Speed	Shaft Height	Rated Output	Rated Torque <sup>1)</sup>	Rated Current	Standstill Torque	1FT6 Servo Motors Natural cooling	Pole Pair Number	Rotor Moment of Inertia (w/o Brake)	Weight (w/o Brake)
$n_{rated}$		$P_{rated}$ at $\Delta T=100\text{ K}$	$M_{rated}$ at $\Delta T=100\text{ K}$	$I_{rated}$ at $\Delta T=100\text{ K}$	$M_0$ at $\Delta T=100\text{ K}$	Order No. Standard Model		$J$	
rpm	SH	kW (HP)	Nm (lb <sub>f</sub> -in)	A	Nm (lb <sub>f</sub> -in)			10 <sup>-4</sup> kgm <sup>2</sup> (lb <sub>f</sub> -in-s <sup>2</sup> )	kg (lb)
1500	100	3.8 (5.09)	24.5 (216.8)	8.4	27 (239)	1FT6 102 – 8AB7 – ■■■■■	4	99 (0.0876)	27.5 (60.6)
		6.4 (8.59)	41 (362.9)	14.5	50 (442.6)	1FT6 105 – 8AB7 – ■■■■■	4	168 (0.1487)	39.5 (87.1)
		9.6 (12.87)	61 (539.9)	20.5	70 (619.6)	1FT6 108 – 8AB7 – ■■■■■	4	260 (0.2301)	55.5 (122.4)
	132	9.7 (13)	62 (548.8)	19	75 (663.8)	1FT6 132 – 6AB7 1 – ■■■■■	3	430 (0.3806)	85 (187.4)
		11.8 (15.82)	75 (663.8)	24	95 (840.8)	1FT6 134 – 6AB7 1 – ■■■■■	3	547 (0.4841)	100 (220.5)
		13.8 (18.5)	88 (778.9)	27	115 (1017.9)	1FT6 136 – 6AB7 1 – ■■■■■	3	664 (0.5876)	117 (258)

• Construction type:	IM B5 IM B14 <sup>2)</sup> (not for 1FT613)	1 2
• Connector outlet direction:	Transverse right Transverse left Axial non-drive end (not for 1FT613) Axial drive end	1 2 3 4
• Terminal box, Cable entry:	Transverse right Transverse left Axial non-drive end Axial drive end	5 6 7 8
• Encoder systems:	Incremental encoder sin/cos 1 V <sub>pp</sub> Absolute encoder EnDat, 2,048 pulses/revolution <sup>1)</sup> Resolver, multipole Resolver, 2-pole	A E S T
• Shaft end:	• Radial eccentricity tol.:	• Holding brake:
With key and keyway	N	No
With key and keyway	N	Yes
With key and keyway	R	No
With key and keyway	R	Yes
Keyless shaft	N	No
Keyless shaft	N	Yes
Keyless shaft	R	No
Keyless shaft	R	Yes
• Vibration severity grade:		• Degree of protection:
N		IP64
N		IP65
N		IP67
N		IP68
R		IP64
R		IP65
R		IP67
R		IP68
• Special models:		
Please specify option code; refer to page 2/9.		0 1 2 6 3 4 5 7 -Z

# Servo Motors for SIMOVERT MASTERDRIVES

## Synchronous Servo Motors

1FT6 Motors  
Natural cooling

2

### Selection and Ordering Data

Motor Type (continued)	Standstill Current  $I_0$ at $\Delta T=100\text{ K}$ A	SIMOVERT MASTERDRIVES MC Inverter/Converter Rated Current		Power Cable with Complete Shield Motor Connection with Brake Connection via Power Connector		
		$I_{\text{rated}}$ A	Order No. Inverter Converter	Power Connector Size	Cable Cross-section Motor <sup>3)</sup> mm <sup>2</sup>	Order No. Pre-Assembled Cable
1FT6 102 – 8AB7 . – ....	8.7	10.2 10	<b>6SE7 021 – 0 T P ■ 0</b> <b>6SE7 021 – 0 E P ■ 0</b>	1.5	4 x 1.5	<b>6FX ■ 002 – 5 ■ A21 – . . . 0</b>
1FT6 105 – 8AB7 . – ....	16.0	17.5 20.5	<b>6SE7 021 – 8 T P ■ 0</b> <b>6SE7 022 – 1 E P ■ 0</b>	1.5	4 x 2.5	<b>6FX ■ 002 – 5 ■ A31 – . . . 0</b>
1FT6 108 – 8AB7 . – ....	22.3	25.5 27	<b>6SE7 022 – 6 T P ■ 0</b> <b>6SE7 022 – 7 E P ■ 0</b>	1.5	4 x 4	<b>6FX ■ 002 – 5 ■ A41 – . . . 0</b>
1FT6 132 – 6AB71 – ....	21.6	25.5 27	<b>6SE7 022 – 6 T P ■ 0</b> <b>6SE7 022 – 7 E P ■ 0</b>	1.5	4 x 4	<b>6FX ■ 002 – 5 ■ A41 – . . . 0</b>
1FT6 134 – 6AB71 – ....	27	34 27	<b>6SE7 023 – 4 T P ■ 0</b> <b>6SE7 022 – 7 E P ■ 0</b>	1.5	4 x 4	<b>6FX ■ 002 – 5 ■ A41 – . . . 0</b>
1FT6 136 – 6AB71 – ....	34	34 34	<b>6SE7 023 – 4 T P ■ 0</b> <b>6SE7 023 – 4 E P ■ 0</b>	1.5	4 x 6	<b>6FX ■ 002 – 5 ■ A51 – . . . 0</b>
<ul style="list-style-type: none"> <li>• Converter</li> <li>• Inverter</li> </ul>				<b>E</b>		
<ul style="list-style-type: none"> <li>• Compact PLUS</li> </ul>				<b>P</b>		
<ul style="list-style-type: none"> <li>• SIMOVERT MASTERDRIVES Motion Control</li> <li>• SIMOVERT MASTERDRIVES Motion Control Performance 2</li> </ul>				<b>5</b>		
<ul style="list-style-type: none"> <li>• Without brake cable</li> <li>• With brake cable</li> </ul>						<b>C</b>
<ul style="list-style-type: none"> <li>• MOTION-CONNECT 800</li> <li>• MOTION-CONNECT 500</li> </ul>					<b>8</b>	<b>5</b>
						<b>D</b>

For information about length codes and signal cables, see "MOTION-CONNECT Connection System", Part 5.

1) If the absolute encoder is used,  $M_{\text{rated}}$  is reduced by 10%.  
2) Same flange as IM B5, but with a helicoil in the four mounting holes.

3) The current carrying capacity of the power cables corresponds to IEC 60204-1 for Routing Type C under continuous duty conditions at an ambient air temperature of +40 °C (+104 °F), designed for  $I_0$  (100 K) PVC/PUR insulated cable.

# Servo Motors for SIMOVERT MASTERDRIVES

## Synchronous Servo Motors

### 1FT6 Motors Natural cooling

#### Selection and Ordering Data

Rated Rotational Speed	Shaft Height	Rated Output	Rated Torque <sup>1)</sup>	Rated Current	Standstill Torque	1FT6 Servo Motors Natural cooling	Pole Pair Number	Rotor Moment of Inertia (w/o Brake)	Weight (w/o Brake)
$n_{rated}$		$P_{rated}$ at $\Delta T=100$ K	$M_{rated}$ at $\Delta T=100$ K	$I_{rated}$ at $\Delta T=100$ K	$M_0$ at $\Delta T=100$ K	Order No. Standard Model		$J$	
rpm	SH	kW (HP)	Nm (lb <sub>f</sub> -in)	A	Nm (lb <sub>f</sub> -in)			$10^{-4}$ kgm <sup>2</sup> (lb <sub>f</sub> -in-s <sup>2</sup> )	kg (lb)
2000	63	0.8 (1.07)	3.7 (32.7)	1.9	4 (35.4)	1FT6 061 – 6AC7 – ■■■■■■	3	6 (0.0053)	8 (17.6)
		1.1 (1.47)	5.2 (46)	2.6	6 (53.1)	1FT6 062 – 6AC7 – ■■■■■■	3	8.5 (0.0075)	9.5 (20.9)
		1.7 (2.28)	8 (70.8)	3.8	9.5 (84.1)	1FT6 064 – 6AC7 – ■■■■■■	3	13 (0.0115)	12.5 (27.6)
	80	1.6 (2.14)	7.5 (66.4)	4.1	8 (70.8)	1FT6 081 – 8AC7 – ■■■■■■	4	21 (0.0186)	12.5 (27.6)
		2.4 (3.22)	11.4 (100.9)	6.6	13 (115.1)	1FT6 082 – 8AC7 – ■■■■■■	4	30 (0.0266)	15 (33.1)
		3.5 (4.69)	16.9 (149.6)	8.3	20 (177)	1FT6 084 – 8AC7 – ■■■■■■	4	48 (0.0425)	20.5 (45.2)
		4.7 (6.3)	22.5 (199.1)	10.9	27 (239)	1FT6 086 – 8AC7 – ■■■■■■	4	66.5 (0.0589)	25.5 (56.2)
	100	4.8 (6.43)	23 (203.6)	11	27 (239)	1FT6 102 – 8AC7 – ■■■■■■	4	99 (0.0876)	27.5 (60.6)
		8.0 (10.72)	38 (336.3)	17.6	50 (203.6)	1FT6 105 – 8AC7 – ■■■■■■	4	168 (0.1487)	39.5 (87.1)
		11.5 (15.42)	55 (486.8)	24.5	70 (620)	1FT6 108 – 8AC7 – ■■■■■■	4	260 (0.2301)	55.5 (122.4)
	132	11.5 (15.42)	55 (486.8)	23	75 (663.8)	1FT6 132 – 6AC7 1 – ■■■■■■	3	430 (0.3806)	85 (187.4)
		13.6 (18.23)	65 (575.3)	27	95 (840.8)	1FT6 134 – 6AC7 1 – ■■■■■■	3	547 (0.4841)	100 (220.5)
15.5 (20.78)		74 (655)	30	115 (1017.9)	1FT6 136 – 6AC7 1 – ■■■■■■	3	664 (0.5876)	117 (258)	

• Construction type:	IM B5 IM B14 <sup>2)</sup> (not for 1FT613)	1 2
• Connector outlet direction:	Transverse right (not for 1FT606) Transverse left (not for 1FT606) Axial non-drive end (not for 1FT613) Axial drive end	1 2 3 4
• Terminal box, Cable entry (only for 1FT61..):	Transverse right Transverse left Axial non-drive end Axial drive end	5 6 7 8
• Encoder systems:	Incremental encoder sin/cos 1 V <sub>pp</sub> Absolute encoder EnDat, 2,048 pulses/revolution <sup>1)</sup> Resolver, multipole Resolver, 2-pole	A E S T
• Shaft end: With key and keyway With key and keyway With key and keyway With key and keyway Keyless shaft Keyless shaft Keyless shaft Keyless shaft	• Radial eccentricity tol.: N N R R N N R R R	A B D E G H K L
• Holding brake:	No Yes No Yes No Yes No Yes	
• Vibration severity grade: N N N N R R R R	• Degree of protection: IP64 IP65 IP67 IP68 IP64 IP65 IP67 IP68	0 1 2 6 3 4 5 7
• Special models: Please specify option code; refer to page 2/9.		–Z

# Servo Motors for SIMOVERT MASTERDRIVES

## Synchronous Servo Motors

1FT6 Motors  
Natural cooling

2

### Selection and Ordering Data

Motor Type (continued)	Standstill Current  $I_0$ at $\Delta T=100\text{ K}$ A	SIMOVERT MASTERDRIVES MC Inverter/Converter Rated Current		Power Cable with Complete Shield Motor Connection with Brake Connection via Power Connector		
		$I_{\text{rated}}$ A	Order No. Inverter Converter	Power Connector Size	Cable Cross-section Motor <sup>3)</sup> mm <sup>2</sup>	Order No. Pre-Assembled Cable
1FT6 061 – 6AC7 . – ....	1.9	2 3	6SE7 012 – 0 T P 0 6SE7 013 – 0 E P 0	1	4 x 1.5	6FX 002 – 5 A01 – ... 0
1FT6 062 – 6AC7 . – ....	2.7	4 3	6SE7 014 – 0 T P 0 6SE7 013 – 0 E P 0	1	4 x 1.5	6FX 002 – 5 A01 – ... 0
1FT6 064 – 6AC7 . – ....	4.2	6.1 5	6SE7 016 – 0 T P 0 6SE7 015 – 0 E P 0	1	4 x 1.5	6FX 002 – 5 A01 – ... 0
1FT6 081 – 8AC7 . – ....	3.9	4 5	6SE7 014 – 0 T P 0 6SE7 015 – 0 E P 0	1.5	4 x 1.5	6FX 002 – 5 A21 – ... 0
1FT6 082 – 8AC7 . – ....	6.6	10.2 8	6SE7 021 – 0 T P 0 6SE7 018 – 0 E P 0	1.5	4 x 1.5	6FX 002 – 5 A21 – ... 0
1FT6 084 – 8AC7 . – ....	8.8	10.2 10	6SE7 021 – 0 T P 0 6SE7 021 – 0 E P 0	1.5	4 x 1.5	6FX 002 – 5 A21 – ... 0
1FT6 086 – 8AC7 . – ....	11.3	13.2 14	6SE7 021 – 3 T P 0 6SE7 021 – 4 E P 0	1.5	4 x 1.5	6FX 002 – 5 A21 – ... 0
1FT6 102 – 8AC7 . – ....	12.1	13.2 14	6SE7 021 – 3 T P 0 6SE7 021 – 4 E P 0	1.5	4 x 1.5	6FX 002 – 5 A21 – ... 0
1FT6 105 – 8AC7 . – ....	21.4	25.5 27	6SE7 022 – 6 T P 0 6SE7 022 – 7 E P 0	1.5	4 x 4	6FX 002 – 5 A41 – ... 0
1FT6 108 – 8AC7 . – ....	29	34 34	6SE7 023 – 4 T P 0 6SE7 023 – 4 E P 0	1.5	4 x 6	6FX 002 – 5 A51 – ... 0
1FT6 132 – 6AC71 – ....	29	34 34	6SE7 023 – 4 T P 0 6SE7 023 – 4 E P 0	1.5	4 x 6	6FX 002 – 5 A51 – ... 0
1FT6 134 – 6AC71 – ....	36	37.5 37.5	6SE7 023 – 8 T P 0 6SE7 023 – 8 E D 1	1.5	4 x 10	6FX 002 – 5 A61 – ... 0
1FT6 136 – 6AC71 – ....	42	47 47	6SE7 024 – 7 T D 1 6SE7 024 – 7 E D 1	3	4 x 10	6FX 002 – 5 A13 – ... 0

• Converter	<b>E</b>
• Inverter	<b>T</b>
• P for Compact PLUS, D for Compact devices	<b>P</b> <b>D</b>
• SIMOVERT MASTERDRIVES Motion Control	<b>5</b>
• SIMOVERT MASTERDRIVES Motion Control Performance 2	<b>7</b>
Power Cable Model	
• MOTION-CONNECT 800	<b>8</b>
• MOTION-CONNECT 500	<b>5</b>
• Without brake cable	<b>C</b>
• With brake cable	<b>D</b>

For information about length codes and signal cables, see "MOTION-CONNECT Connection System", Part 5.

1) If the absolute encoder is used,  $M_{\text{rated}}$  is reduced by 10%.  
2) Same flange as IM B5, but with a helicoil in the four mounting holes.

3) The current carrying capacity of the power cables corresponds to IEC 60204-1 for Routing Type C under continuous duty conditions at an ambient air temperature of +40 °C (+104 °F), designed for  $I_0$  (100 K) PVC/PUR insulated cable.



# Servo Motors for SIMOVERT MASTERDRIVES

## Synchronous Servo Motors

### 1FT6 Motors Natural cooling

#### Selection and Ordering Data

Rated Rotational Speed	Shaft Height	Rated Output	Rated Torque <sup>1)</sup>	Rated Current	Standstill Torque	1FT6 Servo Motors Natural cooling	Pole Pair Number	Rotor Moment of Inertia (w/o Brake)	Weight (w/o Brake)
$n_{rated}$		$P_{rated}$ at $\Delta T=100\text{ K}$	$M_{rated}$ at $\Delta T=100\text{ K}$	$I_{rated}$ at $\Delta T=100\text{ K}$	$M_0$ at $\Delta T=100\text{ K}$	Order No. Standard Model		$J$	
rpm	SH	kW (HP)	Nm (lb <sub>f</sub> -in)	A	Nm (lb <sub>f</sub> -in)			$10^{-4}\text{ kgm}^2$ (lb <sub>f</sub> -in-s <sup>2</sup> )	kg (lb)
3000	48	0.7 (0.99)	2.15 (19)	1.7	2.6 (23)	<b>1FT6 041 – 4AF7 1 – ■■■■</b>	2	2.9 (0.0025)	6.6 (14.6)
		1.4 (1.88)	4.3 (38.1)	2.9	5 (44.3)	<b>1FT6 044 – 4AF7 1 – ■■■■</b>	2	5.1 (0.0045)	8.3 (18.3)
	63	1.1 (1.47)	3.5 (31)	2.6	4 (35.4)	<b>1FT6 061 – 6AC7 ■ – ■■■■</b>	3	6 (0.0053)	8 (17.6)
		1.5 (2.01)	4.7 (41.6)	3.4	6 (53.1)	<b>1FT6 062 – 6AC7 ■ – ■■■■</b>	3	8.5 (0.0075)	9.5 (20.9)
		2.2 (2.95)	7 (62)	4.9	9.5 (84.1)	<b>1FT6 064 – 6AF7 ■ – ■■■■</b>	3	13 (0.0115)	12.5 (27.6)
	80	2.2 (2.95)	6.9 (61.1)	5.6	8 (70.8)	<b>1FT6 081 – 8AF7 ■ – ■■■■</b>	4	21 (0.0186)	12.5 (27.6)
		3.2 (4.29)	10.3 (91.2)	8.7	13 (115.1)	<b>1FT6 082 – 8AF7 ■ – ■■■■</b>	4	30 (0.0266)	15 (33.1)
		4.6 (6.17)	14.7 (130.1)	11	20 (177)	<b>1FT6 084 – 8AF7 ■ – ■■■■</b>	4	48 (0.0425)	20.5 (45.2)
		5.8 (7.77)	18.5 (163.7)	13	27 (239)	<b>1FT6 086 – 8AF7 ■ – ■■■■</b>	4	66.5 (0.0589)	25.5 (56.2)
	100	6.1 (8.18)	19.5 (172.6)	13.2	27 (239)	<b>1FT6 102 – 8AF7 ■ – ■■■■</b>	4	99 (0.0876)	27.5 (60.6)
		9.7 (13)	31 (274.4)	22.5	50 (442.6)	<b>1FT6 105 – 8AF7 ■ – ■■■■</b>	4	168 (0.1487)	39.5 (87.1)
		11.6 (15.55)	37 (327.5)	25	70 (619.6)	<b>1FT6 108 – 8AF7 ■ – ■■■■</b>	4	260 (0.2301)	55.5 (122.4)
132	11.3 (15.15)	36 (318.6)	23	75 (663.8)	<b>1FT6 132 – 6AF7 1 – ■■■■</b>	3	430 (0.3806)	85 (187.4)	

• Construction type:	IM B5 IM B14 <sup>2)</sup> (not for 1FT604, 1FT613)	1 2
• Connector outlet direction:	Transverse right (not for 1FT604, 1FT606) Transverse left (not for 1FT604, 1FT606) Axial non-drive end (not for 1FT613) Axial drive end	1 2 3 4
• Terminal box, Cable entry (only for 1FT61..):	Transverse right Transverse left Axial non-drive end Axial drive end	5 6 7 8
• Encoder systems:	Incremental encoder sin/cos 1 V <sub>pp</sub> Absolute encoder EnDat, 2,048 pulses/revolution <sup>1)</sup> Resolver, multipole Resolver, 2-pole	A E S T
• Shaft end: With key and keyway With key and keyway With key and keyway With key and keyway Keyless shaft Keyless shaft Keyless shaft Keyless shaft	• Radial eccentricity tol.: N N R R N N R R	A B D E G H K L
• Holding brake:	No Yes No Yes No Yes No Yes	
• Vibration severity grade: N N N N R R R R	• Degree of protection: IP64 IP65 IP67 IP68 IP64 IP65 IP67 IP68	0 1 2 6 3 4 5 7
• Special models: Please specify option code; refer to page 2/9.		–Z

2

# Servo Motors for SIMOVERT MASTERDRIVES

## Synchronous Servo Motors

1FT6 Motors  
Natural cooling

2

### Selection and Ordering Data

Motor Type (continued)	Standstill Current  $I_0$ at $\Delta T=100\text{ K}$ A	SIMOVERT MASTERDRIVES MC Inverter/Converter Rated Current		Power Cable with Complete Shield Motor Connection with Brake Connection via Power Connector		
		$I_{\text{rated}}$ A	Order No. Inverter Converter	Power Connector Size	Cable Cross-section Motor <sup>3)</sup> mm <sup>2</sup>	Order No. Pre-Assembled Cable
1FT6 041 – 4AF71 – ....	1.9	2 3	6SE7 012 – 0 T P ■ 0 6SE7 013 – 0 E P ■ 0	1	4 x 1.5	6FX ■ 002 – 5 ■ A01 – ... 0
1FT6 044 – 4AF71 – ....	3	4 3	6SE7 014 – 0 T P ■ 0 6SE7 013 – 0 E P ■ 0	1	4 x 1.5	6FX ■ 002 – 5 ■ A01 – ... 0
1FT6 061 – 6AF7. – ....	2.7	4 3	6SE7 014 – 0 T P ■ 0 6SE7 013 – 0 E P ■ 0	1	4 x 1.5	6FX ■ 002 – 5 ■ A01 – ... 0
1FT6 062 – 6AF7. – ....	4.1	4 5	6SE7 014 – 0 T P ■ 0 6SE7 015 – 0 E P ■ 0	1	4 x 1.5	6FX ■ 002 – 5 ■ A01 – ... 0
1FT6 064 – 6AF7. – ....	6.1	6.1 8	6SE7 016 – 0 T P ■ 0 6SE7 018 – 0 E P ■ 0	1	4 x 1.5	6FX ■ 002 – 5 ■ A01 – ... 0
1FT6 081 – 8AF7. – ....	5.8	6.1 8	6SE7 016 – 0 T P ■ 0 6SE7 018 – 0 E P ■ 0	1.5	4 x 1.5	6FX ■ 002 – 5 ■ A21 – ... 0
1FT6 082 – 8AF7. – ....	9.6	10.2 10	6SE7 021 – 0 T P ■ 0 6SE7 021 – 0 E P ■ 0	1.5	4 x 1.5	6FX ■ 002 – 5 ■ A21 – ... 0
1FT6 084 – 8AF7. – ....	13.2	17.5 14	6SE7 021 – 8 T P ■ 0 6SE7 021 – 4 E P ■ 0	1.5	4 x 1.5	6FX ■ 002 – 5 ■ A21 – ... 0
1FT6 086 – 8AF7. – ....	16.4	17.5 20.5	6SE7 021 – 8 T P ■ 0 6SE7 022 – 1 E P ■ 0	1.5	4 x 2.5	6FX ■ 002 – 5 ■ A31 – ... 0
1FT6 102 – 8AF7. – ....	16.9	17.5 20.5	6SE7 021 – 8 T P ■ 0 6SE7 022 – 1 E P ■ 0	1.5	4 x 2.5	6FX ■ 002 – 5 ■ A31 – ... 0
1FT6 105 – 8AF7. – ....	32	34 34	6SE7 023 – 4 T P ■ 0 6SE7 023 – 4 E D ■ 0	1.5	4 x 6	6FX ■ 002 – 5 ■ A51 – ... 0
1FT6 108 – 8AF7. – ....	41	47 47	6SE7 024 – 7 T D ■ 1 6SE7 024 – 7 E D ■ 1	3	4 x 10	6FX ■ 002 – 5 ■ A13 – ... 0
1FT6 132 – 6AF71 – ....	43	47 47	6SE7 024 – 7 T D ■ 1 6SE7 024 – 7 E D ■ 1	3	4 x 10	6FX ■ 002 – 5 ■ A13 – ... 0

• Converter	<b>E</b>
• Inverter	<b>T</b>
• P for Compact PLUS, D for Compact devices	<b>P</b> <b>D</b>
• SIMOVERT MASTERDRIVES Motion Control	<b>5</b>
• SIMOVERT MASTERDRIVES Motion Control Performance 2	<b>7</b>
Power Cable Model	
• MOTION-CONNECT 800	<b>8</b>
• MOTION-CONNECT 500	<b>5</b>
• Without brake cable	<b>C</b>
• With brake cable	<b>D</b>

For information about length codes and signal cables, see "MOTION-CONNECT Connection System", Part 5.

1) If the absolute encoder is used,  $M_{\text{rated}}$  is reduced by 10%.  
 2) Same flange as IM B5, but with a metric helicoil in the four mounting holes.

3) The current carrying capacity of the power cables corresponds to IEC 60204-1 for Routing Type C under continuous duty conditions at an ambient air temperature of +40 °C (+104 °F), designed for  $I_0$  (100 K) PVC/PUR insulated cable.

# Servo Motors for SIMOVERT MASTERDRIVES

## Synchronous Servo Motors

### 1FT6 Motors Natural cooling

#### Selection and Ordering Data

Rated Rotational Speed	Shaft Height	Rated Output	Rated Torque <sup>1)</sup>	Rated Current	Standstill Torque	1FT6 Servo Motors Natural cooling	Pole Pair Number	Rotor Moment of Inertia (w/o Brake)	Weight (w/o Brake)
$n_{rated}$		$P_{rated}$ at $\Delta T=100$ K	$M_{rated}$ at $\Delta T=100$ K	$I_{rated}$ at $\Delta T=100$ K	$M_0$ at $\Delta T=100$ K	Order No. Standard Model		$J$	
rpm	SH	kW (HP)	Nm (lb <sub>f</sub> -in)	A	Nm (lb <sub>f</sub> -in)			10 <sup>-4</sup> kgm <sup>2</sup> (lb <sub>f</sub> -in-s <sup>2</sup> )	kg (lb)
4500	63	1.4 (1.88)	2.9 (25.7)	3.4	4 (35.4)	1FT6 061 – 6AH7 – ■■■■■■	3	6 (0.0053)	8 (17.6)
		1.7 (2.28)	3.6 (31.9)	3.9	6 (53.1)	1FT6 062 – 6AH7 – ■■■■■■	3	8.5 (0.0075)	9.5 (20.9)
		2.3 (3.08)	4.8 (42.5)	5.5	9.5 (84.1)	1FT6 064 – 6AH7 – ■■■■■■	3	13 (0.0115)	12.5 (27.6)
	80	2.7 (3.62)	5.8 (51.3)	7.3	8 (70.8)	1FT6 081 – 8AH7 – ■■■■■■	4	21 (0.0186)	12.5 (27.6)
		4 (5.36)	8.5 (75.2)	11	13 (115.1)	1FT6 082 – 8AH7 – ■■■■■■	4	30 (0.0266)	15 (33.1)
		4.9 (6.57)	10.5 (92.9)	12.5	20 (177)	1FT6 084 – 8AH7 – ■■■■■■	4	48 (0.0425)	20.5 (45.2)
		5.7 (7.64)	12 (106.2)	12.6	27 (239)	1FT6 086 – 8AH7 – ■■■■■■	4	66.5 (0.0589)	25.5 (56.2)
	100	5.7 (7.64)	12 (106.2)	12	27 (239)	1FT6 102 – 8AH7 – ■■■■■■	4	99 (0.0876)	27.5 (60.6)

• Construction type:	IM B5 IM B14 <sup>2)</sup>	1 2
• Connector outlet direction:	Transverse right (not for 1FT606) Transverse left (not for 1FT606) Axial non-drive end Axial drive end	1 2 3 4
• Terminal box, Cable entry (only for 1FT61..):	Transverse right Transverse left Axial non-drive end Axial drive end	5 6 7 8
• Encoder systems:	Incremental encoder sin/cos 1 V <sub>pp</sub> Absolute encoder EnDat, 2,048 pulses/revolution <sup>1)</sup> Resolver, multipole Resolver, 2-pole	A E S T
• Shaft end:	• Radial eccentricity tol.:	• Holding brake:
With key and keyway	N	No
With key and keyway	N	Yes
With key and keyway	R	No
With key and keyway	R	Yes
Keyless shaft	N	No
Keyless shaft	N	Yes
Keyless shaft	R	No
Keyless shaft	R	Yes
• Vibration severity grade:		• Degree of protection:
N		IP64
N		IP65
N		IP67
N		IP68
R		IP64
R		IP65
R		IP67
R		IP68
• Special models:		
Please specify option code; refer to page 2/9.		0 1 2 6 3 4 5 7 -Z

# Servo Motors for SIMOVERT MASTERDRIVES

## Synchronous Servo Motors

1FT6 Motors  
Natural cooling

2

### Selection and Ordering Data

Motor Type (continued)	Standstill Current  $I_0$ at $\Delta T=100\text{ K}$ A	SIMOVERT MASTERDRIVES MC Inverter/Converter Rated Current		Power Cable with Complete Shield Motor Connection with Brake Connection via Power Connector		
		$I_{\text{rated}}$ A	Order No. Inverter Converter	Power Connector Size	Cable Cross-section Motor <sup>3)</sup> mm <sup>2</sup>	Order No. Pre-Assembled Cable
1FT6 061 – 6AH7 . – ....	4	6.1 5	<b>6SE7 016 – 0 T P ■ 0</b> <b>6SE7 015 – 0 E P ■ 0</b>	1	4 x 1.5	<b>6FX ■ 002 – 5 ■ A01 – ... 0</b>
1FT6 062 – 6AH7 . – ....	5.7	6.1 8	<b>6SE7 016 – 0 T P ■ 0</b> <b>6SE7 018 – 0 E P ■ 0</b>	1	4 x 1.5	<b>6FX ■ 002 – 5 ■ A01 – ... 0</b>
1FT6 064 – 6AH7 . – ....	9	10.2 10	<b>6SE7 021 – 0 T P ■ 0</b> <b>6SE7 021 – 0 E P ■ 0</b>	1	4 x 1.5	<b>6FX ■ 002 – 5 ■ A01 – ... 0</b>
1FT6 081 – 8AH7 . – ....	8.6	10.2 10	<b>6SE7 021 – 0 T P ■ 0</b> <b>6SE7 021 – 0 E P ■ 0</b>	1.5	4 x 1.5	<b>6FX ■ 002 – 5 ■ A21 – ... 0</b>
1FT6 082 – 8AH7 . – ....	14.8	17.5 20.5	<b>6SE7 021 – 8 T P ■ 0</b> <b>6SE7 022 – 1 E P ■ 0</b>	1.5	4 x 1.5	<b>6FX ■ 002 – 5 ■ A21 – ... 0</b>
1FT6 084 – 8AH7 . – ....	19.8	25.5 20.5	<b>6SE7 022 – 6 T P ■ 0</b> <b>6SE7 022 – 1 E P ■ 0</b>	1.5	4 x 4	<b>6FX ■ 002 – 5 ■ A41 – ... 0</b>
1FT6 086 – 8AH7 . – ....	23.3	25.5 27	<b>6SE7 022 – 6 T P ■ 0</b> <b>6SE7 022 – 7 E P ■ 0</b>	1.5	4 x 4	<b>6FX ■ 002 – 5 ■ A41 – ... 0</b>
1FT6 102 – 8AH7 . – ....	24.1	25.5 27	<b>6SE7 022 – 6 T P ■ 1</b> <b>6SE7 022 – 7 E P ■ 1</b>	1.5	4 x 4	<b>6FX ■ 002 – 5 ■ A41 – ... 0</b>

• Converter • Inverter	<b>E</b> <b>T</b>	
• Compact PLUS	<b>P</b>	
• SIMOVERT MASTERDRIVES Motion Control • SIMOVERT MASTERDRIVES Motion Control Performance 2	<b>5</b> <b>7</b>	
Power Cable Model • MOTION-CONNECT 800 • MOTION-CONNECT 500		<b>8</b> <b>5</b>
• Without brake cable • With brake cable		<b>C</b> <b>D</b>

For information about length codes and signal cables, see "MOTION-CONNECT Connection System", Part 5.

1) If the absolute encoder is used,  $M_{\text{rated}}$  is reduced by 10%.  
2) Same flange as IM B5, but with a metric helicoil in the four mounting holes.

3) The current carrying capacity of the power cables corresponds to IEC 60204-1 for Routing Type C under continuous duty conditions at an ambient air temperature of +40 °C (+104 °F), designed for  $I_0$  (100 K) PVC/PUR insulated cable.

# Servo Motors for SIMOVERT MASTERDRIVES

## Synchronous Servo Motors

### 1FT6 Motors Natural cooling

#### Selection and Ordering Data

Rated Rotational Speed	Shaft Height	Rated Output	Rated Torque <sup>1)</sup>	Rated Current	Standstill Torque	1FT6 Servo Motors Natural cooling	Pole Pair Number	Rotor Moment of Inertia (w/o Brake)	Weight (w/o Brake)
$n_{rated}$		$P_{rated}$ at $\Delta T=100$ K	$M_{rated}$ at $\Delta T=100$ K	$I_{rated}$ at $\Delta T=100$ K	$M_0$ at $\Delta T=100$ K	Order No. Standard Model		$J$	
rpm	SH	kW (HP)	Nm (lb <sub>f</sub> -in)	A	Nm (lb <sub>f</sub> -in)			10 <sup>-4</sup> kgm <sup>2</sup> (lb <sub>f</sub> -in-s <sup>2</sup> )	kg (lb)
6000	28	0.19 (0.25)	0.3 (2.7)	1.1	0.4 (3.5)	1FT6 021 – 6AK7 1 – ■■■■■	3	0.21 (0.0002)	1.2 (2.6)
		0.31 (0.42)	0.5 (4.4)	0.9	0.8 (7.1)	1FT6 024 – 6AK7 1 – ■■■■■	3	0.34 (0.0003)	2.1 (4.6)
	36	0.47 (0.63)	0.75 (6.6)	1.2	1 (8.8)	1FT6 031 – 4AK7 1 – ■■■■■	2	0.65 (0.0006)	3.1 (6.8)
		0.88 (1.18)	1.4 (12.4)	2.1	2 (17.7)	1FT6 034 – 4AK7 1 – ■■■■■	2	1.1 (0.0010)	4.4 (9.7)
	48	1.1 (1.47)	1.7 (15)	2.4	2.6 (23)	1FT6 041 – 4AK7 1 – ■■■■■	2	2.9 (0.0025)	6.6 (14.6)
		1.9 (2.55)	3 (26.6)	4.1	5 (44.3)	1FT6 044 – 4AK7 1 – ■■■■■	2	5.1 (0.0045)	8.3 (18.3)
	63	1.3 (1.74)	2.1 (18.6)	3.1	4 (35.4)	1FT6 061 – 6AK7 ■ – ■■■■■	3	6 (0.0053)	8 (17.6)
		1.3 (1.74)	2.1 (18.6)	3.2	6 (53.1)	1FT6 062 – 6AK7 ■ – ■■■■■	3	8.5 (0.0075)	9.5 (20.9)
		1.3 (1.74)	2.1 (18.6)	3.5	9.5 (84.1)	1FT6 064 – 6AK7 ■ – ■■■■■	3	13 (0.0115)	12.5 (27.6)
	80	2.9 (3.89)	4.6 (40.7)	7.7	8 (70.8)	1FT6 081 – 8AK7 ■ – ■■■■■	4	21 (0.0186)	12.5 (27.6)
		3.5 (4.69)	5.5 (48.7)	9.1	13 (115.1)	1FT6 082 – 8AK7 ■ – ■■■■■	4	30 (0.0266)	15 (33.1)
		4.1 (5.55)	6.5 (57.5)	9.2	20 (177)	1FT6 084 – 8AK7 ■ – ■■■■■	4	48 (0.0425)	20.5 (45.2)

• Construction type:	IM B5 IM B14 <sup>2)</sup> (not for 1FT602, 1FT603, 1FT604)	1 2
• Connector outlet direction:	Transverse right (not for 1FT603, 1FT604, 1FT606) Transverse left (not for 1FT603, 1FT604, 1FT606) Axial non-drive end Axial drive end	1 2 3 4
• Encoder systems:	Incremental encoder sin/cos 1 V <sub>pp</sub> Absolute encoder EnDat 2,048 pulses/rev <sup>1) 3)</sup> Absolute encoder EnDat 512 pulses/rev <sup>1) 4)</sup> Multipole resolver 2-pole resolver	A E H S T
• Shaft end:	• Radial eccentricity tol.:	• Holding brake:
With key and keyway	N	No
With key and keyway	N	Yes
With key and keyway	R	No
With key and keyway	R	Yes
Keyless shaft	N	No
Keyless shaft	N	Yes
Keyless shaft	R	No
Keyless shaft	R	Yes
• Vibration severity grade:		• Degree of protection:
N		IP64
N <sup>3)</sup>		IP65 <sup>3)</sup>
N		IP67
N <sup>3)</sup>		IP68 <sup>3)</sup>
R		IP64
R <sup>3)</sup>		IP65 <sup>3)</sup>
R		IP67
R <sup>3)</sup>		IP68 <sup>3)</sup>
• Special models:		0 1 2 6 3 4 5 7
Please specify option code; refer to page 2/9.		-Z

# Servo Motors for SIMOVERT MASTERDRIVES

## Synchronous Servo Motors

1FT6 Motors  
Natural cooling

2

### Selection and Ordering Data

Motor Type (continued)	Standstill Current  $I_0$ at $\Delta T=100\text{ K}$ A	SIMOVERT MASTERDRIVES MC Inverter/Converter Rated Current		Power Cable with Complete Shield Motor Connection with Brake Connection via Power Connector		
		$I_{\text{rated}}$ A	Order No. Inverter Converter	Power Connector Size	Cable Cross-section Motor <sup>5)</sup> mm <sup>2</sup>	Order No. Pre-Assembled Cable
1FT6 021 – 6AK71 – ....	1.25	2 1.5	<b>6SE7 012 – 0 T P ■ 0</b> <b>6SE7 011 – 5 E P ■ 0</b>	1	4 x 1.5	<b>6FX ■ 002 – 5 ■ A01 – ... 0</b>
1FT6 024 – 6AK71 – ....	1.25	2 1.5	<b>6SE7 012 – 0 T P ■ 0</b> <b>6SE7 011 – 5 E P ■ 0</b>	1	4 x 1.5	<b>6FX ■ 002 – 5 ■ A01 – ... 0</b>
1FT6 031 – 4AK71 – ....	1.4	2 1.5	<b>6SE7 012 – 0 T P ■ 0</b> <b>6SE7 011 – 5 E P ■ 0</b>	1	4 x 1.5	<b>6FX ■ 002 – 5 ■ A01 – ... 0</b>
1FT6 034 – 4AK71 – ....	2.6	4 3	<b>6SE7 014 – 0 T P ■ 0</b> <b>6SE7 013 – 0 E P ■ 0</b>	1	4 x 1.5	<b>6FX ■ 002 – 5 ■ A01 – ... 0</b>
1FT6 041 – 4AK71 – ....	3	4 3	<b>6SE7 014 – 0 T P ■ 0</b> <b>6SE7 013 – 0 E P ■ 0</b>	1	4 x 1.5	<b>6FX ■ 002 – 5 ■ A01 – ... 0</b>
1FT6 044 – 4AK71 – ....	5.9	6.1 8	<b>6SE7 016 – 0 T P ■ 0</b> <b>6SE7 018 – 0 E P ■ 0</b>	1	4 x 1.5	<b>6FX ■ 002 – 5 ■ A01 – ... 0</b>
1FT6 061 – 6AK7 . – ....	5	6.1 5	<b>6SE7 016 – 0 T P ■ 0</b> <b>6SE7 015 – 0 E P ■ 0</b>	1	4 x 1.5	<b>6FX ■ 002 – 5 ■ A01 – ... 0</b>
1FT6 062 – 6AK7 . – ....	7.6	10.2 8	<b>6SE7 021 – 0 T P ■ 0</b> <b>6SE7 018 – 0 E P ■ 0</b>	1	4 x 1.5	<b>6FX ■ 002 – 5 ■ A01 – ... 0</b>
1FT6 064 – 6AK7 . – ....	12	13.2 14	<b>6SE7 021 – 3 T P ■ 0</b> <b>6SE7 021 – 4 E P ■ 0</b>	1	4 x 1.5	<b>6FX ■ 002 – 5 ■ A01 – ... 0</b>
1FT6 081 – 8AK7 . – ....	11.1	13.2 14	<b>6SE7 021 – 3 T P ■ 1</b> <b>6SE7 021 – 4 E P ■ 1</b>	1.5	4 x 1.5	<b>6FX ■ 002 – 5 ■ A21 – ... 0</b>
1FT6 082 – 8AK7 . – ....	17.3	17.5 20.5	<b>6SE7 021 – 8 T P ■ 0</b> <b>6SE7 022 – 1 E P ■ 0</b>	1.5	4 x 2.5	<b>6FX ■ 002 – 5 ■ A31 – ... 0</b>
1FT6 084 – 8AK7 . – ....	24.1	25.5 27	<b>6SE7 022 – 6 T P ■ 0</b> <b>6SE7 022 – 7 E P ■ 0</b>	1.5	4 x 4	<b>6FX ■ 002 – 5 ■ A41 – ... 0</b>

• Converter	<b>E</b>
• Inverter	<b>T</b>
• Compact PLUS	<b>P</b>
• SIMOVERT MASTERDRIVES Motion Control	<b>5</b>
• SIMOVERT MASTERDRIVES Motion Control Performance 2	<b>7</b>
Power Cable Model	
• MOTION-CONNECT 800	<b>8</b>
• MOTION-CONNECT 500	<b>5</b>
• Without brake cable	<b>C</b>
• With brake cable	<b>D</b>

For information about length codes and signal cables, see "MOTION-CONNECT Connection System", Part 5.

1) If the absolute encoder is used,  $M_{\text{rated}}$  is reduced by 10%.  
 2) Same flange as IM B5, but with a metric helicoil in the four mounting holes.  
 3) Not available for 1FT602

4) Only available for 1FT602  
 5) The current carrying capacity of the power cables corresponds to IEC 60204-1 for Routing Type C under continuous duty conditions at an ambient air temperature of +40 °C (+104 °F), designed for  $I_0$  (100 K) PVC/PUR insulated cable.



# Servo Motors for SIMOVERT MASTERDRIVES

## Synchronous Servo Motors

### 1FT6 Motors Forced ventilation

#### Selection and Ordering Data

Rated Rotational Speed	Shaft Height	Rated Output	Rated Torque <sup>1)</sup>	Rated Current	Standstill Torque	1FT6 Servo Motors Forced ventilation <sup>2)</sup>	Pole Pair Number	Rotor Moment of Inertia (w/o Brake)	Weight (w/o Brake)
$n_{rated}$		$P_{rated}$ at $\Delta T=100$ K	$M_{rated}$ at $\Delta T=100$ K	$I_{rated}$ at $\Delta T=100$ K	$M_0$ at $\Delta T=100$ K	Order No.		$J$	
rpm	SH	kW (HP)	Nm (lb <sub>f</sub> -in)	A	Nm (lb <sub>f</sub> -in)			10 <sup>-4</sup> kgm <sup>2</sup> (lb <sub>f</sub> -in-s <sup>2</sup> )	kg (lb)
1500	100	9.3 (12.47)	59 (522.2)	21.7	65 (575.3)	1FT6 105 – 8SB7 – ■■■■■■	4	168 (0.1487)	45.5 (100.3)
		13 (17.43)	83 (734.6)	31	90 (796.6)	1FT6 108 – 8SB7 – ■■■■■■	4	260 (0.2301)	61.5 (135.6)
	132	16 (21.45)	102 (902.8)	36	110 (973.6)	1FT6 132 – 6SB7 1 – ■■■■■■	3	430 (0.3806)	91 (200.6)
		20.4 (27.35)	130 (1150.6)	45	140 (1239.1)	1FT6 134 – 6SB7 1 – ■■■■■■	3	547 (0.4810)	106 (233.7)
		25.1 (33.65)	160 (1416.2)	55	175 (1548.9)	1FT6 136 – 6SB7 1 – ■■■■■■	3	664 (0.5876)	123 (271.2)
2000	100	11.7 (15.68)	56 (495.6)	28	65 (575.3)	1FT6 105 – 8SC7 – ■■■■■■	4	168 (0.1487)	45.5 (100.3)
		16.8 (22.52)	80 (708.1)	40	90 (796.6)	1FT6 108 – 8SC7 – ■■■■■■	4	260 (0.2301)	61.5 (135.6)
	132	20.5 (27.48)	98 (867.4)	46	110 (973.6)	1FT6 132 – 6SC7 – ■■■■■■	3	430 (0.3806)	91 (200.6)
		26.2 (35.12)	125 (1106.4)	57	140 (1239.1)	1FT6 134 – 6SC7 – ■■■■■■	3	547 (0.4810)	106 (233.7)
		32.5 (43.56)	155 (1371.9)	72	175 (1548.9)	1FT6 136 – 6SC7 – ■■■■■■	3	664 (0.5876)	123 (271.2)

• Construction type:	IM B5 IM B14 <sup>3)</sup> (not for 1FT613)	1 2
• Connector outlet direction (except for 1FT6 136–6SF71):	Transverse right Transverse left Axial non-drive end (not for 1FT613) Axial drive end	1 2 3 4
• Terminal box, Cable entry (only for 1FT61..):	Transverse right Transverse left Axial non-drive end Axial drive end	5 6 7 8
• Encoder systems:	Incremental encoder sin/cos 1 V <sub>pp</sub> Absolute encoder EnDat, 2,048 pulses/revolution <sup>1)</sup> Resolver, multipole Resolver, 2-pole	A E S T
• Shaft end:	• Radial eccentricity tol.:	• Holding brake:
With key and keyway	N	No
With key and keyway	N	Yes
With key and keyway	R	No
With key and keyway	R	Yes
Keyless shaft	N	No
Keyless shaft	N	Yes
Keyless shaft	R	No
Keyless shaft	R	Yes
• Vibration severity grade:		• Degree of protection: <sup>4)</sup>
N		IP64
N		IP65
R		IP64
R		IP65
• Special models:		
Please specify option code; refer to page 2/9.		0 1 3 4 –Z

# Servo Motors for SIMOVERT MASTERDRIVES

## Synchronous Servo Motors

1FT6 Motors  
Forced ventilation

2

### Selection and Ordering Data

Motor Type (continued)	Standstill Current  $I_0$ at $\Delta T=100\text{ K}$  A	SIMOVERT MASTERDRIVES MC Inverter/Converter Rated Current		Power Cable with Complete Shield Motor Connection with Brake Connection via Power Connector		
		$I_{rated}$  A	Order No. Inverter Converter	Power Connector  Size	Motor Cable Cross-Section <sup>5)</sup>  mm <sup>2</sup>	Order No. Pre-Assembled Cable
1FT6 105 – 8SB7 . – ....	21.9	25.5 27	<b>6SE7 022 – 6 T P ■ 0</b> <b>6SE7 022 – 7 E P ■ 0</b>	1.5	4 x 4	<b>6FX ■ 002 – 5 ■ A41 – ... 0</b>
1FT6 108 – 8SB7 . – ....	30	34	<b>6SE7 023 – 4 ■ P ■ 0</b>	1.5	4 x 6	<b>6FX ■ 002 – 5 ■ A51 – ... 0</b>
1FT6 132 – 6SB71 – ....	36	37.5	<b>6SE7 023 – 8 ■ D ■ 1</b>	3	4 x 10	<b>6FX ■ 002 – 5 ■ A13 – ... 0</b>
1FT6 134 – 6SB71 – ....	44	47	<b>6SE7 024 – 7 ■ D ■ 1</b>	3	4 x 10	<b>6FX ■ 002 – 5 ■ A13 – ... 0</b>
1FT6 136 – 6SB71 – ....	55	59	<b>6SE7 026 – 0 ■ D ■ 1</b>	3	4 x 16	<b>6FX ■ 002 – 5 ■ A23 – ... 0</b>
1FT6 105 – 8SC7 . – ....	30	34	<b>6SE7 023 – 4 ■ P ■ 0</b>	1.5	4 x 6	<b>6FX ■ 002 – 5 ■ A51 – ... 0</b>
1FT6 108 – 8SC7 . – ....	41	47	<b>6SE7 024 – 7 ■ D ■ 1</b>	3	4 x 10	<b>6FX ■ 002 – 5 ■ A13 – ... 0</b>
1FT6 132 – 6SC7 . – ....	47	47	<b>6SE7 024 – 7 ■ D ■ 1</b>	3	4 x 16	<b>6FX ■ 002 – 5 ■ A23 – ... 0</b>
1FT6 134 – 6SC7 . – ....	58	59	<b>6SE7 026 – 0 ■ D ■ 1</b>	3	4 x 16	<b>6FX ■ 002 – 5 ■ A23 – ... 0</b>
1FT6 136 – 6SC7 . – ....	77	92	<b>6SE7 031 – 0 ■ E ■ 0</b>	3	4 x 25	<b>6FX ■ 002 – 5 D A33 – ... 0</b>

<ul style="list-style-type: none"> <li>• Converter</li> <li>• Inverter</li> </ul>	<b>E</b> <b>T</b>
<ul style="list-style-type: none"> <li>• <b>P</b> for Compact PLUS, <b>D</b> for Compact devices, <b>E</b> for chassis devices</li> </ul>	<b>P</b> <b>D</b> <b>E</b>
<ul style="list-style-type: none"> <li>• SIMOVERT MASTERDRIVES Motion Control</li> <li>• SIMOVERT MASTERDRIVES Motion Control Performance 2</li> </ul>	<b>5</b> <b>7</b>
Power Cable Model <ul style="list-style-type: none"> <li>• MOTION-CONNECT 800</li> <li>• MOTION-CONNECT 500</li> </ul>	<b>8</b> <b>5</b>
<ul style="list-style-type: none"> <li>• Without brake cable</li> <li>• With brake cable</li> </ul>	<b>C</b> <b>D</b>

For information about length codes and signal cables, see "MOTION-CONNECT Connection System", Part 5.

Note on forced ventilation:

	Shaft heights 80 and 100	Shaft height 132
Direction of air flow	From NDE to DE	From DE to NDE
Cables and connections	Connector size 1	Terminal box
Type of cable to be connected	6FX. 002-5CA01-...0	6FX. 008-1BB11-...A0
Pin and terminal assignments	Pin 1: L1, Pin 2: N	U1/L1; V2/L2; W3/L3
Supply voltage	1-phase AC 220/260 V, 50/60 Hz	3-phase AC 400/480 V, 50/60 Hz
Max. fan current	0.3 A	0.4 A
Sound pressure level	Shaft height 80: 69 dB (A) Shaft height 100: 71 dB (A)	74 dB (A)

- 1) If the absolute encoder is used,  $M_{rated}$  is reduced by 10%.
- 2) Forced ventilation cannot be used in the presence of flammable, corrosive, electrically conductive, or explosive dust.
- 3) Same flange as IM B5, but with a metric helicoil in the four mounting holes.

- 4) This degree of protection refers to the motor; the built-on fan satisfies degree of protection IP54.
- 5) The current carrying capacity of the power cables corresponds to IEC 60204-1 for Routing Type C under continuous duty conditions at an ambient air temperature of +40 °C (+104 °F), designed for  $I_0$  (100 K) PVC/PUR insulated cable.

# Servo Motors for SIMOVERT MASTERDRIVES

## Synchronous Servo Motors

### 1FT6 Motors Forced ventilation

#### Selection and Ordering Data

Rated Rotational Speed	Shaft Height	Rated Output	Rated Torque <sup>1)</sup>	Rated Current	Standstill Torque	1FT6 Servo Motors Forced ventilation <sup>2)</sup>	Pole Pair Number	Rotor Moment of Inertia (w/o Brake)	Weight (w/o Brake)
$n_{rated}$		$P_{rated}$ at $\Delta T=100$ K	$M_{rated}$ at $\Delta T=100$ K	$I_{rated}$ at $\Delta T=100$ K	$M_0$ at $\Delta T=100$ K	Order No.		$J$	
rpm	SH	kW (HP)	Nm (lb <sub>f</sub> -in)	A	Nm (lb <sub>f</sub> -in)			10 <sup>-4</sup> kgm <sup>2</sup> (lb <sub>f</sub> -in-s <sup>2</sup> )	kg (lb)
3000	80	6.9 (9.25)	22 (194.7)	17	26 (230.1)	1FT6 084 – 8SF7 – ■■■■■■	4	48 (0.0425)	25 (55.1)
		9.7 (13)	31 (274.4)	24.5	35 (309.8)	1FT6 086 – 8SF7 – ■■■■■■	4	66.5 (0.0589)	30 (66.2)
	100	15.7 (21.05)	50 (442.6)	35	65 (575.3)	1FT6 105 – 8SF7 – ■■■■■■	4	168 (0.1487)	45.5 (100.3)
		22 (29.49)	70 (619.6)	53	90 (796.6)	1FT6 108 – 8SF7 – ■■■■■■	4	260 (0.2301)	61.5 (135.6)
	132	28.3 (37.94)	90 (796.6)	62	110 (973.6)	1FT6 132 – 6SF7 1 – ■■■■■■	3	430 (0.3806)	91 (200.6)
			110 (973.6)	72	140 (1239.1)	1FT6 134 – 6SF7 1 – ■■■■■■	3	547 (0.4810)	106 (233.7)
45.5 (60.99)		145 (1283.4)	104	175 (1548.9)	1FT6 136 – 6SF7 1 – ■■■■■■	3	664 (0.5876)	123 (271.2)	
4500	80	9.4 (12.6)	20 (177)	24.5	26 (230.1)	1FT6 084 – 8SH7 – ■■■■■■	4	48 (0.0425)	25 (55.1)
		12.7 (17.02)	27 (239)	31.5	35 (309.8)	1FT6 086 – 8SH7 – ■■■■■■	4	66.5 (0.0589)	30 (66.2)
	100	18.8 (25.2)	40 (354)	41	65 (575.3)	1FT6 105 – 8SH7 – ■■■■■■	4	168 (0.1487)	45.5 (100.3)
6000	80	10.7 (14.34)	17 (150.5)	25.5	26 (230.1)	1FT6 084 – 8SK7 – ■■■■■■	4	48 (0.0425)	25 (55.1)
		13.8 (18.5)	22 (194.7)	29	35 (309.8)	1FT6 086 – 8SK7 – ■■■■■■	4	66.5 (0.0589)	30 (66.2)

• Construction type:	IM B5 IM B14 <sup>3)</sup> (not for 1FT613)	1 2
• Connector outlet direction (except for 1FT6 136–6SF71):	Transverse right Transverse left Axial non-drive end (not for 1FT613) Axial drive end	1 2 3 4
• Terminal box, Cable entry (only for 1FT61..):	Transverse right Transverse left Axial non-drive end Axial drive end	5 6 7 8
• Encoder systems:	Incremental encoder sin/cos 1 V <sub>pp</sub> Absolute encoder EnDat, 2,048 pulses/revolution <sup>1)</sup> Resolver, multipole Resolver, 2-pole	A E S T
• Shaft end: With key and keyway With key and keyway With key and keyway With key and keyway Keyless shaft Keyless shaft Keyless shaft Keyless shaft	• Radial eccentricity tol.: N N R R N N R R	A B D E G H K L
• Holding brake:	No Yes No Yes No Yes No Yes	
• Vibration severity grade: N N R R	• Degree of protection: <sup>4)</sup> IP64 IP65 IP64 IP65	0 1 3 4
• Special models: Please specify option code; refer to page 2/9.		–Z

# Servo Motors for SIMOVERT MASTERDRIVES

## Synchronous Servo Motors

1FT6 Motors  
Forced ventilation

2

### Selection and Ordering Data

Motor Type (continued)	Standstill Current  $I_0$ at $\Delta T=100$ K  A	SIMOVERT MASTERDRIVES MC Inverter/Converter Rated Current		Power Cable with Complete Shield Motor Connection with Brake Connection via Power Connector		
		$I_{rated}$ A	Order No. Inverter Converter	Power Connector  Size	Motor Cable Cross-Section <sup>5)</sup>  mm <sup>2</sup>	Order No. Pre-Assembled Cable
1FT6 084 – 8SF7 . – ....	18.2	25.5 20.5	<b>6SE7 022 – 6 T P ■ 0</b> <b>6SE7 022 – 1 E P ■ 0</b>	1.5	4 x 2.5	<b>6FX ■ 002 – 5 ■ A31 – ... 0</b>
1FT6 086 – 8SF7 . – ....	25	34	<b>6SE7 023 – 4 P ■ 0</b>	1.5	4 x 4	<b>6FX ■ 002 – 5 ■ A41 – ... 0</b>
1FT6 105 – 8SF7 . – ....	42	47	<b>6SE7 024 – 7 D ■ 1</b>	3	4 x 10	<b>6FX ■ 002 – 5 ■ A13 – ... 0</b>
1FT6 108 – 8SF7 . – ....	62	72	<b>6SE7 027 – 2 D ■ 1</b>	3	4 x 16	<b>6FX ■ 002 – 5 ■ A23 – ... 0</b>
1FT6 132 – 6SF71 – ....	69	72	<b>6SE7 027 – 2 D ■ 1</b>	3	4 x 25	<b>6FX ■ 002 – 5 D A33 – ... 0</b>
1FT6 134 – 6SF71 – ....	83	92	<b>6SE7 031 – 0 E ■ 0</b>	3	4 x 25	<b>6FX ■ 002 – 5 D A33 – ... 0</b>
1FT6 136 – 6SF71 – ....	110	124	<b>6SE7 031 – 2 F ■ 0</b>	Terminal box PG 36	Max. connectable 4 x 35 mm <sup>2</sup>	Cable by the meter See Part 5
1FT6 084 – 8SH7 . – ....	26	34	<b>6SE7 023 – 4 P ■ 0</b>	1.5	4 x 4	<b>6FX ■ 002 – 5 ■ A41 – ... 0</b>
1FT6 086 – 8SH7 . – ....	38	47	<b>6SE7 024 – 7 D ■ 1</b>	3	4 x 10	<b>6FX ■ 002 – 5 ■ A13 – ... 0</b>
1FT6 105 – 8SH7 . – ....	59	59	<b>6SE7 026 – 0 D ■ 1</b>	3	4 x 16	<b>6FX ■ 002 – 5 ■ A23 – ... 0</b>
1FT6 084 – 8SK7 . – ....	35	37.5	<b>6SE7 023 – 8 D ■ 1</b>	1.5	4 x 6	<b>6FX ■ 002 – 5 ■ A51 – ... 0</b>
1FT6 086 – 8SK7 . – ....	44	47	<b>6SE7 024 – 7 D ■ 1</b>	3	4 x 10	<b>6FX ■ 002 – 5 ■ A13 – ... 0</b>

- Converter
- Inverter

E  
T

- **P** for Compact PLUS, **D** for Compact devices,  
**E** and **F** for chassis devices

P  
D  
E  
F

- SIMOVERT MASTERDRIVES Motion Control
- SIMOVERT MASTERDRIVES Motion Control Performance 2

5  
7

#### Power Cable Model

- MOTION-CONNECT 800
- MOTION-CONNECT 500

8  
5

- Without brake cable
- With brake cable

C  
D

For information about length codes and signal cables, see "MOTION-CONNECT Connection System", Part 5.

Note on forced ventilation:

	Shaft heights 80 and 100	Shaft height 132
Direction of air flow	From NDE to DE	From DE to NDE
Cables and connections	Connector size 1	Terminal box
Type of cable to be connected	6FX. 002-5CA01-...0	6FX. 008-1BB11-...A0
Pin and terminal assignments	Pin 1: L1, Pin 2: N	U1/L1; V2/L2; W3/L3
Supply voltage	1-phase AC 220/260 V, 50/60 Hz	3-phase AC 400/480 V, 50/60 Hz
Max. fan current	0.3 A	0.4 A
Sound pressure level	Shaft height 80: 69 dB (A) Shaft height 100: 71 dB (A)	74 dB (A)

# Servo Motors for SIMOVERT MASTERDRIVES

## Synchronous Servo Motors

### 1FT6 Big Servo Motors Forced ventilation

#### Selection and Ordering Data

Rated Rotational Speed	Shaft Height	Rated Output	Rated Torque	Rated Current	Standstill Torque	1FT6 Big Servo Synchronous Motors Forced ventilation <sup>1)</sup>	Pole Pair Number	Rotor Moment of Inertia (w/o Brake)	Weight (w/o Brake)
$n_{rated}$		$P_{rated}$ at $\Delta T=100\text{ K}$	$M_{rated}$ at $\Delta T=100\text{ K}$	$I_{rated}$ at $\Delta T=100\text{ K}$	$M_0$ at $\Delta T=100\text{ K}$	Order No.		$J$	
rpm	SH	kW (HP)	Nm (lb <sub>f</sub> -in)	A	Nm (lb <sub>f</sub> -in)			10 <sup>-4</sup> kgm <sup>2</sup> (lb <sub>f</sub> -in-s <sup>2</sup> )	kg (lb)
1500	160	60.5 (81.1)	385 (3407.6)	136	425 (3761.7)	1FT6 163 – 8SB7 6 – ■■■■	4	2300 (2.0355)	170 (374.9)
		85 <sup>2)</sup> (113.94) <sup>2)</sup>	540 <sup>2)</sup> (4779.6) <sup>2)</sup>	174 <sup>2)</sup>	600 (5310.6)	1FT6 168 – 8SB7 6 – ■■■■	4	3100 (2.7435)	210 (463.1)
2500	160	89 <sup>2)</sup> (119.3) <sup>2)</sup>	340 <sup>2)</sup> (3009.3) <sup>2)</sup>	185 <sup>2)</sup>	425 (3761.7)	1FT6 163 – 8SD7 6 – ■■■■	4	2300 (2.0355)	170 (374.9)

• Construction type:	IM B35	6
• Terminal box on top, Cable entry:	Transverse right Transverse left Axial non-drive end Axial drive end	5 6 7 8
• Encoder systems:	Incremental encoder sin/cos 1 V <sub>pp</sub> Absolute encoder EnDat, 2,048 pulses/revolution Resolver, multipole Resolver, 2-pole	A E S T
• Shaft end: With key and keyway With key and keyway Keyless shaft Keyless shaft	• Radial eccentricity tol.: N N R R	• Holding brake: No No No No
• Vibration severity grade: N N R R	• Degree of protection: <sup>3)</sup> IP64 IP65 IP64 IP65	0 1 3 4
• Special models: Please specify option code; refer to page 2/9.		-Z

1) Forced ventilation cannot be used in the presence of flammable, corrosive, electrically conductive, or explosive dust.

2) Rating only valid for Masterdrives MC with infeed AFE.

3) This degree of protection refers to the motor; the built-on fan satisfies degree of protection IP54.

# Servo Motors for SIMOVERT MASTERDRIVES

## Synchronous Servo Motors

1FT6 Big Servo Motors  
Forced ventilation

2

### Selection and Ordering Data

Motor Type (continued)	Standstill Current  $I_0$ at $\Delta T=100\text{ K}$ A	SIMOVERT MASTERDRIVES MC Inverter/Converter Rated Current		Power Cable with Complete Shield Motor connection via terminal box		
		$I_{\text{rated}}$ A	Order No.	Terminal Box Type Cable Entry	Max. Connectable Cable Cross-Section mm <sup>2</sup>	Order No. Pre-Assembled Cable/ By the Meter
1FT6 163 – 8SB76 – ....	151	155	<b>6SE7 031 – 8 F 0</b>	gk 630 2 x M50 x 1.5	2 x 4 x 50	<b>6FX 008 –1BB50 –... 0</b>
1FT6 168 – 8SB76 – ....	194	218	<b>6SE7 032 – 6 G 0</b>	gk 630 2 x M50 x 1.5	2 x 4 x 50	<b>6FX 008 –1BB50 –... 0</b>
1FT6 163 – 8SD76 – ....	226	262	<b>6SE7 033 – 2 G 0</b>	gk 630 2 x M50 x 1.5	2 x 4 x 50	<b>6FX 008 –1BB50 –... 0</b>
<ul style="list-style-type: none"> <li>• Converter</li> <li>• Inverter</li> </ul>				<b>E</b>	<b>T</b>	
<ul style="list-style-type: none"> <li>• <b>F</b> and <b>G</b> for chassis devices</li> </ul>				<b>F</b>	<b>G</b>	
<ul style="list-style-type: none"> <li>• SIMOVERT MASTERDRIVES Motion Control</li> <li>• SIMOVERT MASTERDRIVES Motion Control Performance 2</li> </ul>				<b>5</b>	<b>7</b>	
Power Cable Model						
<ul style="list-style-type: none"> <li>• MOTION-CONNECT 800</li> <li>• MOTION-CONNECT 500</li> </ul>						<b>8</b> <b>5</b>

For information about length codes and signal cables, see "MOTION-CONNECT Connection System", Part 5.

Note on forced ventilation:

	Shaft height 160
Direction of air flow	From DE to NDE
Cables and connections	Terminal box
Type of cable to be connected	6FX...A0
Pin and terminal assignments	U1/L1; V2/L2; W3/L3
Supply voltage	3-phase AC 400/480 V, 50/60 Hz
Max. fan current	0.8 A
Sound pressure level	74 dB (A)



# Servo Motors for SIMOVERT MASTERDRIVES

## Synchronous Servo Motors

### 1FT6 Motors Water Cooling

#### Selection and Ordering Data

Rated Rotational Speed	Shaft Height	Rated Output	Rated Torque <sup>1)</sup>	Rated Current	Standstill Torque	1FT6 Servo Motors <sup>5)</sup> Water Cooling	Pole Pair Number	Rotor Moment of Inertia (w/o Brake)	Weight (w/o Brake)
$n_{rated}$		$P_{rated}$ at $\Delta T=100$ K	$M_{rated}$ at $\Delta T=100$ K	$I_{rated}$ at $\Delta T=100$ K	$M_0$ at $\Delta T=100$ K	Order No.		$J$	
rpm	SH	kW (HP)	Nm (lb <sub>f</sub> -in)	A	Nm (lb <sub>f</sub> -in)			10 <sup>-4</sup> kgm <sup>2</sup> (lb <sub>f</sub> -in-s <sup>2</sup> )	kg (lb)
1500	100	18.2 (24.4)	116 (1026.7)	43	119 (1053.3)	1FT6 108 – 8WB7 ■ – ■ ■ ■ ■	4	260 (0.2301)	61.5 (135.6)
2000	100	17.2 (23.06)	82 (725.8)	60	85 (752.3)	1FT6 105 – 8WC7 ■ – ■ ■ ■ ■	4	168 (0.1487)	45.5 (100.3)
		24.1 (32.31)	115 (1018)	57	119 (1053.3)	1FT6 108 – 8WC7 ■ – ■ ■ ■ ■	4	260 (0.2301)	61.5 (135.6)
3000	63	3.2 (4.29)	10 (88.5)	6.9	10.2 (90.3)	1FT6 062 – 6WF7 ■ – ■ ■ ■ ■	3	8.5 (0.0075)	9.5 (20.9)
		5.1 (6.84)	16 (141.6)	10.3	16.2 (143.4)	1FT6 064 – 6WF7 ■ – ■ ■ ■ ■	3	13 (0.0115)	12.5 (27.6)
	80	11.0 (14.75)	35 (309.8)	27	35 (309.8)	1FT6 084 – 8WF7 ■ – ■ ■ ■ ■	4	48 (0.0425)	21 (46.3)
		14.5 (19.44)	46 (407.1)	37	47 (416)	1FT6 086 – 8WF7 ■ – ■ ■ ■ ■	4	66.5 (0.0589)	26 (57.3)
	100	24.5 (32.84)	78 (690.4)	82	85 (752.3)	1FT6 105 – 8WF7 ■ – ■ ■ ■ ■	4	168 (0.1487)	45.5 (100.3)
		34.2 (45.84)	109 (964.8)	81	119 (1053.3)	1FT6 108 – 8WF7 ■ – ■ ■ ■ ■ <sup>4)</sup>	4	260 (0.2301)	61.5 (135.6)

• Construction type:	IM B5 IM B14 <sup>1)</sup>	1 2
• Connector outlet direction (not available for 1FT6 108–8WF7.):	Transverse right (not for 1FT606) Transverse left (not for 1FT606) Axial non-drive end (1FT606, with water connection on top) Axial drive end (1FT606 with water connection on bottom)	1 2 3 4
• Terminal box, Cable entry (only for 1FT6 1..):	Transverse right Transverse left Axial non-drive end Axial drive end	5 6 7 8
• Encoder systems:	Incremental encoder sin/cos 1 V <sub>pp</sub> Absolute encoder EnDat, 2,048 pulses/revolution <sup>3)</sup> Resolver, multipole Resolver, 2-pole	A E S T
• Shaft end: With key and keyway With key and keyway With key and keyway With key and keyway Keyless shaft Keyless shaft Keyless shaft Keyless shaft	• Radial eccentricity tol.: N N R (not for 1FT6108) R (not for 1FT6108) N N R (not for 1FT6108) R (not for 1FT6108)	• Holding brake: No Yes No Yes No Yes No Yes
• Vibration severity grade: N N N N R R R R	• Degree of protection: IP64 IP65 IP67 IP68 IP64 IP65 IP67 IP68	A B D E G H K L
• Special models: Please specify option code; refer to page 2/9.		0 1 2 6 3 4 5 7  –Z

# Servo Motors for SIMOVERT MASTERDRIVES

## Synchronous Servo Motors

1FT6 Motors  
Water Cooling

2

### Selection and Ordering Data

Motor Type (continued)	Standstill Current  $I_0$ at $\Delta T=100\text{ K}$  A	SIMOVERT MASTERDRIVES MC Inverter/Converter Rated Current		Power Cable with Complete Shield Motor Connection with Brake Connection via Power Connector		
		$I_{\text{rated}}$ A	Order No. Inverter Converter	Power Connector  Size	Motor Cable Cross-Section <sup>2)</sup>  mm <sup>2</sup>	Order No. Pre-Assembled Cable
1FT6 108 – 8WB7 . – ....	43	47	6SE7 024 – 7 D ■ 1	3	4 x 10	6FX ■ 002 – 5 ■ A13 – ... 0
1FT6 105 – 8WC7 . – ....	58	59	6SE7 026 – 0 D ■ 1	3	4 x 16	6FX ■ 002 – 5 ■ A23 – ... 0
1FT6 108 – 8WC7 . – ....	57	59	6SE7 026 – 0 D ■ 1	3	4 x 16	6FX ■ 002 – 5 ■ A23 – ... 0
1FT6 062 – 6WF7 . – ....	6.9	10.2 8	6SE7 021 – 0 T P ■ 0 6SE7 018 – 0 E P ■ 0	1	4 x 1.5	6FX ■ 002 – 5 ■ A01 – ... 0
1FT6 064 – 6WF7 . – ....	10.3	13.2 14	6SE7 021 – 3 T P ■ 0 6SE7 021 – 4 E P ■ 0	1	4 x 1.5	6FX ■ 002 – 5 ■ A01 – ... 0
1FT6 084 – 8WF7 . – ....	24.5	34 27	6SE7 023 – 4 T P ■ 0 6SE7 022 – 7 E P ■ 0	1.5	4 x 4	6FX ■ 002 – 5 ■ A41 – ... 0
1FT6 086 – 8WF7 . – ....	34	37.5	6SE7 023 – 8 D ■ 1	1.5	4 x 6	6FX ■ 002 – 5 ■ A51 – ... 0
1FT6 105 – 8WF7 . – ....	83	92	6SE7 031 – 0 E ■ 0	3	4 x 25	6FX 5 002 – 5 D A33 – ... 0
1FT6 108 – 8WF7 . – ....	86	92	6SE7 031 – 0 E ■ 0	Terminal box PG 36	Max. connectable 4 x 35 mm <sup>2</sup>	Cable by the meter See Part 5
<ul style="list-style-type: none"> <li>• Converter</li> <li>• Inverter</li> </ul>				E T		
<ul style="list-style-type: none"> <li>• P for Compact PLUS, D for Compact devices, and E for chassis devices</li> </ul>				P D E		
<ul style="list-style-type: none"> <li>• SIMOVERT MASTERDRIVES Motion Control</li> <li>• SIMOVERT MASTERDRIVES Motion Control Performance 2</li> </ul>				5 7		
Power Cable Model <ul style="list-style-type: none"> <li>• MOTION-CONNECT 800</li> <li>• MOTION-CONNECT 500</li> </ul>					8 5	
<ul style="list-style-type: none"> <li>• Without brake cable</li> <li>• With brake cable</li> </ul>						C D

For information about length codes and signal cables, see "MOTION-CONNECT Connection System", Part 5.

#### Notes about water cooling:

- Temperature of incoming cooling water: Max. +30 °C (+86 °F)
- Cooling water throughput: at least 5 l/min (5 l: 1.1 British gallons/1.32 US gallons)
- Pressure ahead of motor:  $p_{\text{max}} = 3\text{ bar}$
- Cooling water connection: G 3/8"
- Coolant: Water (up to 25% corrosion control. recommended: Tyfocor)
- Loss of pressure between inlet and outlet < 0.1 bar

1) Same flange as IM B5, but with a helicoil in the four mounting holes.  
2) The current carrying capacity of the power cables corresponds to IEC 60204-1 for Routing Type C under continuous duty conditions at an ambient air temperature of +40 °C (+104 °F), designed for  $I_0$  (100 K) PVC/PUR insulated cable.

3) If the absolute encoder is used,  $M_{\text{rated}}$  is reduced by 10%.  
4) Motor 1FT6 108 – 8WF7 . – ... is only available in vibration severity grade N,  
5) Rating only valid for SIMOVERT MASTERDRIVES Motion Control with infeed AFE, except for shaft height 100.

# Servo Motors for SIMOVERT MASTERDRIVES

## Synchronous Servo Motors

### 1FT6 Motors Water Cooling

#### Selection and Ordering Data

Rated Rotational Speed	Shaft Height	Rated Output	Rated Torque <sup>1)</sup>	Rated Current	Standstill Torque	1FT6 Servo Motors <sup>4)</sup> Water Cooling	Pole Pair Number	Rotor Moment of Inertia (w/o Brake)	Weight (w/o Brake)
$n_{rated}$		$P_{rated}$ at $\Delta T=100\text{ K}$	$M_{rated}$ at $\Delta T=100\text{ K}$	$I_{rated}$ at $\Delta T=100\text{ K}$	$M_0$ at $\Delta T=100\text{ K}$	Order No.		$J$	
rpm	SH	kW (HP)	Nm (lb <sub>f</sub> -in)	A	Nm (lb <sub>f</sub> -in)			10 <sup>-4</sup> kgm <sup>2</sup> (lb <sub>f</sub> -in-s <sup>2</sup> )	kg (lb)
4500	63	4.7 (6.3)	10 (88.5)	9.6	10.2 (90.3)	1FT6 062 – 6WH7 ■ – ■ ■ ■ ■ ■ ■ ■ ■	3	8.5 (0.0075)	9.5 (20.9)
		7.5 (10.05)	16 (141.6)	15.2	16.2 (143.4)	1FT6 064 – 6WH7 ■ – ■ ■ ■ ■ ■ ■ ■ ■	3	13 (0.0115)	12.5 (27.6)
	80	16.5 (22.12)	35 (309.8)	39	35 (309.8)	1FT6 084 – 8WH7 ■ – ■ ■ ■ ■ ■ ■ ■ ■	4	48 (0.0425)	21 (46.3)
		21.2 (28.42)	45 (398.3)	53	47 (416)	1FT6 086 – 8WH7 ■ – ■ ■ ■ ■ ■ ■ ■ ■	4	66.5 (0.0589)	26 (57.3)
6000	63	6.2 (8.31)	9.8 (87)	12.7	10.2 (90.3)	1FT6 062 – 6WK7 ■ – ■ ■ ■ ■ ■ ■ ■ ■	3	8.5 (0.0075)	9.5 (20.9)
		9.9 (13.27)	15.8 (139.8)	20	16.2 (143.4)	1FT6 064 – 6WK7 ■ – ■ ■ ■ ■ ■ ■ ■ ■	3	13 (0.0115)	12.5 (27.6)
	80	21.4 (28.69)	34 (300.9)	51	35 (309.8)	1FT6 084 – 8WK7 ■ – ■ ■ ■ ■ ■ ■ ■ ■	4	48 (0.0425)	21 (46.3)
		27.7 (37.13)	44 (389.4)	58	47 (416)	1FT6 086 – 8WK7 ■ – ■ ■ ■ ■ ■ ■ ■ ■	4	66.5 (0.0589)	26 (57.3)

• Construction type:	IM B5 IM B14 <sup>1)</sup>	1 2
• Connector outlet direction	Transverse right (not for 1FT606) Transverse left (not for 1FT606) Axial non-drive end (1FT606, with water connection on top) Axial drive end (1FT606 with water connection on bottom)	1 2 3 4
• Encoder systems:	Incremental encoder sin/cos 1 V <sub>pp</sub> Absolute encoder EnDat, 2,048 pulses/revolution <sup>3)</sup> Resolver, multipole Resolver, 2-pole	A E S T
• Shaft end:	• Radial eccentricity tol.:	• Holding brake:
With key and keyway	N	No
With key and keyway	N	Yes
With key and keyway	R	No
With key and keyway	R	Yes
Keyless shaft	N	No
Keyless shaft	N	Yes
Keyless shaft	R	No
Keyless shaft	R	Yes
• Vibration severity grade:		• Degree of protection:
N		IP64
N		IP65
N		IP67
N		IP68
R		IP64
R		IP65
R		IP67
R		IP68
• Special models:	Please specify option code; refer to page 2/9.	0 1 2 6 3 4 5 7 -Z

# Servo Motors for SIMOVERT MASTERDRIVES

## Synchronous Servo Motors

1FT6 Motors  
Water Cooling

2

### Selection and Ordering Data

Motor Type (continued)	Standstill Current  $I_0$ at $\Delta T=100\text{ K}$  A	SIMOVERT MASTERDRIVES MC Inverter/Converter Rated Current		Power Cable with Complete Shield Motor Connection with Brake Connection via Power Connector		
		$I_{\text{rated}}$  A	Order No. Inverter Converter	Power Connector  Size	Motor Cable Cross-Section <sup>2)</sup>  mm <sup>2</sup>	Order No. Pre-Assembled Cable
1FT6 062 – 6WH7 . – ....	9.7	10.2 10	<b>6SE7 021 – 0 T P ■ 0</b> <b>6SE7 021 – 0 E P ■ 0</b>	1	4 x 1.5	<b>6FX ■ 002 – 5 ■ A01 – ... 0</b>
1FT6 064 – 6WH7 . – ....	15.4	17.5 20.5	<b>6SE7 021 – 8 T P ■ 0</b> <b>6SE7 022 – 1 E P ■ 0</b>	1	4 x 2.5	<b>6FX ■ 002 – 5 ■ A11 – ... 0</b>
1FT6 084 – 8WH7 . – ....	37	47	<b>6SE7 024 – 7 ■ D ■ 1</b>	1.5	4 x 10	<b>6FX ■ 002 – 5 ■ A61 – ... 0</b>
1FT6 086 – 8WH7 . – ....	52	59	<b>6SE7 026 – 0 ■ D ■ 1</b>	3	4 x 16	<b>6FX ■ 002 – 5 ■ A23 – ... 0</b>
1FT6 062 – 6WK7 . – ....	12.9	13.2 14	<b>6SE7 021 – 3 T P ■ 0</b> <b>6SE7 021 – 4 E P ■ 0</b>	1	4 x 1.5	<b>6FX ■ 002 – 5 ■ A01 – ... 0</b>
1FT6 064 – 6WK7 . – ....	20.5	25.5 20.5	<b>6SE7 022 – 6 T P ■ 0</b> <b>6SE7 022 – 1 E P ■ 0</b>	1	4 x 2.5	<b>6FX ■ 002 – 5 ■ A11 – ... 0</b>
1FT6 084 – 8WK7 . – ....	47	59	<b>6SE7 026 – 0 ■ D ■ 1</b>	3	4 x 10	<b>6FX ■ 002 – 5 ■ A13 – ... 0</b>
1FT6 086 – 8WK7 . – ....	59	59	<b>6SE7 026 – 0 ■ D ■ 1</b>	3	4 x 16	<b>6FX ■ 002 – 5 ■ A23 – ... 0</b>

• Converter	<b>E</b>
• Inverter	<b>T</b>
• <b>P</b> for Compact PLUS, <b>D</b> for Compact devices	<b>P</b> <b>D</b>
• SIMOVERT MASTERDRIVES Motion Control	<b>5</b>
• SIMOVERT MASTERDRIVES Motion Control Performance 2	<b>7</b>
Power Cable Model	
• MOTION-CONNECT 800	<b>8</b>
• MOTION-CONNECT 500	<b>5</b>
• Without brake cable	<b>C</b>
• With brake cable	<b>D</b>

For information about length codes and signal cables, see "MOTION-CONNECT Connection System", Part 5.

#### Notes about water cooling:

- Temperature of incoming cooling water: Max. +30 °C (+86 °F)
- Cooling water throughput: at least 5 l/min (5 l: 1.1 British gallons/1.32 US gallons)
- Pressure ahead of motor:  $p_{\text{max}} = 3\text{ bar}$
- Cooling water connection: G 3/8"
- Coolant: Water (up to 25% corrosion control, recommended: Tyfocor)
- Loss of pressure between inlet and outlet < 0.1 bar

1) Same flange as IM B5, but with a helicoil in the four mounting holes.  
2) The current carrying capacity of the power cables corresponds to IEC 60204-1 for Routing Type C under continuous duty conditions at an ambient air temperature of +40 °C (+104 °F), designed for  $I_0$  (100 K) PVC/PUR insulated cable.

3) If the absolute encoder is used,  $M_{\text{rated}}$  is reduced by 10%.  
4) Rating only valid for SIMOVERT MASTERDRIVES Motion Control with infeed AFE, except for shaft height 100.

# Servo Motors for SIMOVERT MASTERDRIVES

## Synchronous Servo Motors

### 1FT6 Big Servo Motors Water Cooling

#### Selection and Ordering Data

Rated Rotational Speed	Shaft Height	Rated Output	Rated Torque	Rated Current	Standstill Torque	1FT6 Big Servo Synchronous Motors Water Cooling	Pole Pair Number	Rotor Moment of Inertia (w/o Brake)	Weight (w/o Brake)		
$n_{\text{rated}}$		$P_{\text{rated}}$ at $\Delta T=100\text{ K}$	$M_{\text{rated}}$ at $\Delta T=100\text{ K}$	$I_{\text{rated}}$ at $\Delta T=100\text{ K}$	$M_0$ at $\Delta T=100\text{ K}$	Order No.		$J$			
rpm	SH	kW (HP)	Nm (lb <sub>f</sub> -in)	A	Nm (lb <sub>f</sub> -in)			10 <sup>-4</sup> kgm <sup>2</sup> (lb <sub>f</sub> -in-s <sup>2</sup> )	kg (lb)		
1500	132	23.6 <sup>1)</sup> (31.64) <sup>1)</sup>	150 <sup>1)</sup> (1327.7) <sup>1)</sup>	58 <sup>1)</sup>	155 (1371.9)	<b>1FT6 132 – 6WB7 6</b> – ■■■■■	3	430 (0.3805)	90 (198.5)		
		29.1 <sup>1)</sup> (39.01) <sup>1)</sup>	185 <sup>1)</sup> (1637.4) <sup>1)</sup>	67 <sup>1)</sup>	200 (1770.2)	<b>1FT6 134 – 6WB7 6</b> – ■■■■■	3	547 (0.4841)	103 (227.1)		
		36.1 (48.39)	230 (2035.7)	90	240 (2124.2)	<b>1FT6 136 – 6WB7 6</b> – ■■■■■	3	664 (0.5876)	120 (264.6)		
		45.5 (60.99)	290 (2566.8)	112	300 (2655.3)	<b>1FT6 138 – 6WB7 6</b> – ■■■■■	3	845 (0.7478)	137 (302.1)		
	160	70.7 (94.77)	450 (3983)	160	450 (3983)	<b>1FT6 163 – 8WB7 6</b> – ■■■■■	4	2300 (2.0355)	170 (374.9)		
		108.4 <sup>1)</sup> (145.31) <sup>1)</sup>	690 <sup>1)</sup> (6107.2) <sup>1)</sup>	221 <sup>1)</sup>	700 (6195.7)	<b>1FT6 168 – 8WB7 6</b> – ■■■■■	4	3100 (2.7435)	210 (463.1)		
		2500	132	35.3 <sup>1)</sup> (47.32) <sup>1)</sup>	135 <sup>1)</sup> (1194.9) <sup>1)</sup>	82 <sup>1)</sup>	155 (1371.9)	<b>1FT6 132 – 6WD7 6</b> – ■■■■■	3	430 (0.3805)	90 (198.5)
				48.4 <sup>1)</sup> (64.88) <sup>1)</sup>	185 <sup>1)</sup> (1637.4) <sup>1)</sup>	115 <sup>1)</sup>	200 (1770.2)	<b>1FT6 134 – 6WD7 6</b> – ■■■■■	3	547 (0.4841)	103 (227.1)
57.6 (77.21)	220 (1947.2)	149		240 (2124.2)	<b>1FT6 136 – 6WD7 6</b> – ■■■■■	3	664 (0.5876)	120 (264.6)			
72 (96.51)	275 (2434)	162		300 (2655.3)	<b>1FT6 138 – 6WD7 6</b> – ■■■■■	3	845 (0.7478)	137 (302.1)			
160	117.8 <sup>1)</sup> (157.91) <sup>1)</sup>	450 <sup>1)</sup> (3983) <sup>1)</sup>	240 <sup>1)</sup>	450 (3983)	<b>1FT6 163 – 8WD7 6</b> – ■■■■■	4	2300 (2.0355)	170 (374.9)			

• Construction type:	IM B35	6
• Terminal box on top, Cable entry:	Transverse right Transverse left Axial non-drive end Axial drive end	5 6 7 8
• Encoder systems:	Incremental encoder sin/cos 1 V <sub>pp</sub> Absolute encoder EnDat, 2,048 pulses/revolution Resolver, multipole Resolver, 2-pole	A E S T
• Shaft end: With key and keyway With key and keyway Keyless shaft Keyless shaft	• Radial eccentricity tol.: N N R R	• Holding brake: No No No No
• Vibration severity grade: N N R R	• Degree of protection: IP64 IP65 IP64 IP65	0 1 3 4
• Special models: Please specify option code; refer to page 2/9.		–Z

#### Notes about water cooling:

- Temperature of incoming cooling water: Max. +30 °C (+86 °F)
- Cooling water throughput: min. 8 l/min for 1FT613. ( 8 l: 1.76 British gallons/2.11 US gallons)  
min. 10 l/min for 1FT616. (10 l: 2.2 British gallons/2.64 US gallons)
- Pressure ahead of motor:  $p_{\text{max}} = 6\text{ bar}$
- Cooling water connection: G 3/8" for 1FT613.  
G 1/2" for 1FT616.
- Coolant: Water (up to 25% corrosion control. recommended: Tyfocor)
- Loss of pressure between inlet and outlet < 0.1 bar

1) Rating only valid for MASTERDRIVES Motion Control with infeed AFE.

# Servo Motors for SIMOVERT MASTERDRIVES

## Synchronous Servo Motors

1FT6 Big Servo Motors  
Water Cooling

2

### Selection and Ordering Data

Motor Type (continued)	Standstill Current  $I_0$ at $\Delta T=100\text{ K}$ A	SIMOVERT MASTERDRIVES MC Inverter/Converter Rated Current		Power Cable with Complete Shield Motor connection via terminal box		
		$I_{\text{rated}}$ A	Order No. Inverter Converter	Terminal Box Type Cable Entry	Max. Connectable Cable Cross-Section mm <sup>2</sup>	Order No. Pre-Assembled Cable By the Meter
1FT6 132 – 6WB76 – ....	58	59	<b>6SE7 026 – 0 ■ D ■ 1</b>	gk 630 2 x M32 x 1.5	2 x 4 x 16	<b>6FX ■ 008 – 1 B B61 – ... 0</b>
1FT6 134 – 6WB76 – ....	73	92	<b>6SE7 031 – 0 ■ E ■ 0</b>	gk 630 2 x M40 x 1.5	2 x 4 x 35	<b>6FX ■ 008 – 1 B B35 – ... 0</b>
1FT6 136 – 6WB76 – ....	92	92	<b>6SE7 031 – 0 ■ E ■ 0</b>	gk 630 2 x M50 x 1.5	2 x 4 x 50	<b>6FX ■ 008 – 1 B B50 – ... 0</b>
1FT6 138 – 6WB76 – ....	112	124	<b>6SE7 031 – 2 ■ F ■ 0</b>	gk 630 2 x M50 x 1.5	2 x 4 x 50	<b>6FX ■ 008 – 1 B B50 – ... 0</b>
1FT6 163 – 8WB76 – ....	160	175	<b>6SE7 032 – 1 ■ G ■ 0</b>	gk 630 2 x M50 x 1.5	2 x 4 x 50	<b>6FX ■ 008 – 1 B B50 – ... 0</b>
1FT6 168 – 8WB76 – ....	225	262	<b>6SE7 033 – 2 ■ G ■ 0</b>	gk 630 2 x M50 x 1.5	2 x 4 x 50	<b>6FX ■ 008 – 1 B B50 – ... 0</b>
1FT6 132 – 6WD76 – ....	92	92	<b>6SE7 031 – 0 ■ E ■ 0</b>	gk 630 2 x M40 x 1.5	2 x 4 x 35	<b>6FX ■ 008 – 1 B B35 – ... 0</b>
1FT6 134 – 6WD76 – ....	122	124	<b>6SE7 031 – 2 ■ F ■ 0</b>	gk 630 2 x M50 x 1.5	2 x 4 x 50	<b>6FX ■ 008 – 1 B B50 – ... 0</b>
1FT6 136 – 6WD76 – ....	158	175	<b>6SE7 032 – 1 ■ G ■ 0</b>	gk 630 2 x M50 x 1.5	2 x 4 x 50	<b>6FX ■ 008 – 1 B B50 – ... 0</b>
1FT6 138 – 6WD76 – ....	167	175	<b>6SE7 032 – 1 ■ G ■ 0</b>	gk 630 2 x M50 x 1.5	2 x 4 x 50	<b>6FX ■ 008 – 1 B B50 – ... 0</b>
1FT6 163 – 8WD76 – ....	240	262	<b>6SE7 033 – 2 ■ G ■ 0</b>	gk 630 2 x M50 x 1.5	2 x 4 x 50	<b>6FX ■ 008 – 1 B B50 – ... 0</b>

<ul style="list-style-type: none"> <li>• Converter</li> <li>• Inverter</li> </ul>	<b>E T</b>
<ul style="list-style-type: none"> <li>• <b>D</b> for Compact devices, <b>E</b> through <b>G</b> for chassis devices</li> </ul>	<b>D E F G</b>
<ul style="list-style-type: none"> <li>• SIMOVERT MASTERDRIVES Motion Control</li> <li>• SIMOVERT MASTERDRIVES Motion Control Performance 2</li> </ul>	<b>5 7</b>
Power Cable Model <ul style="list-style-type: none"> <li>• MOTION-CONNECT 800</li> <li>• MOTION-CONNECT 500</li> </ul>	<b>8 5</b>

For information about length codes and signal cables, see "MOTION-CONNECT Connection System", Part 5.

# Servo Motors for SIMOVERT MASTERDRIVES

## Synchronous Servo Motors

1FS6 Motors, Explosion-Protected  
Natural cooling



### Overview



1FS6 Explosion-Protected Synchronous Servo Motors

1FS6 motors are permanent-magnet synchronous motors for use in Zone 1 hazardous areas.

They are designed in compliance with the EEx de IIC T3 degree of protection, certified according to ATEX guidelines 94/9/EG, and also have CSA approval for Class 1, Zone 1, Temperature Class T3 (CAN/CSA-79-1-95 "Flameproof enclosure").

In addition to compliance with the applicable standards and regulations (ATEX) for potentially explosive environments, these motors also comply with the following European guidelines:

- EN 50014  
General Conditions for Electrical Equipment for Potentially Explosive Atmospheres
- EN 50018  
Standard referring to EEx d degree of protection
- EN 50019  
Standard referring to EEx e degree of protection
- EN 50021  
Standard referring to Ex nA degree of protection

Combined with the SIMOVERT MASTERDRIVES Motion Control drive system, 1FS6 motors form a powerful high-performance system. The built-in encoder systems for speed and position control can be selected specifically for the application.

These motors are designed for operation without external cooling whereby generated heat is dissipated through the motor surface.

### Uses/Benefits

- Winding insulation for Thermal Class H
- High transverse load capability
- Natural cooling motors with terminal box for power connection
- Additional terminal box for connection of encoder system and temperature sensors
- Monitoring of motor temperature with KTY 84-130 and PTC thermistor (triggering device must be certified according to test mark PTB 3x PTC-01 ATEX 3218, e. g. SIMIREL 3RN10 thermistor-motor protection).

### Application

1FS6 motors with explosion protection can be operated in Zone 1 hazardous areas and used in all such machines and industrial sectors, including:

- Flexographic printing and platen-printing machines
- Filling plants with potentially explosive vapors
- Film coating plants

Certain motors are available in core type versions. Compared to the standard models, these core types have the advantage of faster shipping time and spare part delivery. For this reason, we recommend that you configure core types.



# Servo Motors for SIMOVERT MASTERDRIVES

## Synchronous Servo Motors



1FS6 Motors, Explosion-Protected  
Natural cooling

2

### Technical Data

Motor type	AC servo motor (permanent-field synchronous motor)
Magnet material	Rare-earth magnet material
Insulation of the stator winding in accordance with EN 60034-1 (IEC 60034-1)	Temperature class H for a winding temperature rise of $\Delta T = 100$ K at an ambient temperature $+40$ °C ( $+104$ °F)
Construction type in accordance with EN 60034-7 (IEC 60034-7)	IM B5 (1FS6074 and 1FS6096) IM B35 (1FS6115 and 1FS6134)
Degree of protection in accordance with EN 60034-5 (IEC 60034-5)	IP64
Cooling	Natural cooling
Temperature monitoring	3 PTC thermistors + KTY 84 temperature sensors in the stator winding
Paint finish	Anthracite gray RAL 7016
Shaft end on the drive end in accordance with DIN 748-3 (IEC 60072-1)	Keyless shaft
Rotational accuracy, concentricity, and axial eccentricity in accordance with DIN 42955 (IEC 60072-1)	Tolerance N (normal)
Vibration severity in accordance with EN 60034-14 (IEC 60034-14)	Grade N (normal)
Bearings	Permanently lubricated deep-groove ball bearings
Encoder systems, integrated	<ul style="list-style-type: none"> <li>• Incremental encoder sin/cos 1 <math>V_{pp}</math>, 2048 pulses/revolution</li> <li>• Absolute encoder EnDat, 2,048 pulses/revolution <sup>1)</sup></li> </ul>
Connection	2 terminal boxes
Options	<ul style="list-style-type: none"> <li>• Shaft end with fitted key and keyway (half-key balancing)</li> <li>• Rotational accuracy, concentricity, and axial eccentricity Tolerance R</li> <li>• IP65 degree of protection with radial shaft seal</li> </ul>

### Characteristics

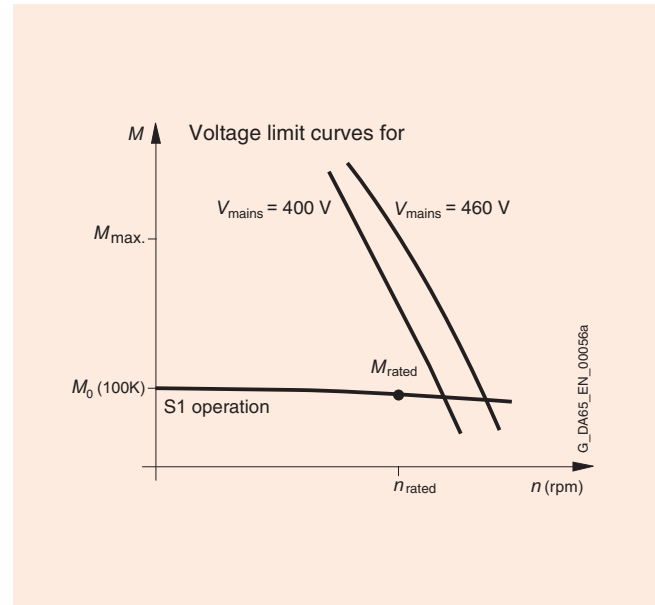

Torque-speed characteristic

### Notice

A PTC thermistor triggering device, such as SIMIREL 3RN10 thermistor motor protection, is mandatory for operating these machines in potentially explosive environments. The connection cables must be able to withstand temperatures of at least  $+100$  °C ( $+212$  °F).

1) If the absolute encoder is used,  $M_{rated}$  is reduced by 10%.

# Servo Motors for SIMOVERT MASTERDRIVES

## Synchronous Servo Motors

1FS6 Motors, Explosion-Protected, Core Type  
Natural cooling



### Selection and Ordering Data

Rated Rotational Speed	Shaft Height	Rated Output	Rated Torque <sup>1)</sup>	Rated Current	Standstill Torque	1FS6 Synchronous Motors Explosion-Protected Natural cooling	Pole Pair Number	Rotor Moment of Inertia (w/o Brake)	Weight (w/o Brake)
$n_{rated}$		$P_{rated}$ at $\Delta T=100\text{ K}$	$M_{rated}$ at $\Delta T=100\text{ K}$	$I_{rated}$ at $\Delta T=100\text{ K}$	$M_0$ at $\Delta T=100\text{ K}$	Order No. Core Type		$J$	
rpm	SH	kW (HP)	Nm (lb <sub>f</sub> -in)	A	Nm (lb <sub>f</sub> -in)			10 <sup>-4</sup> kgm <sup>2</sup> (lb <sub>f</sub> -in-s <sup>2</sup> )	kg (lb)
1500	112	5.8 (7.77)	37 (327.5)	13	40 (63.7)	1FS6 115 – 8AB7 3 – ■■■■■	4	168 (0.1487)	87 (191.8)
	132	10.7 (14.34)	68 (601.9)	22	76 (672.7)	1FS6 134 – 6AB7 3 – ■■■■■	3	547 (0.4841)	149 (328.5)
2000	71	1.5 (2.01)	7.2 (63.7)	3.4	7.6 (67.3)	1FS6 074 – 6AC7 1 – ■■■■■	3	13 (0.0115)	29 (63.9)
	90	4.2 (5.63)	20 (177)	9.8	22 (194.7)	1FS6 096 – 8AC7 1 – ■■■■■	4	66.5 (0.0589)	55 (121.3)
	112	7.1 (9.52)	34 (300.9)	16	40 (63.7)	1FS6 115 – 8AC7 3 – ■■■■■	4	168 (0.1487)	87 (191.8)
	132	12.4 (16.62)	59 (522.2)	24	76 (672.7)	1FS6 134 – 6AC7 3 – ■■■■■	3	547 (0.4841)	149 (328.5)
3000	71	2 (2.68)	6.3 (55.8)	4.4	7.6 (67.3)	1FS6 074 – 6AF7 1 – ■■■■■	3	13 (0.0115)	29 (63.9)
	90	5.3 (7.1)	17 (150.5)	12	22 (194.7)	1FS6 096 – 8AF7 1 – ■■■■■	4	66.5 (0.0589)	55 (121.3)
	112	8.8 (11.8)	28 (247.8)	20	40 (63.7)	1FS6 115 – 8AF7 3 – ■■■■■	4	168 (0.1487)	87 (191.8)
4500	71	2.1 (2.86)	4.5 (39.8)	5	7.6 (67.3)	1FS6 074 – 6AH7 1 – ■■■■■	3	13 (0.0115)	29 (63.9)
	90	5.2 (6.97)	11 (97.4)	11.5	22 (194.7)	1FS6 096 – 8AH7 1 – ■■■■■	4	66.5 (0.0589)	55 (121.3)
6000	71	1.2 (1.61)	1.9 (16.8)	3.2	7.6 (67.3)	1FS6 074 – 6AK7 1 – ■■■■■	3	13 (0.0115)	29 (63.9)

• Construction type:	IM B5 (only for 1FS607 and 1FS609) IM B35 (only for 1FS611 and 1FS613)	1 3
• Terminal box for power and encoder connection:	Cable entry transverse right Cable entry transverse left Cable entry axial non-drive end Cable entry axial drive end	5 6 7 8
• Encoder systems:	Incremental encoder sin/cos 1 V <sub>pp</sub> Absolute encoder EnDat, 2,048 pulses/revolution <sup>1)</sup>	A E
• Shaft end: Keyless shaft With key and keyway Keyless shaft With key and keyway	• Radial eccentricity tolerance: N N R R	G A K D
• Vibration severity grade: N N	• Degree of protection: IP64 IP65 with radial shaft seal	0 1

# Servo Motors for SIMOVERT MASTERDRIVES

## Synchronous Servo Motors



1FS6 Motors, Explosion-Protected, Core Type  
Natural cooling

2

### Selection and Ordering Data

Motor Type (continued)	Standstill Current  $I_0$ at $\Delta T=100\text{ K}$ A	SIMOVERT MASTERDRIVES MC Inverter/Converter Rated Current		Power Cable with Complete Shield Motor connection via terminal box	
		$I_{\text{rated}}$ A	Order No. Inverter Converter	Motor Cable Cross-Section <sup>2)</sup> mm <sup>2</sup>	Order No. Preassembled Cable No Connector, Prepared Wire Ends
1FS6 115 – 8AB73 – ....	13	13.2 14	<b>6SE7 021 – 3TP</b> ■ 0 <b>6SE7 021 – 4EP</b> ■ 0	4 x 1.5	<b>6FX5 002 – 5XA00 – ■ ■ ■ 0</b>
1FS6 134 – 6AB73 – ....	22	25.5 27	<b>6SE7 022 – 6TP</b> ■ 0 <b>6SE7 022 – 7EP</b> ■ 0	4 x 4	<b>6FX5 002 – 5XA20 – ■ ■ ■ 0</b>
1FS6 074 – 6AC71 – ....	3.4	4 5	<b>6SE7 014 – 0TP</b> ■ 0 <b>6SE7 015 – 0EP</b> ■ 0	4 x 1.5	<b>6FX5 002 – 5XA00 – ■ ■ ■ 0</b>
1FS6 096 – 8AC71 – ....	9.2	10.2 10	<b>6SE7 021 – 0TP</b> ■ 0 <b>6SE7 021 – 0EP</b> ■ 0	4 x 1.5	<b>6FX5 002 – 5XA00 – ■ ■ ■ 0</b>
1FS6 115 – 8AC73 – ....	18	17.5 20.5	<b>6SE7 021 – 8TP</b> ■ 0 <b>6SE7 022 – 1EP</b> ■ 0	4 x 2.5	<b>6FX5 002 – 5XA10 – ■ ■ ■ 0</b>
1FS6 134 – 6AC73 – ....	29	25.5 27	<b>6SE7 022 – 6TP</b> ■ 0 <b>6SE7 022 – 7EP</b> ■ 0	4 x 4	<b>6FX5 002 – 5XA20 – ■ ■ ■ 0</b>
1FS6 074 – 6AF71 – ....	4.8	6.1 5	<b>6SE7 016 – 0TP</b> ■ 0 <b>6SE7 015 – 0EP</b> ■ 0	4 x 1.5	<b>6FX5 002 – 5XA00 – ■ ■ ■ 0</b>
1FS6 096 – 8AF71 – ....	14	13.2 14	<b>6SE7 021 – 3TP</b> ■ 0 <b>6SE7 021 – 4EP</b> ■ 0	4 x 1.5	<b>6FX5 002 – 5XA00 – ■ ■ ■ 0</b>
1FS6 115 – 8AF73 – ....	26	25.5 27	<b>6SE7 022 – 6TP</b> ■ 0 <b>6SE7 022 – 7EP</b> ■ 0	4 x 4	<b>6FX5 002 – 5XA20 – ■ ■ ■ 0</b>
1FS6 074 – 6AH71 – ....	7.2	6.1 5	<b>6SE7 016 – 0TP</b> ■ 0 <b>6SE7 015 – 0EP</b> ■ 0	4 x 1.5	<b>6FX5 002 – 5XA00 – ■ ■ ■ 0</b>
1FS6 096 – 8AH71 – ....	19	13.2 14	<b>6SE7 021 – 3TP</b> ■ 0 <b>6SE7 021 – 4EP</b> ■ 0	4 x 1.5	<b>6FX5 002 – 5XA00 – ■ ■ ■ 0</b>
1FS6 074 – 6AK71 – ....	9.6	4 5	<b>6SE7 014 – 0TP</b> ■ 0 <b>6SE7 015 – 0EP</b> ■ 0	4 x 1.5	<b>6FX5 002 – 5XA00 – ■ ■ ■ 0</b>

- SIMOVERT MASTERDRIVES Motion Control
- SIMOVERT MASTERDRIVES Motion Control Performance 2

5  
7

For information about length codes and power cables, see “MOTION-CONNECT Connection System”, Part 5.

### Ordering Data for Signal Cables

Signal Cables with Complete Shield	Order No.
• Incremental encoder sin/cos 1 V <sub>pp</sub>	<b>6FX5 002 – 2XA00 – ■ ■ ■ 0</b>
• Absolute encoder EnDat	<b>6FX5 002 – 2XQ10 – ■ ■ ■ 0</b>
• PTC thermistor (for connection to 3RN10 triggering device)	<b>6FX5 002 – 1XA04 – ■ ■ ■ 0</b>

1) If the absolute encoder is used,  $M_{\text{rated}}$  is reduced by 10%.

2) The current carrying capacity of the power cables corresponds to IEC 60204-1 for Routing Type C under continuous duty conditions at an ambient air temperature of +40 °C (+104 °F), designed for  $I_{\text{rated}}$  (100 K) PVC/PUR insulated cable.

# Servo Motors for SIMOVERT MASTERDRIVES

## Synchronous Servo Motors

### 1FW3 Torque Motors Water Cooling

#### Overview

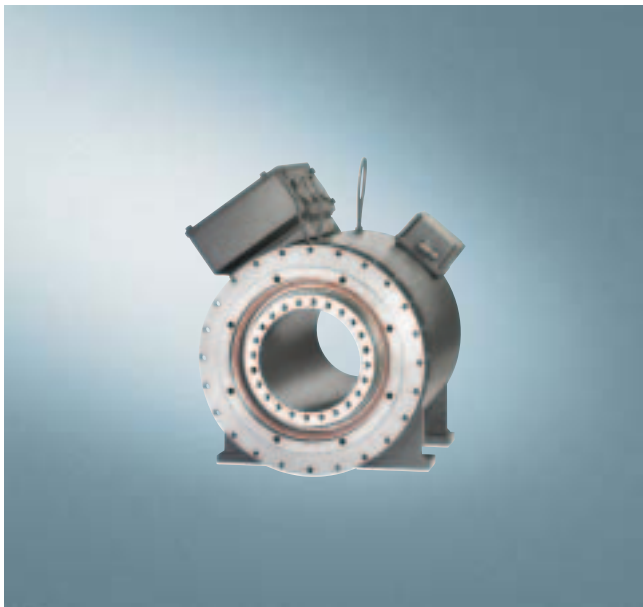

1FW3 Torque Motors

1FW3 complete torque motors 1FW3 are liquid-cooled, high-pole (slow running) permanent-magnet synchronous servo motors with hollow-shaft rotor. The operating characteristics are essentially comparable to those of regular servo synchronous motors.

The 1FW3 complete torque motor ships as a fully assembled, complete unit. The range includes 2 outer diameters with various shaft lengths. The stator and the rotor have a flange with centering surfaces and tapped holes at the drive end (A end) which allow them to be integrated into the customer's machine.

Combined with the SIMOVERT MASTERDRIVES Motion Control drive system, 1FW3 torque motors form a powerful high-performance system. The built-in encoder systems for speed and position control can be selected specifically for the application.

#### Uses/Benefits

- High torque with a compact design and small construction dimensions
- High overload capacity
- No elasticity in the drive train
- No torsional backlash
- High availability, as the drive train contains no gearbox components that are subject to wear
- Low moment of inertia
- Directly flanged to the machine
- Hollow-shaft rotor design allows for flexible installation concepts

#### Application

- Extruder main drive
- Worm drives for injection molding machines
- Pull-roll drives for foil-stretching machines
- Roller drives in paper machines
- Cross-cutter drives in paper machines
- Packaging and textile machines
- Wire-drawing machines

# Servo Motors for SIMOVERT MASTERDRIVES

## Synchronous Servo Motors

1FW3 Torque Motors  
Water Cooling

### Technical Data

Motor type	Permanent-magnet synchronous motor
Magnet material	Rare-earth magnet material
Insulation of the stator winding (in accordance with EN 60034-1, IEC 60034-1)	Temperature class F for a winding temperature rise of $\Delta T = 100$ K at a coolant (water) inlet temperature of $+25$ °C ( $+77$ °F)
Construction type (in accordance with EN 60034-7 and IEC 60034-7)	IM B14 for shaft height 200 IM B35 for shaft height 280
Degree of protection (in accordance with EN 60034-5 and IEC 60034-5)	IP54
Cooling (in accordance with EN 60034-6 and IEC 60034-6)	Water cooling
Thermal motor protection (in accordance with EN 60034-11 and IEC 60034-11)	KTY 84 temperature sensor in stator winding
Paint finish	Anthracite (RAL 7016)
2nd rating plate	A second rating plate is provided for all motors
Shaft end (in accordance with DIN 748-3 and IEC 60072-1)	Hollow shaft Inside diameter $d_i = 152$ mm (5.98 in) for SH 200 Inside diameter $d_i = 250$ mm (9.84 in) for SH 280
Radial eccentricity, concentricity, and axial eccentricity (in accordance with DIN 42955 and IEC 60072-1)	Tolerance class N (normal)
Vibration severity (in accordance with EN 60034-14 and IEC 60034-14)	Grade N (normal)
Sound pressure level (in accordance with EN 1680)	1FW320. 70 dB (A) + 3 dB (A) Tol. 1FW328. 70 dB (A) + 3 dB (A) Tol.
Flange accuracy	Grade N (normal)
Bearings	Roller bearings with permanent grease lubrication (lubrication over the bearing lifetime). Relubrication unit (optional)
Encoder systems, integrated	<ul style="list-style-type: none"> <li>• Resolver, multipole, <math>2p=8</math>, Standard</li> <li>• Incremental encoder sin/cos <math>1 V_{pp}</math>, (I-2,048), optional</li> <li>• Absolute encoder EnDat <sup>1)</sup> (A-2,048), optional</li> </ul>
Connection	Terminal box for power cable Connector for encoder signals and KTY 84

### Characteristics

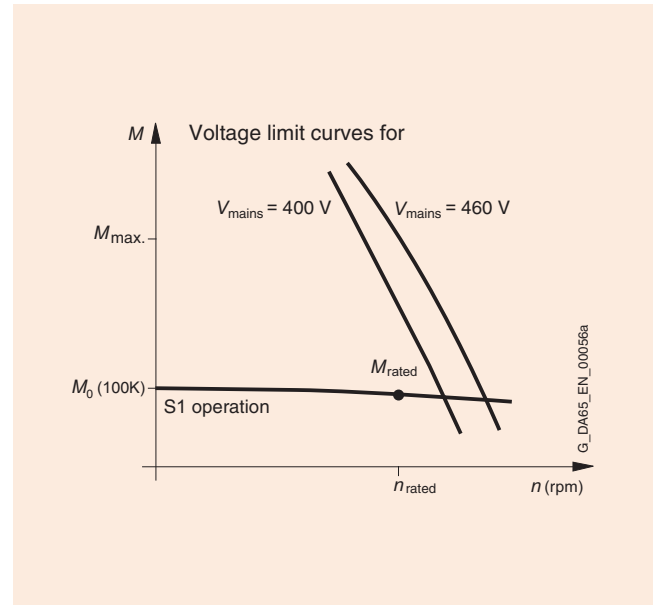

Torque-speed characteristic

2

1) The "Multiturn Absolute Value" function will be available in October 2004.

# Servo Motors for SIMOVERT MASTERDRIVES

## Synchronous Servo Motors

### 1FW3 Torque Motors Water Cooling

#### Selection and Ordering Data

Rated Rotational Speed	Shaft Height	Rated Output	Rated Torque	Rated Current	Standstill Torque	1FW3 Torque Motors Water Cooling	Pole Pair Number	Rotor Moment of Inertia	Weight
$n_{rated}$		$P_{rated}$ at $\Delta T=100\text{ K}$	$M_{rated}$ at $\Delta T=100\text{ K}$	$I_{rated}$ at $\Delta T=100\text{ K}$	$M_0$ at $\Delta T=100\text{ K}$	Order No.		$J$	
rpm	SH	kW (HP)	Nm (lb <sub>f</sub> -in)	A	Nm (lb <sub>f</sub> -in)			10 <sup>-4</sup> kgm <sup>2</sup> (lb <sub>f</sub> -in-s <sup>2</sup> )	kg (lb)
<b>250</b>	200	7.9 (10.59)	300 (221.3)	24	315 (232.3)	<b>1FW3 201 – 1 H7 2 – A A 0</b>	14	0.22 (0.0002)	127 (280)
		13.1 (17.56)	500 (368.8)	40	525 (387.2)	<b>1FW3 202 – 1 H7 2 – A A 0</b>	14	0.35 (0.0003)	156 (344)
		19.6 (26.27)	750 (553.2)	63	788 (581.2)	<b>1FW3 203 – 1 H7 2 – A A 0</b>	14	0.47 (0.0004)	182 (401.3)
		26.2 (35.12)	1000 (737.6)	80	1050 (774.5)	<b>1FW3 204 – 1 H7 2 – A A 0</b>	14	0.6 (0.0005)	232 (511.6)
		39.3 (52.68)	1500 (1106.4)	124	1575 (1161.7)	<b>1FW3 206 – 1 H7 2 – A A 0</b>	14	0.85 (0.0007)	279 (615.2)
		52.3 (70.11)	2000 (1475.2)	164	2100 (1549)	<b>1FW3 208 – 1 H7 2 – A A 0</b>	14	1.1 (0.001)	348 (767.3)
<b>200</b>	280	52.3 (70.11)	2500 (1844)	170	262 (1936.2)	<b>1FW3 281 – 1 G7 3 – A A 0</b>	17	4.4 (0.0039)	628 (1384.7)
		73.3 (98.26)	3500 (2581.6)	245	3675 (2710.7)	<b>1FW3 283 – 1 G7 3 – A A 0</b>	17	5.8 (0.0051)	731 (1611.9)
		104.7 (140.35)	5000 (3688)	340	5250 (3872.4)	<b>1FW3 285 – 1 G7 3 – A A 0</b>	17	7.9 (0.007)	885 (1951.9)
		146.5 (196.38)	7000 (5163.2)	486	7350 (5421.4)	<b>1FW3 288 – 1 G7 3 – A A 0</b>	17	10.7 (0.0095)	1090 (2403.5)

• Encoder systems:	Incremental encoder sin/cos 1 V <sub>pp</sub> Absolute encoder EnDat, 2,048 pulses/revolution <sup>1)</sup> Resolver, multipole	<b>A</b> <b>E</b> <b>S</b>
• Construction type:	IM B14 (for shaft height 200) IM B35 (for shaft height 280)	<b>2</b> <b>3</b>
• Terminal box on top:	Cable outlet diagonally to the right Cable outlet diagonally to the left Cable outlet axial non-drive end Cable outlet axial drive end	<b>5</b> <b>6</b> <b>7</b> <b>8</b>

Other rated speeds on request.

1) The "Multiturn Absolute Value" function will be available in October 2004.

# Servo Motors for SIMOVERT MASTERDRIVES

## Synchronous Servo Motors

1FW3 Torque Motors  
Water Cooling

2

### Selection and Ordering Data

Motor Type (continued)	Standstill Current  $I_0$ at $\Delta T=100\text{ K}$  A	SIMOVERT MASTERDRIVES MC Inverter/Converter Rated Current		Power Cable with Complete Shield Motor connection via terminal box		
		$I_{\text{rated}}$  A	Order No. Inverter Converter	Terminal box type Cable entry	Cable Cross- section Motor 1) Max. possible cross section mm <sup>2</sup>	Order No. Pre-Assembled Cable By the Meter
1FW3 201 – 1 . H72 – . AA0	25	25.5 25.5	<b>6SE7 022 – 6 T P 7 0</b> <b>6SE7 022 – 7 E P 7 0</b>	gk 230 1 x M32 x 1.5	<b>4 x 4</b> 4 x 16	<b>6FX 008 – 1BB31 – ■ ■ A0</b> 6FX 008 – 1BB61 – ■ ■ A0
1FW3 202 – 1 . H72 – . AA0	42	47 47	<b>6SE7 024 – 7 T D 7 1</b> <b>6SE7 024 – 7 E D 7 1</b>	gk 230 1 x M32 x 1.5	<b>4 x 10</b> 4 x 16	<b>6FX 008 – 1BB51 – ■ ■ A0</b> 6FX 008 – 1BB61 – ■ ■ A0
1FW3 203 – 1 . H72 – . AA0	66	72 72	<b>6SE7 027 – 2 T D 7 1</b> <b>6SE7 027 – 2 E D 7 1</b>	gk 420 1 x M40 x 1.5	<b>4 x 16</b> 4 x 35	<b>6FX 008 – 1BB61 – ■ ■ A0</b> 6FX 5 008 – 1BB35 – ■ ■ A0
1FW3 204 – 1 . H72 – . AA0	83	92 92	<b>6SE7 031 – 0 T E 7 0</b> <b>6SE7 031 – 0 E E 7 0</b>	gk 420 1 x M40 x 1.5	<b>4 x 25</b> 4 x 35	<b>6FX 5 008 – 1BB25 – ■ ■ A0</b> 6FX 5 008 – 1BB35 – ■ ■ A0
1FW3 206 – 1 . H72 – . AA0	131	124 124	<b>6SE7 031 – 2 T F 7 0</b> <b>6SE7 031 – 2 E F 7 0</b>	gk 630 2 x M50 x 1.5	<b>4 x 70</b> 2 x 4 x 50	<b>6FX 5 008 – 1BB70 – ■ ■ A0</b> 6FX 5 008 – 1BB50 – ■ ■ A0
1FW3 208 – 1 . H72 – . AA0	172	175 175	<b>6SE7 032 – 1 T G 7 0</b> <b>6SE7 032 – 1 E G 7 0</b>	gk 630 2 x M50 x 1.5	<b>2 x 4 x 50</b> 2 x 4 x 50	<b>6FX 5 008 – 1BB50 – ■ ■ A0</b> 6FX 5 008 – 1BB50 – ■ ■ A0
1FW3 281 – 1 . G73 – . AA0	179	175 175	<b>6SE7 032 – 1 T G 7 0</b> <b>6SE7 032 – 1 E G 7 0</b>	1XB7 700 3 x M75 x 1.5	<b>2 x 4 x 50</b> 3 x 4 x 120	<b>6FX 5 008 – 1BB50 – ■ ■ A0</b> 6FX 5 008 – 1BB12 – ■ ■ A0
1FW3 283 – 1 . G73 – . AA0	257	262 262	<b>6SE7 033 – 2 T G 7 0</b> <b>6SE7 033 – 2 E G 7 0</b>	1XB7 700 3 x M75 x 1.5	<b>2 x 4 x 70</b> 3 x 4 x 120	<b>6FX 5 008 – 1BB70 – ■ ■ A0</b> 6FX 5 008 – 1BB12 – ■ ■ A0
1FW3 285 – 1 . G73 – . AA0	357	423 423	<b>6SE7 035 – 1 T J 7 0</b> <b>6SE7 035 – 1 E K 7 0</b>	1XB7 700 3 x M75 x 1.5	<b>2 x 4 x 95</b> 3 x 4 x 120	<b>6FX 5 008 – 1BB05 – ■ ■ A0</b> 6FX 5 008 – 1BB12 – ■ ■ A0
1FW3 288 – 1 . G73 – . AA0	510	491 491	<b>6SE7 036 – 0 T J 7 0</b> <b>6SE7 036 – 0 E K 7 0</b>	1XB7 700 3 x M75 x 1.5	<b>3 x 4 x 95</b> 3 x 4 x 120	<b>6FX 5 008 – 1BB05 – ■ ■ A0</b> 6FX 5 008 – 1BB12 – ■ ■ A0
<ul style="list-style-type: none"> <li>• Inverter</li> <li>• Converter</li> </ul>				<b>T</b> <b>E</b>		
• SIMOVERT MASTERDRIVES Motion Control Performance 2				<b>7</b>		
Power Cable Model						
<ul style="list-style-type: none"> <li>• MOTION-CONNECT 800</li> <li>• MOTION-CONNECT 500</li> </ul>					<b>8</b> <b>5</b>	

For information about length codes for power cables and signal cables, see “MOTION-CONTROL Connection System”, Part 5.

1) The current carrying capacity of the power cables corresponds to IEC 60204-1 for **Routing Type C** under continuous duty conditions at an ambient air temperature of +40 °C (+104 °F), designed for  $I_0$  (100 K) PVC/PUR insulated cable.

The second line contains the maximum number of cable cross-sections that can be connected for other environmental conditions or routing types.  
PATH can be used to configure different environmental conditions.



# Servo Motors for SIMOVERT MASTERDRIVES

## Synchronous Servo Motors

Notes

2



# Asynchronous Servo Motors

# 3



<b>3/2</b>	<b>1PH7 Motors</b>
<b>3/44</b>	<b>1PL6 Motors</b>
<b>3/70</b>	<b>1PH4 Motors</b>

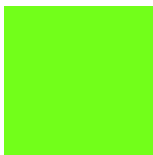

# Servo Motors for SIMOVERT MASTERDRIVES

## Asynchronous Servo Motors

### 1PH7 Motors

#### Overview



1PH7 AC Motors, Shaft Height 100 to 160



1PH7 AC Motors, Shaft Height 180 and 225



1PH7 AC Motors, Shaft Height 280

The AC motors in the 1PH7 series are compact, forced ventilated asynchronous motors with a squirrel cage rotor with IP65 degree of protection. A built-on external ventilation unit is the standard means of ventilation for these motors.

1PH7 motors can be ordered with an air flow from the motor shaft (drive end) toward the back of the motor (non-drive end) or an air flow in the opposite direction.

These motors were developed especially for operation on the SIMOVERT MASTERDRIVES Vector Control and Motion Control drive system. Depending on the control requirements, appropriate encoder systems for measuring motor speed and indirect positions are available for these motors.

#### Uses/Benefits

- High power density with small motor dimensions
- High degree of protection
- Wide speed control range
- Speed to zero without torque reduction
- Robustness
- Very little maintenance required
- High transverse load capability
- High rotational accuracy even at very low speeds
- Integrated encoder system for measuring motor speed, connected via connectors
- Terminal boxes for connecting power cables
- KTY 84 monitoring of motor temperature
- Variable ventilation systems
- Simple external ventilation through pipe connection
- Bearing with relubrication unit and insulated bearing (non-drive end) options

#### Application

For use in dry, indoor installations (not in corrosive atmospheres)

Hoisting equipment:

- Hoisting and grab-closing gear for cranes
- Hoisting and traveling gear for rack feeders

Printing industry

- Single and main drives for printing machines

Manufacture of rubber, plastics, wire, and glass:

- Drives for extruders, calanders, rubber-injection plants, plastic film machines, and tile-making plants
- Wire-drawing machines, wire-stranding machines, etc.

General applications such as coiler and winder drives

# Servo Motors for SIMOVERT MASTERDRIVES

## Asynchronous Servo Motors

1PH7 Motors

### Technical Data

Insulation of the stator winding in acc. with EN 60034-1 (IEC 60034-1)	Temperature class F for a coolant temperature up to +40 °C (+104 °F)
Fan connection adjustment (See Technical Data, Part 7)	400 V 3-phase AC/50 Hz/60 Hz 480 V 3-phase AC/60 Hz
Construction type in acc. with EN 60034-7 (IEC 60034-7)	IM B3
Degree of protection in acc. with EN 60034-5 (IEC 60034-5)	IP55 (fan, IP54)
Cooling in accordance with EN 60034-6 (IEC 60034-6)	Forced ventilation SH 100 to 225: Fan built onto axial non-drive end SH 280: Fan built onto radial non-drive end
Temperature monitoring	KTY 84 temperature in the stator winding SH 280: Additional KTY 84 as spare
Paint finish	SH 100 to 160: Unpainted, Standard paint finish, anthracite gray RAL 7016 SH 180 to 280: Primed, Standard paint finish, anthracite gray RAL 7016
Shaft end on the drive end in acc. with DIN 748-3 (IEC 60072-1)	With keyway, half-key balancing
Shaft and flange accuracy in accordance with DIN 42955 (IEC 60072-1)	SH 100 to 160: Tolerance R (reduced) SH 180 to 280: Tolerance N (normal)
Vibration severity grade in accordance with EN 60034-14 (IEC 60034-14)	SH 100 to 225: Grade R (reduced) SH 280: Grade N (normal)
Sound pressure level according to EN 1680 Tolerance +3 dB	Sound pressure level depends on direction of ventilation See Part 7
Bearing designs and Maximum speeds	See Part 7
Encoder system, integrated	- Incremental encoder HTL 1,024 pulses/revolution - Incremental encoder sin/cos 1 V <sub>pp</sub> , 2,048 pulses/revolution - Absolute encoder EnDat 2,048 pulses/revolution - Resolver, 2-pole
Connection	Connectors for signals (Mating connector not included) Terminal box for power SH 160 to 225: Terminal box on top SH 280: Terminal box non-drive end, on right
Options	See Selection and Ordering Data and Options table on this page

### Characteristics

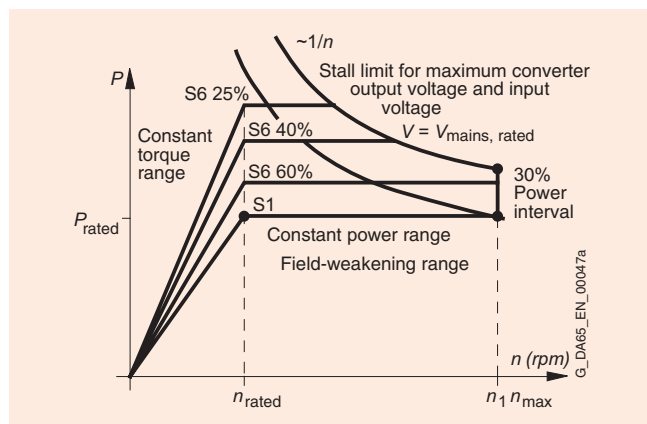

Power-Speed Curve

### Options

Code	Option Description	In 1PH7 Asynchronous Servo Motor Type		
		SH 100 to 160	SH 180 SH 225	SH 280
	Standard paint finish in another color RAL ...	● <sup>1)</sup>	■ <sup>2)</sup>	■ <sup>2)</sup>
	Special paint finish in another color RAL ...	●	■ <sup>3)</sup>	■ <sup>3)</sup>
<b>C30</b>	690 V winding	-	-	■
<b>G14</b>	Fan group with air filter	-	●	■
<b>G80</b>	POG 10 pulse encoder, Prepared attachment	-	-	■
<b>K08</b>	Encoder connector attachment facing	-	-	■
<b>K16</b>	Additional normal shaft end (only available with no encoder)	-	-	■
<b>K31</b>	2nd rating plate comes unattached in terminal box	Standard	■	■
<b>K40</b>	Relubrication, drive end and non-drive end	-	■	Standard
<b>K45</b>	230 V standstill heating	-	-	■
<b>K55</b>	Customer-specific entry plate for terminal box (Plain text required)	-	■	■
<b>K83</b>	Terminal box rotation by + 90 degrees (from standard position)	-	-	■
<b>K84</b>	Terminal box rotation by - 90 degrees (from standard position)	-	-	■
<b>K85</b>	Terminal box rotation by +180 degrees (from standard position)	-	-	■
<b>L27</b>	Insulated non-drive end bearing	-	■	Standard
<b>M03</b>	Design for Zone 2 hazardous areas (in accordance with EN 50021/IEC 60079-15)	■	-	-
<b>M39</b>	Design for Zone 22 hazardous areas (in accordance with EN 50281/IEC 61241)	■	■	■
<b>M83</b>	Additional pulling thread on motor feet	-	-	■
<b>Y55</b>	Atypical shaft end, drive side	●	●	●
<b>Y80</b>	Different rating plate data (plain text required)	●	●	●
<b>Y82</b>	Additional plate with customer information	●	●	●

- Option available
- On request
- Not available

- 1) Order by indicating option code (no plain text), e. g.:  
X01: RAL 9005 (jet black)  
X02: RAL 9001 (cream)  
X03: RAL 6011 (reseda green)  
X04: RAL 7032 (pebble gray)  
X05: RAL 5015 (sky blue)  
X06: RAL 1015 (light ivory)
- 2) Order with code: R1Y  
(Plain text required when specifying RAL color).
- 3) Order with code: R2Y  
(Plain text required when specifying RAL color).

# Servo Motors for SIMOVERT MASTERDRIVES

## Asynchronous Servo Motors

### 1PH7 Motors

#### Selection and Ordering Data with SIMOVERT MASTERDRIVES Vector Control

Rated Rotational Speed $n_{rated}$ rpm	Shaft Height SH	Rated Output $P_{rated}$ kW (HP)	Rated Torque $M_{rated}$ Nm (lb <sub>f</sub> -ft)	Rated Current $I_{rated}$ A	Rated Voltage $V_{rated}$ V	Speed during Field Weakening <sup>1)</sup> $n_1$ rpm	Max. Permissible Continuous Speed <sup>2)</sup> $n_{S1}$ rpm	Max. Speed <sup>3)</sup> $n_{max}$ rpm	1PH7 Asynchronous Motors Order No.
<b>Supply voltage 3-ph. AC 400 V for SIMOVERT MASTERDRIVES Vector Control</b>									
<b>400</b>	160	9.5 (12.74)	227 (167.4)	30	274	2000	2000	2000	<b>1PH7 163</b> – ■ ■ B ■ ■ – ■ ...
		13 (17.43)	310 (228.7)	37	294	1600	2000	2000	<b>1PH7 167</b> – ■ ■ B ■ ■ – ■ ...
<b>1150</b>	100	4.3 (5.76)	36 (26.6)	10	391	2200	5500	5750	<b>1PH7 103</b> – ■ ■ D ■ ■ – ■ ...
		7.2 (9.65)	60 (44.3)	17,5	360	3000	5500	5750	<b>1PH7 107</b> – ■ ■ D ■ ■ – ■ ...
	132	13.5 (18.1)	112 (82.6)	29	381	2500	4500	5750	<b>1PH7 133</b> – ■ ■ D ■ ■ – ■ ...
		19.5 (26.14)	162 (119.5)	43	367	2600	4500	5750	<b>1PH7 137</b> – ■ ■ D ■ ■ – ■ ...
	160	25 (33.51)	208 (153.4)	55	364	3400	3700	5750	<b>1PH7 163</b> – ■ ■ D ■ ■ – ■ ...
		31 (41.56)	257 (189.6)	70	357	3700	3700	5750	<b>1PH7 167</b> – ■ ■ D ■ ■ – ■ ...
<b>1750</b>	100	4.3 (5.76)	24 (17.7)	10	398	4600	5500	8750	<b>1PH7 101</b> – ■ ■ F ■ ■ – ■ ...
		6.25 (8.38)	34 (25.1)	13,0	398	2600	5500	8750	<b>1PH7 103</b> – ■ ■ F ■ ■ – ■ ...
		8.0 (10.72)	44 (32.5)	17,5	398	4500	5500	8750	<b>1PH7 105</b> – ■ ■ F ■ ■ – ■ ...
		10.0 (13.4)	55 (40.6)	23	381	4200	5500	8750	<b>1PH7 107</b> – ■ ■ F ■ ■ – ■ ...

#### • Separate fan:

- With separate fan
- Without separate fan, for pipe connection
- With separate fan, but with metric cable entries in accordance with EN 50262
- Without separate fan, for pipe connection, but with metric cable entries in accordance with EN 50262

2  
6  
7  
8

#### • Encoder:

- Without encoder
- Incremental encoder HTL (1,024 pulses/revolution)
- Incremental encoder HTL (2,048 pulses/revolution)

A  
H  
J

#### • Terminal box arrangement/direction of cable entry (drive-end view):

- On top/from right
- On top/from non-drive end
- On top/from left

0  
2  
3

#### • Construction type:

- IM B3 (IM V5, IM V6)
- IM B5 (IM V1, IM V3) available only for shaft height 100 and 132
- IM B35 (IM V15, IM V36)

0  
2  
3

#### • Holding brake with emergency stop function:<sup>4)</sup>

- Without brake
- Brake connection voltage: **230 V AC, 50 to 60 Hz**
- With brake
- With brake (brake includes microswitch)
- With brake (brake includes manual release)
- With brake (brake includes manual release and microswitch)
- Brake connection voltage: **24 V DC**
- With brake
- With brake (brake includes microswitch)
- With brake (brake includes manual release)
- With brake (brake includes manual release and microswitch)

0  
1  
2  
3  
4  
5  
6  
7  
8

For order number supplements for drive type, direction of air flow, and paint finish (positions 14 through 16 of the order no.), see page 3/5.

# Servo Motors for SIMOVERT MASTERDRIVES

## Asynchronous Servo Motors

1PH7 Motors

3

### Selection and Ordering Data with SIMOVERT MASTERDRIVES Vector Control

Power Factor	Magnetizing Current $I_{\mu}$ A	Rated Efficiency $\eta_{rated}$	Rated Frequency $f_{rated}$ Hz	Moment of inertia $J$ kgm <sup>2</sup> (lb <sub>f</sub> -in-s <sup>2</sup> )	Weight, approx. kg (lb)	1PH7 Asynchronous Motors		SIMOVERT MASTERDRIVES VC Inverter/Converter Rated Current	
						Order No.	$I_{rated}$ A	Order No.	
<b>Supply voltage 3-ph. AC 400 V for SIMOVERT MASTERDRIVES Vector Control</b>									
0.88	11.5	0.809	14.3	0.185 (1.6372)	175 (385.9)	1PH7 163 - . . . B . . . . ■■■■	34	6SE7 023 - 4 ■ P60	
0.88	14	0.814	14.3	0.228 (2.0178)	210 (463.1)	1PH7 167 - . . . B . . . . ■■■■	37.5	6SE7 023 - 8 ■ D61	
0.81	5.0	0.813	40.6	0.017 (0.1504)	40 (88.2)	1PH7 103 - . . . D . . . . ■■■■	10	6SE7 021 - 0 ■ P60	
0.81	8.8	0.838	40.3	0.029 (0.2566)	65 (143.3)	1PH7 107 - . . . D . . . . ■■■■	20.5	6SE7 022 - 1 E P60	
0.85	13	0.877	39.7	0.076 (0.6726)	90 (198.5)	1PH7 133 - . . . D . . . . ■■■■	34	6SE7 023 - 4 ■ P60	
0.86	19	0.887	39.6	0.109 (0.9646)	150 (330.8)	1PH7 137 - . . . D . . . . ■■■■	47	6SE7 024 - 7 ■ D61	
0.84	25	0.904	39.2	0.185 (1.6372)	175 (385.9)	1PH7 163 - . . . D . . . . ■■■■	59	6SE7 026 - 0 ■ D61	
0.83	34	0.909	39.1	0.228 (2.0178)	210 (463.1)	1PH7 167 - . . . D . . . . ■■■■	72	6SE7 027 - 2 ■ D61	
0.75	5.7	0.855	60.0	0.017 (0.1504)	40 (88.2)	1PH7 101 - . . . F . . . . ■■■■	10	6SE7 021 - 0 ■ P60	
0.84	5.3	0.849	61.0	0.017 (0.1504)	40 (88.2)	1PH7 103 - . . . F . . . . ■■■■	14	6SE7 021 - 4 E P60	
0.77	9.3	0.875	60.0	0.029 (0.2566)	65 (143.3)	1PH7 105 - . . . F . . . . ■■■■	20.5	6SE7 022 - 1 E P60	
0.80	10.6	0.870	60.3	0.029 (0.2566)	65 (143.3)	1PH7 107 - . . . F . . . . ■■■■	27	6SE7 022 - 7 E P60	
<b>• Drive type:</b>		<b>• Vibration sev. grade:</b>		<b>• Shaft and flange accuracy:</b>					
Coupling and belt		R		R		B			
Coupling and belt		S		R		C			
Coupling and belt		SR		R		D			
Coupling and belt		N		N (only in connection with brake attachment)		K			
Increased max. speed <sup>5)</sup>		SR		R		L			
<b>• Direction of air flow:</b>		<b>• Shaft end:</b>							
DE → NDE		With keyway, half-key balancing				A			
NDE → DE <sup>7)</sup>		With keyway, half-key balancing				B			
DE → NDE		With keyway, full-key balancing				C			
NDE → DE <sup>7)</sup>		With keyway, full-key balancing				D			
DE → NDE		Without keyway				J			
NDE → DE <sup>7)</sup>		Without keyway				K			
<b>• Paint finish:</b>									
None						0			
None, flange and radial shaft sealing ring <sup>6)</sup>						2			
Anthracite gray, standard finish (RAL 7016)						3			
Anthracite gray, standard finish (RAL 7016), flange and radial shaft sealing ring <sup>6)</sup>						5			
Anthracite gray, special finish (RAL 7016)						6			
Anthracite gray, special finish (RAL 7016), flange and radial shaft sealing ring <sup>6)</sup>						8			
<b>• Special models:</b>									
Please specify additional order code and any required plain text; see Page 3/3.						-Z			
Converter									
Inverter						E T			

- $n_1$ : Maximum permissible speed at constant power or speed where for  $P = P_{rated}$ , there is still a 30% power reserve up to the stall limit.
- $n_{S1}$ : Maximum permissible speed that is continuously permitted without speed duty cycles.
- $n_{max}$ : Maximum rotational speed. This speed may not be exceeded! Notice: Due to  $f_{max} < 5 \cdot f_{rated}$ , the maximum rotational speed is sometimes limited to smaller values.
- For model with brake: 12th position in ordering no. is "2" or "3"; 14th position is "K"; 15th position is "A", "B", "J" or "K"; 16th position "0", "3" or "6".
- Max. permissible rotational speed (see also Part 7)  
Shaft height 100: 12000 rpm, 132: 10000 rpm, 160: 8000 rpm, only with keyless shaft (15th position is "J" or "K")
- Model prepared for ZF gearbox attachment: 12th data position is "2" or "3"; 13th position is "0"; 14th position is "B", 15th position is "C" or "D"; 16th position is "2", "5" or "8". Stagnant fluids are not permitted at the shaft exit.
- Preferred air flow direction in contaminated environments.

# Servo Motors for SIMOVERT MASTERDRIVES

## Asynchronous Servo Motors

### 1PH7 Motors

#### Selection and Ordering Data with SIMOVERT MASTERDRIVES Vector Control (continued)

Rated Rotational Speed	Shaft Height	Rated Output	Rated Torque	Rated Current	Rated Voltage	Speed during Field Weakening <sup>1)</sup>	Max. Permissible Continuous Speed <sup>2)</sup>	Max. Speed <sup>3)</sup>	1PH7 Asynchronous Motors
$n_{rated}$		$P_{rated}$	$M_{rated}$	$I_{rated}$	$V_{rated}$	$n_1$	$n_{S1}$	$n_{max}$	Order No.
rpm	SH	kW (HP)	Nm (lb <sub>f</sub> -ft)	A	V	rpm	rpm	rpm	
<b>Supply voltage 3-ph. AC 400 V for SIMOVERT MASTERDRIVES Vector Control</b>									
<b>1750</b>	132	13 (17.43)	71 (52.4)	24	398	3300	4500	8000	<b>1PH7 131</b> – ■ ■ F ■ ■ – ■ ...
		17.5 (23.46)	96 (70.8)	34	398	3400	4500	8000	<b>1PH7 133</b> – ■ ■ F ■ ■ – ■ ...
		21.5 (28.82)	117 (86.3)	42	398	3800	4500	8000	<b>1PH7 135</b> – ■ ■ F ■ ■ – ■ ...
		25 (33.51)	136 (100.3)	56	357	4000	4500	8000	<b>1PH7 137</b> – ■ ■ F ■ ■ – ■ ...
	160	34 (45.58)	186 (137.2)	72	364	4000	3700	6500	<b>1PH7 163</b> – ■ ■ F ■ ■ – ■ ...
		41 (54.96)	224 (165.2)	79	398	2800	3700	6500	<b>1PH7 167</b> – ■ ■ F ■ ■ – ■ ...
<b>2300</b>	100	7.5 (10.05)	31 (22.9)	17	388	5400	5500	9000	<b>1PH7 103</b> – ■ ■ G ■ ■ – ■ ...
		12 (16.09)	50 (36.9)	26	400	5400	5500	9000	<b>1PH7 107</b> – ■ ■ G ■ ■ – ■ ...
	132	22.5 (30.16)	93 (68.6)	45	398	4000	4500	8000	<b>1PH7 133</b> – ■ ■ G ■ ■ – ■ ...
		29 (38.87)	120 (88.5)	56	398	4000	4500	8000	<b>1PH7 137</b> – ■ ■ G ■ ■ – ■ ...
	160	38 (50.94)	158 (116.5)	80	374	3000	3700	6500	<b>1PH7 163</b> – ■ ■ G ■ ■ – ■ ...
		44 (58.98)	183 (135)	85	398	3000	3700	6500	<b>1PH7 167</b> – ■ ■ G ■ ■ – ■ ...

**• Separate fan:**

- With separate fan
- Without separate fan, for pipe connection
- With separate fan, but with metric cable entries in accordance with EN 50262
- Without separate fan, for pipe connection, but with metric cable entries in accordance with EN 50262

2  
6  
7  
8

**• Encoder:**

- Without encoder
- Incremental encoder HTL (1,024 pulses/revolution)
- Incremental encoder HTL (2,048 pulses/revolution)

A  
H  
J

**• Terminal box arrangement/direction of cable entry (drive-end view):**

- On top/from right
- On top/from non-drive end
- On top/from left

0  
2  
3

**• Construction type:**

- IM B3 (IM V5, IM V6)
- IM B5 (IM V1, IM V3) available only for shaft height 100 and 132
- IM B35 (IM V15, IM V36)

0  
2  
3

**• Holding brake with emergency stop function:<sup>4)</sup>**

- Without brake
- Brake connection voltage: **230 V AC, 50 to 60 Hz**
- With brake
- With brake (brake includes microswitch)
- With brake (brake includes manual release)
- With brake (brake includes manual release and microswitch)
- Brake connection voltage: **24 V DC**
- With brake
- With brake (brake includes microswitch)
- With brake (brake includes manual release)
- With brake (brake includes manual release and microswitch)

0  
1  
2  
3  
4  
5  
6  
7  
8

For order number supplements for drive type, direction of air flow, and paint finish (positions 14 through 16 of the order no.), see page 3/7.



# Servo Motors for SIMOVERT MASTERDRIVES

## Asynchronous Servo Motors

1PH7 Motors

3

### Selection and Ordering Data with SIMOVERT MASTERDRIVES Vector Control (continued)

Power Factor	Magnetizing Current $I_{\mu}$ A	Rated Efficiency $\eta_{rated}$	Rated Frequency $f_{rated}$ Hz	Moment of inertia $J$ kgm <sup>2</sup> (lb <sub>f</sub> -in-s <sup>2</sup> )	Weight, approx. kg (lb)	1PH7 Asynchronous Motors		SIMOVERT MASTERDRIVES VC Inverter/Converter Rated Current	
						Order No.	$I_{rated}$ A	Order No.	
<b>Supply voltage 3-ph. AC 400 V for SIMOVERT MASTERDRIVES Vector Control</b>									
0.88	8.1	0.902	59.7	0.076 (0.6726)	90 (198.5)	1PH7 131 - . . . F . . . . ■■■■	27	6SE7 022 - 7 EP60	
0.85	14	0.900	59.7	0.076 (0.6726)	90 (198.5)	1PH7 133 - . . . F . . . . ■■■■	34	6SE7 023 - 4 P60	
0.86	16	0.906	59.5	0.109 (0.9646)	150 (330.8)	1PH7 135 - . . . F . . . . ■■■■	47	6SE7 024 - 7 D61	
0.85	23	0.902	59.5	0.109 (0.9646)	150 (330.8)	1PH7 137 - . . . F . . . . ■■■■	59	6SE7 026 - 0 D61	
0.86	28	0.915	59.2	0.185 (1.6372)	175 (385.9)	1PH7 163 - . . . F . . . . ■■■■	72	6SE7 027 - 2 D61	
0.86	30	0.920	59.2	0.228 (2.0178)	210 (463.1)	1PH7 167 - . . . F . . . . ■■■■	92	6SE7 031 - 0 E60	
0.79	8.2	0.866	78.8	0.017 (0.1504)	40 (88.2)	1PH7 103 - . . . G . . . . ■■■■	20.5	6SE7 022 - 1 EP60	
0.80	12	0.878	78.7	0.029 (0.2566)	65 (143.3)	1PH7 107 - . . . G . . . . ■■■■	27	6SE7 022 - 7 EP60	
0.86	17	0.900	78.0	0.076 (0.6726)	90 (198.5)	1PH7 133 - . . . G . . . . ■■■■	47	6SE7 024 - 7 D61	
0.87	21	0.903	77.8	0.109 (0.9646)	150 (330.8)	1PH7 137 - . . . G . . . . ■■■■	59	6SE7 026 - 0 D61	
0.83	36	0.900	77.3	0.185 (1.6372)	175 (385.9)	1PH7 163 - . . . G . . . . ■■■■	92	6SE7 031 - 0 E60	
0.84	40	0.911	77.4	0.228 (2.0178)	210 (463.1)	1PH7 167 - . . . G . . . . ■■■■	92	6SE7 031 - 0 E60	
<ul style="list-style-type: none"> <li><b>Drive type:</b> <ul style="list-style-type: none"> <li>Coupling and belt R</li> <li>Coupling and belt S</li> <li>Coupling and belt SR</li> <li>Coupling and belt N</li> <li>Increased max. speed<sup>5)</sup> SR</li> </ul> </li> <li><b>Vibration sev. grade:</b> <ul style="list-style-type: none"> <li>R</li> <li>R</li> <li>R</li> <li>N (only in connection with brake attachment)</li> <li>R</li> </ul> </li> <li><b>Shaft and flange accuracy:</b> <ul style="list-style-type: none"> <li>R</li> <li>R</li> <li>R</li> <li>N (only in connection with brake attachment)</li> <li>R</li> </ul> </li> </ul>						B			
<ul style="list-style-type: none"> <li><b>Direction of air flow:</b> <ul style="list-style-type: none"> <li>DE → NDE</li> <li>NDE → DE<sup>7)</sup></li> <li>DE → NDE</li> <li>NDE → DE<sup>7)</sup></li> <li>DE → NDE</li> <li>NDE → DE<sup>7)</sup></li> </ul> </li> <li><b>Shaft end:</b> <ul style="list-style-type: none"> <li>With keyway, half-key balancing</li> <li>With keyway, half-key balancing</li> <li>With keyway, full-key balancing</li> <li>With keyway, full-key balancing</li> <li>Without keyway</li> <li>Without keyway</li> </ul> </li> </ul>									A B C D J K
<ul style="list-style-type: none"> <li><b>Paint finish:</b> <ul style="list-style-type: none"> <li>None</li> <li>None, flange and radial shaft sealing ring<sup>6)</sup></li> <li>Anthracite gray, standard finish (RAL 7016)</li> <li>Anthracite gray, standard finish (RAL 7016), flange and radial shaft sealing ring<sup>6)</sup></li> <li>Anthracite gray, special finish (RAL 7016)</li> <li>Anthracite gray, special finish (RAL 7016), flange and radial shaft sealing ring<sup>6)</sup></li> </ul> </li> </ul>									0 2 3 5 6 8
<ul style="list-style-type: none"> <li><b>Special models:</b> <ul style="list-style-type: none"> <li>Please specify additional order code and any required plain text; see Page 3/3.</li> </ul> </li> </ul>									-Z
<ul style="list-style-type: none"> <li>Converter</li> <li>Inverter</li> </ul>									E T

- $n_1$ : Maximum permissible speed at constant power or speed where for  $P = P_{rated}$ , there is still a 30% power reserve up to the stall limit.
- $n_{S1}$ : Maximum permissible speed that is continuously permitted without speed duty cycles.
- $n_{max}$ : Maximum rotational speed. This speed may not be exceeded! Notice: Due to  $f_{max} < 5 \cdot f_{rated}$ , the maximum rotational speed is sometimes limited to smaller values.
- For model with brake: 12th position in ordering no. is "2" or "3"; 14th position is "K"; 15th position is "A", "B", "J" or "K"; 16th position "0", "3" or "6".
- Max. permissible rotational speed (see also Part 7)  
Shaft height 100: 12000 rpm, 132: 10000 rpm, 160: 8000 rpm, only with keyless shaft (15th position is "J" or "K")
- Model prepared for ZF gearbox attachment: 12th data position is "2" or "3"; 13th position is "0"; 14th position is "B", 15th position is "C" or "D"; 16th position is "2", "5" or "8". Stagnant fluids are not permitted at the shaft exit.
- Preferred air flow direction in contaminated environments.

# Servo Motors for SIMOVERT MASTERDRIVES

## Asynchronous Servo Motors

### 1PH7 Motors

#### Selection and Ordering Data with SIMOVERT MASTERDRIVES Vector Control

Rated Rotational Speed	Shaft Height	Rated Output	Rated Torque	Rated Current	Rated Voltage	Speed during Field Weakening <sup>1)</sup>	Max. Permissible Continuous Speed <sup>2)</sup>	Max. Speed <sup>3)</sup>	1PH7 Asynchronous Motors
$n_{rated}$		$P_{rated}$	$M_{rated}$	$I_{rated}$	$V_{rated}$	$n_1$	$n_{S1}$	$n_{max}$	Order No.
rpm	SH	kW (HP)	Nm (lb <sub>f</sub> -ft)	A	V	rpm	rpm	rpm	
<b>Supply voltage 3-ph. AC 400 V for SIMOVERT MASTERDRIVES Vector Control</b>									
<b>400</b>	180	16.3 (21.85)	390 (287.7)	51	271	2000	2000	2000	<b>1PH7 184</b> - ■ ■ B ■ ■ - ■ ...
		21.2 (28.42)	505 (372.5)	67	268	2000	2000	2000	<b>1PH7 186</b> - ■ ■ B ■ ■ - ■ ...
	225	30.4 (40.75)	725 (534.8)	88	268	2000	2000	2000	<b>1PH7 224</b> - ■ ■ B ■ ■ - ■ ...
		39.2 (52.55)	935 (689.7)	114	264	2000	2000	2000	<b>1PH7 226</b> - ■ ■ B ■ ■ - ■ ...
		48 (64.34)	1145 (844.6)	136	272	2000	2000	2000	<b>1PH7 228</b> - ■ ■ B ■ ■ - ■ ...
<b>1150</b>	180	44 (58.98)	366 (270)	89	383	3100	3500 <sup>4)</sup>	5000	<b>1PH7 184</b> - ■ ■ D ■ ■ - ■ ...
		58 (77.75)	482 (355.5)	116	390	3300	3500 <sup>4)</sup>	5000	<b>1PH7 186</b> - ■ ■ D ■ ■ - ■ ...
	225	81 (108.58)	670 (494.2)	160	385	2900	3100 <sup>4)</sup>	4500	<b>1PH7 224</b> - ■ ■ D ■ ■ - ■ ...
		105 (140.75)	870 (641.7)	197	390	2900	3100 <sup>4)</sup>	4500	<b>1PH7 226</b> - ■ ■ D ■ ■ - ■ ...
		129 (172.92)	1070 (789.2)	238	390	2900	3100 <sup>4)</sup>	4500 <sup>4)</sup>	<b>1PH7 228</b> - ■ ■ D ■ ■ - ■ ...

**• Separate fan:**

- With separate fan
- Without separate fan, for pipe connection
- With separate fan, but with metric cable entries in accordance with EN 50262
- Without separate fan, for pipe connection, but with metric cable entries in accordance with EN 50262

2  
6  
7  
8

**• Encoder:**

- Without encoder
- Incremental encoder HTL (1,024 pulses/revolution)
- Incremental encoder HTL (2,048 pulses/revolution)

A  
H  
J

**• Terminal box arrangement/direction of cable entry (drive-end view):**

- On top/from right
- On top/from drive end
- On top/from non-drive end
- On top/from left

0  
1  
2  
3

**• Construction type:**

- IM B3
  - IM B3
  - IM B35 (only for 1PH7 184 with flange A 400)
  - IM B35 (only for 1PH7 184 with flange A 450)
  - IM B35 (for 1PH7 186 with flange A 450 and 1PH7 22. with flange A 550)
  - IM B35 (only for 1PH7 184 with flange A 400)
  - IM B35 (only for 1PH7 184 with flange A 450)
  - IM B35 (for 1PH7 186 with flange A 450 and 1PH7 22. with flange A 550)
- Hoisting concept for other construction types (IM B6, IM B7, IM B8, IM V5, IM V6)
- Hoisting concept for other construction types (IM V15, IM V36)
- Hoisting concept for other construction types (IM V15, IM V36)
- Hoisting concept for other construction types (IM V15, IM V36)

0  
1  
3  
3  
5  
6  
5

**• Holding brake with emergency stop function (suitable for IM B3 coupling drive)<sup>5)</sup>:**

- Without brake
- With brake (brake includes emergency release screws and microswitch)
- With brake (brake includes manual release and microswitch)

0  
2  
4

For order number supplements for drive type, direction of air flow, and paint finish (positions 14 through 16 of the order no.), see page 3/9.

3

# Servo Motors for SIMOVERT MASTERDRIVES

## Asynchronous Servo Motors

1PH7 Motors

3

### Selection and Ordering Data with SIMOVERT MASTERDRIVES Vector Control

Power Factor $\cos \varphi$	Magnetizing Current $I_{\mu}$ A	Rated Efficiency $\eta_{rated}$	Rated Frequency $f_{rated}$ Hz	Moment of inertia $J$ kgm <sup>2</sup> (lb <sub>f</sub> -in-s <sup>2</sup> )	Weight, approx. kg (lb)	1PH7 Asynchronous Motors		SIMOVERT MASTERDRIVES VC Inverter/Converter Rated Current	
						Order No.	$I_{rated}$ A	Order No.	
<b>Supply voltage 3-ph. AC 400 V for SIMOVERT MASTERDRIVES Vector Control</b>									
0.84	26	0.830	14.2	0.503 (4.4545)	370 (815.8)	1PH7 184 - . . . B . . . . ■■■■	59	6SE7 026 - 0 ■ D61	
0.81	38.5	0.845	14.0	0.666 (5.894)	440 (970.2)	1PH7 186 - . . . B . . . . ■■■■	72	6SE7 027 - 2 ■ D61	
0.87	36.5	0.864	14.0	1.479 (13.0889)	630 (1389.2)	1PH7 224 - . . . B . . . . ■■■■	92	6SE7 031 - 0 ■ E60	
0.86	49	0.880	14.0	1.930 (17.0802)	750 (1653.8)	1PH7 226 - . . . B . . . . ■■■■	124	6SE7 031 - 2 ■ F60	
0.85	60.5	0.888	13.9	2.326 (20.5848)	860 (1896.3)	1PH7 228 - . . . B . . . . ■■■■	146	6SE7 031 - 5 ■ F60	
0.82	42	0.920	39.2	0.503 (4.4545)	370 (815.8)	1PH7 184 - . . . D . . . . ■■■■	92	6SE7 031 - 0 ■ E60	
0.81	58	0.925	39.1	0.666 (5.894)	440 (970.2)	1PH7 186 - . . . D . . . . ■■■■	124	6SE7 031 - 2 ■ F60	
0.81	79	0.938	38.9	1.479 (13.0889)	630 (1389.2)	1PH7 224 - . . . D . . . . ■■■■	186	6SE7 031 - 8 ■ F60	
0.84	87.5	0.941	38.9	1.930 (17.0802)	750 (1653.8)	1PH7 226 - . . . D . . . . ■■■■	210	6SE7 032 - 1 ■ G60	
0.85	98	0.943	38.9	2.326 (20.5848)	860 (1896.3)	1PH7 228 - . . . D . . . . ■■■■	260	6SE7 032 - 6 ■ G60	
<ul style="list-style-type: none"> <li><b>Drive type:</b> <ul style="list-style-type: none"> <li>Coupling R</li> <li>Coupling R</li> <li>Coupling S</li> <li>Coupling SR</li> <li>Belt R</li> <li>Belt R</li> <li>Increased cantilever forces R</li> <li>Increased cantilever forces R</li> <li>Increased maximum speed<sup>6)</sup> S</li> </ul> </li> <li><b>Vibration sev. grade:</b> <ul style="list-style-type: none"> <li>R</li> <li>R</li> <li>R</li> <li>R</li> <li>N</li> <li>R</li> <li>N</li> <li>R</li> <li>S</li> </ul> </li> <li><b>Shaft and flange accuracy:</b> <ul style="list-style-type: none"> <li>N</li> <li>R</li> <li>R</li> <li>R</li> <li>N</li> <li>R</li> <li>N</li> <li>R</li> <li>R</li> </ul> </li> </ul>						A B C D E F G H J			
<ul style="list-style-type: none"> <li><b>Direction of air flow:</b> <ul style="list-style-type: none"> <li>DE → NDE</li> <li>NDE → DE<sup>8)</sup></li> <li>DE → NDE</li> <li>NDE → DE<sup>8)</sup></li> <li>DE → NDE</li> <li>NDE → DE<sup>8)</sup></li> </ul> </li> <li><b>Shaft end:</b> <ul style="list-style-type: none"> <li>With keyway, half-key balancing</li> <li>With keyway, half-key balancing</li> <li>With keyway, full-key balancing</li> <li>With keyway, full-key balancing</li> <li>Without keyway</li> <li>Without keyway</li> </ul> </li> </ul>						A B C D J K			
<ul style="list-style-type: none"> <li><b>Paint finish:</b> <ul style="list-style-type: none"> <li>Primed</li> <li>Primed, prepared for ZF gearbox attachment<sup>7)</sup></li> <li>Anthracite gray, standard finish (RAL 7016)</li> <li>Anthracite gray, standard finish (RAL 7016), prepared for ZF gearbox attachment<sup>7)</sup></li> <li>Anthracite gray, special finish (RAL 7016)</li> <li>Anthracite gray, special finish (RAL 7016), prepared for ZF gearbox attachment<sup>7)</sup></li> </ul> </li> </ul>						0 2 3 5 6 8			
<ul style="list-style-type: none"> <li><b>Special models:</b> <ul style="list-style-type: none"> <li>Please specify additional order code and any required plain text; see Page 3/3.</li> </ul> </li> </ul>						-Z			
<ul style="list-style-type: none"> <li>Converter</li> <li>Inverter</li> </ul>								E T	

- $n_1$ : Maximum permissible speed at constant power or speed where for  $P = P_{rated}$ , there is still a 30% power reserve up to the stall limit.
- $n_{S1}$ : Maximum permissible speed that is continuously permitted without speed duty cycles.
- $n_{max}$ : Maximum rotational speed. This speed may not be exceeded! Notice: Due to  $f_{max} < 5 \cdot f_{rated}$ , the maximum rotational speed is sometimes limited to smaller values.
- Rotational speed is reduced in the event of increased cantilever forces, see Part 7.
- For model with brake: 12th data position "0", 14th and 15th position "A", 16th position "0", "3" or "6".
- For shaft height 180  $n_{max} = 7000$  rpm, 1PH7 224  $n_{max} = 5500$  rpm, coupling drive only.
- Model prepared for ZF gearbox attachment: Only for types 1PH7 184, 186, and 224, 12th data position is "3" or "5", 13th is "0"; 14th is "B"; 15th is "C"; 16th is "2", "5" or "8". Stagnant fluids are not permitted at the shaft exit.
- Preferred air flow direction in contaminated environments.

# Servo Motors for SIMOVERT MASTERDRIVES

## Asynchronous Servo Motors

### 1PH7 Motors

#### Selection and Ordering Data with SIMOVERT MASTERDRIVES Vector Control (continued)

Rated Rotational Speed	Shaft Height	Rated Output	Rated Torque	Rated Current	Rated Voltage	Speed during Field Weakening <sup>1)</sup>	Max. Permissible Continuous Speed <sup>2)</sup>	Max. Speed <sup>3)</sup>	1PH7 Asynchronous Motors
$n_{rated}$		$P_{rated}$	$M_{rated}$	$I_{rated}$	$V_{rated}$	$n_1$	$n_{S1}$	$n_{max}$	Order No.
rpm	SH	kW (HP)	Nm (lb <sub>f</sub> -ft)	A	V	rpm	rpm	rpm	
<b>Supply voltage 3-ph. AC 400 V for SIMOVERT MASTERDRIVES Vector Control</b>									
<b>1750</b>	180	60 (80.43)	327 (241.2)	120	388	5000	3500 <sup>4)</sup>	5000	<b>1PH7 184 - ■ ■ F ■ ■ - ■ . . .</b>
		85 (113.94)	465 (343)	169	385	5000	3500 <sup>4)</sup>	5000	<b>1PH7 186 - ■ ■ F ■ ■ - ■ . . .</b>
	225	110 (147.45)	600 (442.6)	203	395	2900	3100 <sup>4)</sup>	4500	<b>1PH7 224 - ■ ■ U ■ ■ - ■ . . .</b>
		135 (180.97)	737 (543.6)	254	395	2900	3100 <sup>4)</sup>	4500	<b>1PH7 226 - ■ ■ F ■ ■ - ■ . . .</b>
		179 (239.95)	975 (719.2)	342	395	2900	3100 <sup>4)</sup>	4500 <sup>4)</sup>	<b>1PH7 228 - ■ ■ F ■ ■ - ■ . . .</b>
<b>2900</b>	180	81 (108.58)	265 (195.5)	158	395	5000	3500 <sup>4)</sup>	5000	<b>1PH7 184 - ■ ■ L ■ ■ - ■ . . .</b>
		101 (135.39)	333 (245.6)	206	385	5000	3500 <sup>4)</sup>	5000	<b>1PH7 186 - ■ ■ L ■ ■ - ■ . . .</b>
	225	149 (199.73)	490 (361.4)	274	395	3500	3100 <sup>4)</sup>	4500	<b>1PH7 224 - ■ ■ L ■ ■ - ■ . . .</b>
		185 (247.99)	610 (450)	348	390	3500	3100 <sup>4)</sup>	4500	<b>1PH7 226 - ■ ■ L ■ ■ - ■ . . .</b>
		215 (288.2)	708 (522.2)	402	395	3500	3100 <sup>4)</sup>	4500 <sup>4)</sup>	<b>1PH7 228 - ■ ■ L ■ ■ - ■ . . .</b>

**• Separate fan:**

- With separate fan
- Without separate fan, for pipe connection
- With separate fan, but with metric cable entries in accordance with EN 50262
- Without separate fan, for pipe connection, but with metric cable entries in accordance with EN 50262

2  
6  
7  
8

**• Encoder:**

- Without encoder
- Incremental encoder HTL (1,024 pulses/revolution)
- Incremental encoder HTL (2,048 pulses/revolution)

A  
H  
J

**• Terminal box arrangement/direction of cable entry (drive-end view):**

- On top/from right
- On top/from drive end
- On top/from non-drive end
- On top/from left

0  
1  
2  
3

**• Construction type:**

- IM B3
  - IM B3
  - IM B35 (only for 1PH7 184 with flange A 400)
  - IM B35 (only for 1PH7 184 with flange A 450)
  - IM B35 (for 1PH7 186 with flange A 450 and 1PH7 22. with flange A 550)
  - IM B35 (only for 1PH7 184 with flange A 400)
  - IM B35 (only for 1PH7 184 with flange A 450)
  - IM B35 (for 1PH7 186 with flange A 450 and 1PH7 22. with flange A 550)
- Hoisting concept for other construction types (IM B6, IM B7, IM B8, IM V5, IM V6)
- Hoisting concept for other construction types (IM V15, IM V36)
- Hoisting concept for other construction types (IM V15, IM V36)
- Hoisting concept for other construction types (IM V15, IM V36)

0  
1  
3  
3  
5  
6  
5

**• Holding brake with emergency stop function (suitable for IM B3 coupling drive)<sup>5)</sup>:**

- Without brake
- With brake (brake includes emergency release screws and microswitch)
- With brake (brake includes manual release and microswitch)

0  
2  
4

For order number supplements for drive type, direction of air flow, and paint finish (positions 14 through 16 of the order no.), see page 3/11.

# Servo Motors for SIMOVERT MASTERDRIVES

## Asynchronous Servo Motors

1PH7 Motors

3

### Selection and Ordering Data with SIMOVERT MASTERDRIVES Vector Control (continued)

Power Factor $\cos \varphi$	Magnetizing Current $I_{\mu}$ A	Rated Efficiency $\eta_{rated}$	Rated Frequency $f_{rated}$ Hz	Moment of inertia $J$ kgm <sup>2</sup> (lb <sub>f</sub> -in-s <sup>2</sup> )	Weight, approx. kg (lb)	1PH7 Asynchronous Motors Order No.	SIMOVERT MASTERDRIVES VC Inverter/Converter Rated Current $I_{rated}$ A	Order No.
	<b>Supply voltage 3-ph. AC 400 V for SIMOVERT MASTERDRIVES Vector Control</b>							
0.78	64	0.934	59.0	0.503 (4.4545)	370 (815.8)	1PH7 184 - . . . F . . . . ■■■■	124	6SE7 031 - 2 ■ F60
0.80	84	0.940	59.0	0.666 (5.894)	440 (970.2)	1PH7 186 - . . . F . . . . ■■■■	186	6SE7 031 - 8 ■ F60
0.84	88	0.944	58.9	1.479 (13.0889)	630 (1389.2)	1PH7 224 - . . . U . . . . ■■■■	210	6SE7 032 - 1 ■ G60
0.82	120	0.947	58.9	1.930 (17.0802)	750 (1653.8)	1PH7 226 - . . . F . . . . ■■■■	260	6SE7 032 - 6 ■ G60
0.81	169	0.948	58.8	2.326 (20.5848)	860 (1896.3)	1PH7 228 - . . . F . . . . ■■■■	370	6SE7 033 - 7 ■ G60
0.80	77	0.934	97.4	0.503 (4.4545)	370 (815.8)	1PH7 184 - . . . L . . . . ■■■■	186	6SE7 031 - 8 ■ F60
0.78	107	0.936	97.3	0.666 (5.894)	440 (970.2)	1PH7 186 - . . . L . . . . ■■■■	210	6SE7 032 - 1 ■ G60
0.84	115	0.946	97.3	1.479 (13.0889)	630 (1389.2)	1PH7 224 - . . . L . . . . ■■■■	315	6SE7 033 - 2 ■ G60
0.83	154	0.946	97.2	1.930 (17.0802)	750 (1653.8)	1PH7 226 - . . . L . . . . ■■■■	370	6SE7 033 - 7 ■ G60
0.82	186	0.946	97.2	2.326 (20.5848)	860 (1896.3)	1PH7 228 - . . . L . . . . ■■■■	510	6SE7 035 - 1 ■ K/J60
<ul style="list-style-type: none"> <li><b>Drive type:</b> <ul style="list-style-type: none"> <li>Coupling R</li> <li>Coupling R</li> <li>Coupling S</li> <li>Coupling SR</li> <li>Belt R</li> <li>Belt R</li> <li>Increased cantilever forces R</li> <li>Increased cantilever forces R</li> <li>Increased maximum speed<sup>6)</sup> S</li> </ul> </li> <li><b>Vibration sev. grade:</b> <ul style="list-style-type: none"> <li>R</li> <li>R</li> <li>R</li> <li>R</li> <li>N</li> <li>R</li> <li>N</li> <li>R</li> <li>S</li> </ul> </li> <li><b>Shaft and flange accuracy:</b> <ul style="list-style-type: none"> <li>N</li> <li>R</li> <li>R</li> <li>R</li> <li>N</li> <li>R</li> <li>N</li> <li>R</li> <li>R</li> </ul> </li> </ul>						A B C D E F G H J		
<ul style="list-style-type: none"> <li><b>Direction of air flow:</b> <ul style="list-style-type: none"> <li>DE → NDE</li> <li>NDE → DE<sup>8)</sup></li> <li>DE → NDE</li> <li>NDE → DE<sup>8)</sup></li> <li>DE → NDE</li> <li>NDE → DE<sup>8)</sup></li> </ul> </li> <li><b>Shaft end:</b> <ul style="list-style-type: none"> <li>With keyway, half-key balancing</li> <li>With keyway, half-key balancing</li> <li>With keyway, full-key balancing</li> <li>With keyway, full-key balancing</li> <li>Without keyway</li> <li>Without keyway</li> </ul> </li> </ul>						A B C D J K		
<ul style="list-style-type: none"> <li><b>Paint finish:</b> <ul style="list-style-type: none"> <li>Primed</li> <li>Primed, prepared for ZF gearbox attachment<sup>7)</sup></li> <li>Anthracite gray, standard finish (RAL 7016)</li> <li>Anthracite gray, standard finish (RAL 7016), prepared for ZF gearbox attachment<sup>7)</sup></li> <li>Anthracite gray, special finish (RAL 7016)</li> <li>Anthracite gray, special finish (RAL 7016), prepared for ZF gearbox attachment<sup>7)</sup></li> </ul> </li> </ul>						0 2 3 5 6 8		
<ul style="list-style-type: none"> <li><b>Special models:</b> <ul style="list-style-type: none"> <li>Please specify additional order code and any required plain text; see Page 3/3.</li> </ul> </li> </ul>						-Z		
<ul style="list-style-type: none"> <li>Converter</li> <li>Inverter</li> </ul>						E T		

- $n_1$ : Maximum permissible speed at constant power or speed where for  $P = P_{rated}$ , there is still a 30% power reserve up to the stall limit.
- $n_{S1}$ : Maximum permissible speed that is continuously permitted without speed duty cycles.
- $n_{max}$ : Maximum rotational speed. This speed may not be exceeded! Notice: Due to  $f_{max} < 5 \cdot f_{rated}$ , the maximum rotational speed is sometimes limited to smaller values.
- Rotational speed is reduced in the event of increased cantilever forces, see Part 7.
- For model with brake: 12th data position "0", 14th and 15th position "A", 16th position "0", "3" or "6".
- For shaft height 180  $n_{max} = 7000$  rpm, 1PH7 224  $n_{max} = 5500$  rpm, coupling drive only.
- Model prepared for ZF gearbox attachment: Only for types 1PH7 184, 186, and 224, 12th data position is "3" or "5", 13th is "0"; 14th is "B"; 15th is "C"; 16th is "2", "5" or "8". Stagnant fluids are not permitted at the shaft exit.
- Preferred air flow direction in contaminated environments.

# Servo Motors for SIMOVERT MASTERDRIVES

## Asynchronous Servo Motors

### 1PH7 Motors

#### Selection and Ordering Data with SIMOVERT MASTERDRIVES Vector Control

Rated Rotational Speed	Shaft Height	Rated Output	Rated Torque	Rated Current	Rated Voltage	Speed during Field Weakening <sup>1)</sup>	Max. Permissible Continuous Speed <sup>2)</sup>	Max. Speed <sup>3)</sup>	1PH7 Asynchronous Motors
$n_{rated}$	SH	$P_{rated}$	$M_{rated}$	$I_{rated}$	$V_{rated}$	$n_1$	$n_{S1}$	$n_{max}$	Order No.
rpm		kW (HP)	Nm (lb <sub>f</sub> -ft)	A	V	rpm	rpm	rpm	
<b>Supply voltage 3-ph. AC 400 V for SIMOVERT MASTERDRIVES Vector Control</b>									
500	280	80 (107.24)	1529 (1127.8)	144	400	1150	2200	2500	1PH7 284 - ■ ■ B ■ ■ - 0 ...
		100 (134.05)	1909 (1408.1)	180	400	1300	2200	2500	1PH7 286 - ■ ■ B ■ ■ - 0 ...
		130 (174.26)	2481 (1830)	233	400	1400	2200	2500	1PH7 288 - ■ ■ B ■ ■ - 0 ...
800	280	125 (167.56)	1492 (1100.5)	220	400	2200	2200	3300	1PH7 284 - ■ ■ C ■ ■ - 0 ...
		155 (207.77)	1850 (1364.6)	285	385	2200	2200	3300	1PH7 286 - ■ ■ C ■ ■ - 0 ...
		190 (254.69)	2268 (1672.9)	365	370	2200	2200	3300	1PH7 288 - ■ ■ C ■ ■ - 0 ...
1150	280	170 (227.88)	1414 (1043)	314	400	2200	2200	3300	1PH7 284 - ■ ■ D ■ ■ - 0 ...
		210 (281.5)	1745 (1287.1)	414	380	2200	2200	3300	1PH7 286 - ■ ■ D ■ ■ - 0 ...
		260 (348.53)	2160 (1593.2)	497	385	2200	2200	3300	1PH7 288 - ■ ■ D ■ ■ - 0 ...
1750	280	225 (301.61)	1228 (905.8)	393	400	2200	2200	3300	1PH7 284 - ■ ■ F ■ ■ - 0 ...
		270 (361.93)	1474 (1087.2)	466	400	2200	2200	3300	1PH7 286 - ■ ■ F ■ ■ - 0 ...
		340 (455.76)	1856 (1369)	586	400	2200	2200	3300	1PH7 288 - ■ ■ F ■ ■ - 0 ...

- **Separate fan:<sup>4)</sup>**
  - With separate fan, non-drive end on top, air flow non-drive end to drive end
  - With separate fan, non-drive end on the right, air flow non-drive end to drive end
  - With separate fan, non-drive end on the left, air flow non-drive end to drive end
  - With separate fan, drive end on top, air flow drive end to non-drive end
  - With separate fan, drive end on the right, air flow drive end to non-drive end
  - With separate fan, drive end on the left, air flow drive end to non-drive end
  - Without separate fan, for simple pipe connection on non-drive end on the right

0  
1  
2  
3  
4  
5  
6

- **Encoder:**
  - Without encoder
  - Incremental encoder HTL (1,024 pulses/revolution)
  - Incremental encoder HTL (2,048 pulses/revolution)

A  
H  
J

- **Terminal box/direction of cable entry (drive-end view):<sup>4)</sup>**
  - Terminal box non-drive side on right/cable entry on bottom/encoder connector on drive side
  - Terminal box non-drive side on left/cable entry on bottom/encoder connector on drive side
  - Terminal box non-drive side on top/cable entry on right/encoder connector on drive side
  - Terminal box drive side on top/cable entry on right/encoder connector on non-drive side

0  
1  
2  
5

- **Construction type:<sup>4)</sup>**
  - IM B3
  - IM V5 (can be converted later to IM V6)
  - IM B35 (with flange A 660)
  - IM V15 (with flange A 660; can be converted later to IM V36)

0  
1  
3  
5

For order number supplements for drive type, direction of air flow, and paint finish (positions 14 through 16 of the order no.), see page 3/13.

3

# Servo Motors for SIMOVERT MASTERDRIVES

## Asynchronous Servo Motors

1PH7 Motors

### Selection and Ordering Data with SIMOVERT MASTERDRIVES Vector Control

Power Factor	Magnetizing Current $I_{\mu}$ A	Rated Efficiency $\eta_{rated}$	Rated Frequency $f_{rated}$ Hz	Moment of inertia $J$ kgm <sup>2</sup> (lb <sub>f</sub> -in-s <sup>2</sup> )	Weight, approx. kg (lb)	1PH7 Asynchronous Motors	SIMOVERT MASTERDRIVES VC Inverter/Converter Rated Current	
						Order No.	$I_{rated}$ A	Order No.
<b>Supply voltage 3-ph. AC 400 V for SIMOVERT MASTERDRIVES Vector Control</b>								
0.87	60	0.922	17.0	4.2 (37.1694)	1300 (2866.5)	1PH7 284 - . . B . . - 0 ■ ■ ■ ■	146	6SE7 031 - 5 ■ F60
0.86	78	0.930	17.0	5.2 (46.0192)	1500 (3307.5)	1PH7 286 - . . B . . - 0 ■ ■ ■ ■	186	6SE7 031 - 8 ■ F60
0.87	100	0.933	17.0	6.3 (55.7541)	1700 (3748.5)	1PH7 288 - . . B . . - 0 ■ ■ ■ ■	260	6SE7 032 - 6 ■ G60
0.86	95	0.944	27.0	4.2 (37.1694)	1300 (2866.5)	1PH7 284 - . . C . . - 0 ■ ■ ■ ■	260	6SE7 032 - 6 ■ G60
0.85	135	0.948	27.0	5.2 (46.0192)	1500 (3307.5)	1PH7 286 - . . C . . - 0 ■ ■ ■ ■	370	6SE7 033 - 7 ■ G60
0.84	170	0.951	27.0	6.3 (55.7541)	1700 (3748.5)	1PH7 288 - . . C . . - 0 ■ ■ ■ ■	370	6SE7 033 - 7 ■ G60
0.82	158	0.956	38.6	4.2 (37.1694)	1300 (2866.5)	1PH7 284 - . . D . . - 0 ■ ■ ■ ■	315	6SE7 033 - 2 ■ G60
0.81	218	0.958	38.6	5.2 (46.0192)	1500 (3307.5)	1PH7 286 - . . D . . - 0 ■ ■ ■ ■	510	6SE7 035 - 1 ■ K/J60
0.82	252	0.960	38.6	6.3 (55.7541)	1700 (3748.5)	1PH7 288 - . . D . . - 0 ■ ■ ■ ■	510	6SE7 035 - 1 ■ K/J60
0.86	163	0.962	58.7	4.2 (37.1694)	1300 (2866.5)	1PH7 284 - . . F . . - 0 ■ ■ ■ ■	510	6SE7 035 - 1 ■ K/J60
0.87	184	0.963	58.7	5.2 (46.0192)	1500 (3307.5)	1PH7 286 - . . F . . - 0 ■ ■ ■ ■	510	6SE7 035 - 1 ■ K/J60
0.87	234	0.965	58.7	6.3 (55.7541)	1700 (3748.5)	1PH7 288 - . . F . . - 0 ■ ■ ■ ■	590	6SE7 036 - 0 ■ K/J60
<ul style="list-style-type: none"> <li>• <b>Drive type:</b><sup>4)</sup> Coupling N Coupling R Belt/increased cantilever forces N Belt/increased cantilever forces R</li> <li>• <b>Vibration sev. grade:</b> N R N R</li> <li>• <b>Shaft and flange accuracy:</b> N R N R</li> </ul>						A		
<ul style="list-style-type: none"> <li>• <b>Shaft end:</b> With keyway, half-key balancing With keyway, full-key balancing Without keyway</li> </ul>						B		
<ul style="list-style-type: none"> <li>• <b>Paint finish:</b> Primed Anthracite gray, standard finish (RAL 7016) Anthracite gray, special finish (RAL 7016)</li> </ul>						E		
<ul style="list-style-type: none"> <li>• <b>Special models:</b> Please specify additional order code and any required plain text; see Page 3/3.</li> </ul>						F		
Converter						A		
Inverter						C		
						J		
						0		
						3		
						6		
						-Z		
						E		
						T		

1)  $n_1$ : Maximum permissible speed at constant power or speed where for  $P = P_{rated}$ , there is still a 30% power reserve up to the stall limit.  
2)  $n_{S1}$ : Maximum permissible speed that is continuously permitted without speed duty cycles.

3)  $n_{max}$ : Maximum rotational speed. This speed may not be exceeded!  
Notice: Due to  $f_{max} < 5 \cdot f_{rated}$ , the maximum rotational speed is sometimes limited to smaller values.  
4) For possible combinations, refer to page 3/42.



# Servo Motors for SIMOVERT MASTERDRIVES

## Asynchronous Servo Motors

### 1PH7 Motors

#### Selection and Ordering Data with SIMOVERT MASTERDRIVES Vector Control

Rated Rotational Speed	Shaft Height	Rated Output	Rated Torque	Rated Current	Rated Voltage	Speed during Field Weakening <sup>1)</sup>	Max. Permissible Continuous Speed <sup>2)</sup>	Max. Speed <sup>3)</sup>	1PH7 Asynchronous Motors
$n_{rated}$	SH	$P_{rated}$	$M_{rated}$	$I_{rated}$	$V_{rated}$	$n_1$	$n_{S1}$	$n_{max}$	Order No.
rpm		kW (HP)	Nm (lb <sub>f</sub> -ft)	A	V	rpm	rpm	rpm	
<b>Supply voltage 3-ph. AC 480 V for SIMOVERT MASTERDRIVES Vector Control</b>									
<b>500</b>	160	12 (16.09)	230 (169.6)	30	340	2100	2500	2500	<b>1PH7 163</b> – ■ ■ B ■ ■ – ■ ...
		16 (21.45)	306 (225.7)	35	350	1700	2500	2500	<b>1PH7 167</b> – ■ ■ B ■ ■ – ■ ...
<b>1350</b>	100	4.7 (6.3)	33 (24.3)	9.5	433	3000	5500	6750	<b>1PH7 103</b> – ■ ■ D ■ ■ – ■ ...
		8.0 (10.72)	57 (42)	17	405	3800	5500	6750	<b>1PH7 107</b> – ■ ■ D ■ ■ – ■ ...
	132	15 (20.11)	106 (78.19)	30	433	3100	4500	6750	<b>1PH7 133</b> – ■ ■ D ■ ■ – ■ ...
		22 (29.49)	156 (115.1)	42	416	3200	4500	6750	<b>1PH7 137</b> – ■ ■ D ■ ■ – ■ ...
	160	28 (37.53)	198 (146)	53	413	4100	3700	6500	<b>1PH7 163</b> – ■ ■ D ■ ■ – ■ ...
		34 (45.58)	241 (177.8)	67	400	4600	3700	6500	<b>1PH7 167</b> – ■ ■ D ■ ■ – ■ ...
<b>2000</b>	100	4.7 (6.3)	22 (16.2)	10	459	6000	5500	9000	<b>1PH7 101</b> – ■ ■ F ■ ■ – ■ ...
		7.0 (9.38)	33 (24.3)	13	459	3400	5500	9000	<b>1PH7 103</b> – ■ ■ F ■ ■ – ■ ...
		9.0 (12.06)	43 (31.7)	17.5	450	5000	5500	9000	<b>1PH7 105</b> – ■ ■ F ■ ■ – ■ ...
		11 (14.75)	53 (39.1)	23	433	5300	5500	9000	<b>1PH7 107</b> – ■ ■ F ■ ■ – ■ ...

#### • Separate fan:

- With separate fan
- Without separate fan, for pipe connection
- With separate fan, but with metric cable entries in accordance with EN 50262
- Without separate fan, for pipe connection, but with metric cable entries in accordance with EN 50262

2  
6  
7  
8

#### • Encoder:

- Without encoder
- Incremental encoder HTL (1,024 pulses/revolution)
- Incremental encoder HTL (2,048 pulses/revolution)

A  
H  
J

#### • Terminal box arrangement/direction of cable entry (drive-end view):

- On top/from right
- On top/from non-drive end
- On top/from left

0  
2  
3

#### • Construction type:

- IM B3 (IM V5, IM V6)
- IM B5 (IM V1, IM V3) available only for shaft height 100 and 132
- IM B35 (IM V15, IM V36)

0  
2  
3

#### • Holding brake with emergency stop function:<sup>4)</sup>

- Without brake
- Brake connection voltage: **230 V AC, 50 to 60 Hz**
- With brake
- With brake (brake includes microswitch)
- With brake (brake includes manual release)
- With brake (brake includes manual release and microswitch)
- Brake connection voltage: **24 V DC**
- With brake
- With brake (brake includes microswitch)
- With brake (brake includes manual release)
- With brake (brake includes manual release and microswitch)

0  
1  
2  
3  
4  
5  
6  
7  
8

For order number supplements for drive type, direction of air flow, and paint finish (positions 14 through 16 of the order no.), see page 3/15.

# Servo Motors for SIMOVERT MASTERDRIVES

## Asynchronous Servo Motors

1PH7 Motors

3

### Selection and Ordering Data with SIMOVERT MASTERDRIVES Vector Control

Power Factor $\cos \varphi$	Magnetizing Current $I_{\mu}$ A	Rated Efficiency $\eta_{rated}$	Rated Frequency $f_{rated}$ Hz	Moment of inertia $J$ kgm <sup>2</sup> (lb <sub>f</sub> -in-s <sup>2</sup> )	Weight, approx. kg (lb)	1PH7 Asynchronous Motors		SIMOVERT MASTERDRIVES VC Inverter/Converter Rated Current	
						Order No.		$I_{rated}$ A	Order No.
<b>Supply voltage 3-ph. AC 480 V for SIMOVERT MASTERDRIVES Vector Control</b>									
0.86	13	0.841	17.6	0.185 (1.6372)	175 (385.9)	1PH7 163 - . . . B . . . .	34	6SE7 023 - 4	P60
0.89	13	0.836	17.7	0.228 (2.0178)	210 (463.1)	1PH7 167 - . . . B . . . .	37.5	6SE7 023 - 8	D61
0.81	4.5	0.830	47.1	0.017 (0.1504)	40 (88.2)	1PH7 103 - . . . D . . . .	10	6SE7 021 - 0	P60
0.80	8.1	0.853	47.0	0.029 (0.2566)	65 (143.3)	1PH7 107 - . . . D . . . .	20.5	6SE7 022 - 1	EP60
0.84	12	0.887	46.4	0.076 (0.6726)	90 (198.5)	1PH7 133 - . . . D . . . .	34	6SE7 023 - 4	P60
0.85	17	0.895	46.3	0.109 (0.9646)	150 (330.8)	1PH7 137 - . . . D . . . .	47	6SE7 024 - 7	D61
0.83	24	0.911	45.8	0.185 (1.6372)	175 (385.9)	1PH7 163 - . . . D . . . .	59	6SE7 026 - 0	D61
0.83	34	0.910	45.8	0.228 (2.0178)	210 (463.1)	1PH7 167 - . . . D . . . .	72	6SE7 027 - 2	D61
0.72	6.0	0.862	68.2	0.017 (0.1504)	40 (88.2)	1PH7 101 - . . . F . . . .	10	6SE7 021 - 0	P60
0.82	5.6	0.860	69.1	0.017 (0.1504)	40 (88.2)	1PH7 103 - . . . F . . . .	14	6SE7 021 - 4	EP60
0.78	9.3	0.878	68.3	0.029 (0.2566)	65 (143.3)	1PH7 105 - . . . F . . . .	20.5	6SE7 022 - 1	EP60
0.79	10.8	0.876	68.6	0.029 (0.2566)	65 (143.3)	1PH7 107 - . . . F . . . .	27	6SE7 022 - 7	EP60
<b>• Drive type:</b> Coupling and belt R Coupling and belt S Coupling and belt SR Coupling and belt N Increased max. speed <sup>5)</sup> SR						<b>• Vibration sev. grade:</b> R R R N (only in connection with brake attachment) R		<b>• Shaft and flange accuracy:</b> B C D K L	
<b>• Direction of air flow:</b> DE → NDE NDE → DE <sup>7)</sup> DE → NDE NDE → DE <sup>7)</sup> DE → NDE NDE → DE <sup>7)</sup>						<b>• Shaft end:</b> With keyway, half-key balancing With keyway, half-key balancing With keyway, full-key balancing With keyway, full-key balancing Without keyway Without keyway		A B C D J K	
<b>• Paint finish:</b> None None, flange and radial shaft sealing ring <sup>6)</sup> Anthracite gray, standard finish (RAL 7016) Anthracite gray, standard finish (RAL 7016), flange and radial shaft sealing ring <sup>6)</sup> Anthracite gray, special finish (RAL 7016) Anthracite gray, special finish (RAL 7016), flange and radial shaft sealing ring <sup>6)</sup>						0 2 3 5 6 8			
<b>• Special models:</b> Please specify additional order code and any required plain text; see Page 3/3.						-Z			
Converter Inverter								E T	

- $n_1$ : Maximum permissible speed at constant power or speed where for  $P = P_{rated}$ , there is still a 30% power reserve up to the stall limit.
- $n_{S1}$ : Maximum permissible speed that is continuously permitted without speed duty cycles.
- $n_{max}$ : Maximum rotational speed. This speed may not be exceeded! Notice: Due to  $f_{max} < 5 \cdot f_{rated}$ , the maximum rotational speed is sometimes limited to smaller values.
- For model with brake: 12th position in ordering no. is "2" or "3"; 14th position is "K"; 15th position is "A", "B", "J" or "K"; 16th position "0", "3" or "6".
- Max. permissible rotational speed (see also Part 7)  
Shaft height 100: 12000 rpm, 132: 10000 rpm, 160: 8000 rpm, only with keyless shaft (15th position is "J" or "K")
- Model prepared for ZF gearbox attachment: 12th data position is "2" or "3"; 13th position is "0"; 14th position is "B", 15th position is "C" or "D"; 16th position is "2", "5" or "8". Stagnant fluids are not permitted at the shaft exit.
- Preferred air flow direction in contaminated environments.

# Servo Motors for SIMOVERT MASTERDRIVES

## Asynchronous Servo Motors

### 1PH7 Motors

#### Selection and Ordering Data with SIMOVERT MASTERDRIVES Vector Control (continued)

Rated Rotational Speed	Shaft Height	Rated Output	Rated Torque	Rated Current	Rated Voltage	Speed during Field Weakening <sup>1)</sup>	Max. Permissible Continuous Speed <sup>2)</sup>	Max. Speed <sup>3)</sup>	1PH7 Asynchronous Motors
$n_{rated}$	SH	$P_{rated}$	$M_{rated}$	$I_{rated}$	$V_{rated}$	$n_1$	$n_{S1}$	$n_{max}$	Order No.
rpm		kW (HP)	Nm (lb <sub>f</sub> -ft)	A	V	rpm	rpm	rpm	
<b>Supply voltage 3-ph. AC 480 V for SIMOVERT MASTERDRIVES Vector Control</b>									
<b>2000</b>	132	15 (20.11)	72 (53.1)	25	459	3900	4500	8000	<b>1PH7 131</b> - ■ ■ F ■ ■ - ■ ...
		20 (26.81)	96 (70.8)	34	459	4100	4500	8000	<b>1PH7 133</b> - ■ ■ F ■ ■ - ■ ...
		24 (32.17)	115 (84.8)	42	459	4700	4500	8000	<b>1PH7 135</b> - ■ ■ F ■ ■ - ■ ...
		28 (37.53)	134 (98.8)	55	402	4000	4500	8000	<b>1PH7 137</b> - ■ ■ F ■ ■ - ■ ...
	160	37 (49.6)	177 (130.6)	70	412	4000	3700	6500	<b>1PH7 163</b> - ■ ■ F ■ ■ - ■ ...
		45 (60.32)	215 (158.6)	76	459	3300	3700	6500	<b>1PH7 167</b> - ■ ■ F ■ ■ - ■ ...
<b>2650</b>	100	8.0 (10.72)	29 (21.4)	16.5	440	7000	5500	9000	<b>1PH7 103</b> - ■ ■ G ■ ■ - ■ ...
		13 (17.43)	47 (34.7)	24.5	459	6700	5500	9000	<b>1PH7 107</b> - ■ ■ G ■ ■ - ■ ...
	132	24 (32.17)	87 (64.2)	42	450	4000	4500	8000	<b>1PH7 133</b> - ■ ■ G ■ ■ - ■ ...
		30 (40.21)	108 (79.7)	52	450	4200	4500	8000	<b>1PH7 137</b> - ■ ■ G ■ ■ - ■ ...
	160	40 (53.62)	144 (106.2)	76	433	3500	3700	6500	<b>1PH7 163</b> - ■ ■ G ■ ■ - ■ ...
		44 (58.98)	159 (117.3)	77	459	3300	3700	6500	<b>1PH7 167</b> - ■ ■ G ■ ■ - ■ ...

#### • Separate fan:

- With separate fan
- Without separate fan, for pipe connection
- With separate fan, but with metric cable entries in accordance with EN 50262
- Without separate fan, for pipe connection, but with metric cable entries in accordance with EN 50262

2  
6  
7  
8

#### • Encoder:

- Without encoder
- Incremental encoder HTL (1,024 pulses/revolution)
- Incremental encoder HTL (2,048 pulses/revolution)

A  
H  
J

#### • Terminal box arrangement/direction of cable entry (drive-end view):

- On top/from right
- On top/from non-drive end
- On top/from left

0  
2  
3

#### • Construction type:

- IM B3 (IM V5, IM V6)
- IM B5 (IM V1, IM V3) available only for shaft height 100 and 132
- IM B35 (IM V15, IM V36)

0  
2  
3

#### • Holding brake with emergency stop function:<sup>4)</sup>

- Without brake
- Brake connection voltage: **230 V AC, 50 to 60 Hz**
- With brake
- With brake (brake includes microswitch)
- With brake (brake includes manual release)
- With brake (brake includes manual release and microswitch)
- Brake connection voltage: **24 V DC**
- With brake
- With brake (brake includes microswitch)
- With brake (brake includes manual release)
- With brake (brake includes manual release and microswitch)

0  
1  
2  
3  
4  
5  
6  
7  
8

For order number supplements for drive type, direction of air flow, and paint finish (positions 14 through 16 of the order no.), see page 3/17.

# Servo Motors for SIMOVERT MASTERDRIVES

## Asynchronous Servo Motors

1PH7 Motors

3

### Selection and Ordering Data with SIMOVERT MASTERDRIVES Vector Control (continued)

Power Factor $\cos \varphi$	Magnetizing Current $I_{\mu}$ A	Rated Efficiency $\eta_{rated}$	Rated Frequency $f_{rated}$ Hz	Moment of inertia $J$ kgm <sup>2</sup> (lb <sub>f</sub> -in-s <sup>2</sup> )	Weight, approx. kg (lb)	1PH7 Asynchronous Motors		SIMOVERT MASTERDRIVES VC Inverter/Converter Rated Current	
						Order No.		$I_{rated}$ A	Order No.
<b>Supply voltage 3-ph. AC 480 V for SIMOVERT MASTERDRIVES Vector Control</b>									
0.88	8.5	0.903	68.0	0.076 (0.6726)	90 (198.5)	1PH7 131 - . . . F . . . . ■■■■		27	6SE7 022 - 7 EP60
0.84	15	0.900	68.0	0.076 (0.6726)	90 (198.5)	1PH7 133 - . . . F . . . . ■■■■		34	6SE7 023 - 4 ■C61
0.85	17	0.905	67.8	0.109 (0.9646)	150 (330.8)	1PH7 135 - . . . F . . . . ■■■■		47	6SE7 024 - 7 ■D61
0.85	23	0.900	67.9	0.109 (0.9646)	150 (330.8)	1PH7 137 - . . . F . . . . ■■■■		59	6SE7 026 - 0 ■D61
0.85	29	0.912	67.5	0.185 (1.6372)	175 (385.9)	1PH7 163 - . . . F . . . . ■■■■		72	6SE7 027 - 2 ■D61
0.84	32	0.916	67.4	0.228 (2.0178)	210 (463.1)	1PH7 167 - . . . F . . . . ■■■■		92	6SE7 031 - 0 ■E60
0.78	8.2	0.871	90.3	0.017 (0.1504)	40 (88.2)	1PH7 103 - . . . G . . . . ■■■■		20.5	6SE7 021 - 1 EP60
0.78	12	0.887	90.2	0.029 (0.2566)	65 (143.3)	1PH7 107 - . . . G . . . . ■■■■		27	6SE7 022 - 7 EP60
0.85	17	0.898	89.6	0.076 (0.6726)	90 (198.5)	1PH7 133 - . . . G . . . . ■■■■		47	6SE7 024 - 7 ■D61
0.84	21	0.894	89.4	0.109 (0.9646)	150 (330.8)	1PH7 137 - . . . G . . . . ■■■■		59	6SE7 026 - 0 ■D61
0.82	37	0.895	89.0	0.185 (1.6372)	175 (385.9)	1PH7 163 - . . . G . . . . ■■■■		92	6SE7 031 - 0 ■E60
0.80	40	0.911	89.0	0.228 (2.0178)	210 (463.1)	1PH7 167 - . . . G . . . . ■■■■		92	6SE7 031 - 0 ■E60
<b>• Drive type:</b> Coupling and belt R Coupling and belt S Coupling and belt SR Coupling and belt N Increased max. speed <sup>5)</sup> SR						<b>• Vibration sev. grade:</b> R R R N (only in connection with brake attachment) R		<b>• Shaft and flange accuracy:</b> B C D K L	
<b>• Direction of air flow:</b> DE → NDE NDE → DE <sup>7)</sup> DE → NDE NDE → DE <sup>7)</sup> DE → NDE NDE → DE <sup>7)</sup>						<b>• Shaft end:</b> With keyway, half-key balancing With keyway, half-key balancing With keyway, full-key balancing With keyway, full-key balancing Without keyway Without keyway		A B C D J K	
<b>• Paint finish:</b> None None, flange and radial shaft sealing ring <sup>6)</sup> Anthracite gray, standard finish (RAL 7016) Anthracite gray, standard finish (RAL 7016), flange and radial shaft sealing ring <sup>6)</sup> Anthracite gray, special finish (RAL 7016) Anthracite gray, special finish (RAL 7016), flange and radial shaft sealing ring <sup>6)</sup>						0 2 3 5 6 8			
<b>• Special models:</b> Please specify additional order code and any required plain text; see Page 3/3.						-Z			
Converter Inverter								E T	

- $n_1$ : Maximum permissible speed at constant power or speed where for  $P = P_{rated}$ , there is still a 30% power reserve up to the stall limit.
- $n_{S1}$ : Maximum permissible speed that is continuously permitted without speed duty cycles.
- $n_{max}$ : Maximum rotational speed. This speed may not be exceeded! Notice: Due to  $f_{max} < 5 \cdot f_{rated}$ , the maximum rotational speed is sometimes limited to smaller values.
- For model with brake: 12th position in ordering no. is "2" or "3"; 14th position is "K"; 15th position is "A", "B", "J" or "K"; 16th position "0", "3" or "6".
- Max. permissible rotational speed (see also Part 7)  
Shaft height 100: 12000 rpm, 132: 10000 rpm, 160: 8000 rpm, only with keyless shaft (15th position is "J" or "K")
- Model prepared for ZF gearbox attachment: 12th data position is "2" or "3"; 13th position is "0"; 14th position is "B", 15th position is "C" or "D"; 16th position is "2", "5" or "8". Stagnant fluids are not permitted at the shaft exit.
- Preferred air flow direction in contaminated environments.

# Servo Motors for SIMOVERT MASTERDRIVES

## Asynchronous Servo Motors

### 1PH7 Motors

3

#### Selection and Ordering Data with SIMOVERT MASTERDRIVES Vector Control

Rated Rotational Speed	Shaft Height	Rated Output	Rated Torque	Rated Current	Rated Voltage	Speed during Field Weakening <sup>1)</sup>	Max. Permissible Continuous Speed <sup>2)</sup>	Max. Speed <sup>3)</sup>	1PH7 Asynchronous Motors
$n_{rated}$		$P_{rated}$	$M_{rated}$	$I_{rated}$	$V_{rated}$	$n_1$	$n_{S1}$	$n_{max}$	Order No.
rpm	SH	kW (HP)	Nm (lb <sub>f</sub> -ft)	A	V	rpm	rpm	rpm	
<b>Supply voltage 3-ph. AC 480 V for SIMOVERT MASTERDRIVES Vector Control</b>									
<b>500</b>	180	20.5 (27.48)	392 (289.1)	51	335	2500	2500	2500	<b>1PH7 184 - ■ ■ B ■ ■ - ■ . . .</b>
		26.5 (35.52)	506 (373.2)	67	335	2500	2500	2500	<b>1PH7 186 - ■ ■ B ■ ■ - ■ . . .</b>
	225	38 (50.94)	725 (534.8)	86	335	2200	2500	2500	<b>1PH7 224 - ■ ■ B ■ ■ - ■ . . .</b>
		49 (65.68)	935 (689.7)	112	330	2500	2500	2500	<b>1PH7 226 - ■ ■ B ■ ■ - ■ . . .</b>
		60 (80.43)	1145 (844.6)	135	340	2500	2500	2500	<b>1PH7 228 - ■ ■ B ■ ■ - ■ . . .</b>
<b>1350</b>	180	50 (67.02)	375 (276.6)	86	450	3700	3500 <sup>4)</sup>	5000	<b>1PH7 184 - ■ ■ D ■ ■ - ■ . . .</b>
		67 (89.81)	475 (350.4)	114	460	3800	3500 <sup>4)</sup>	5000	<b>1PH7 186 - ■ ■ D ■ ■ - ■ . . .</b>
	225	92 (123.32)	650 (479.4)	156	450	2900	3100 <sup>4)</sup>	4500	<b>1PH7 224 - ■ ■ D ■ ■ - ■ . . .</b>
		120 (160.86)	847 (624.7)	193	460	2900	3100 <sup>4)</sup>	4500	<b>1PH7 226 - ■ ■ D ■ ■ - ■ . . .</b>
		147 (197.05)	1043 (769.3)	232	460	2900	3100 <sup>4)</sup>	4500 <sup>4)</sup>	<b>1PH7 228 - ■ ■ D ■ ■ - ■ . . .</b>

- Separate fan:**  
 With separate fan 2  
 Without separate fan, for pipe connection 6  
 With separate fan, but with metric cable entries in accordance with EN 50262 7  
 Without separate fan, for pipe connection, but with metric cable entries in accordance with EN 50262 8
- Encoder:**  
 Without encoder A  
 Incremental encoder HTL (1,024 pulses/revolution) H  
 Incremental encoder HTL (2,048 pulses/revolution) J
- Terminal box arrangement/direction of cable entry (drive-end view):**  
 On top/from right 0  
 On top/from drive end 1  
 On top/from non-drive end 2  
 On top/from left 3
- Construction type:**  
 IM B3 0  
 IM B3 1  
 IM B35 (only for 1PH7 184 with flange A 400) 3  
 IM B35 (only for 1PH7 184 with flange A 450) 4  
 IM B35 (for 1PH7 186 with flange A 450 and 1PH 722. with flange A 550) 3  
 IM B35 (only for 1PH7 184 with flange A 400) 5  
 IM B35 (only for 1PH7 184 with flange A 450) 6  
 IM B35 (for 1PH7 186 with flange A 450 and 1PH7 22. with flange A 550) 5
- Holding brake with emergency stop function (suitable for IM B3 coupling drive)<sup>5)</sup>:**  
 Without brake 0  
 With brake (brake includes emergency release screws and microswitch) 2  
 With brake (brake includes manual release and microswitch) 4

For order number supplements for drive type, direction of air flow, and paint finish (positions 14 through 16 of the order no.), see page 3/19.

# Servo Motors for SIMOVERT MASTERDRIVES

## Asynchronous Servo Motors

1PH7 Motors

3

### Selection and Ordering Data with SIMOVERT MASTERDRIVES Vector Control

Power Factor $\cos \varphi$	Magnetizing Current $I_{\mu}$ A	Rated Efficiency $\eta_{rated}$	Rated Frequency $f_{rated}$ Hz	Moment of inertia $J$ kgm <sup>2</sup> (lb <sub>f</sub> -in-s <sup>2</sup> )	Weight, approx. kg (lb)	1PH7 Asynchronous Motors		SIMOVERT MASTERDRIVES VC Inverter/Converter Rated Current	
						Order No.	$I_{rated}$ A	Order No.	
<b>Supply voltage 3-ph. AC 480 V for SIMOVERT MASTERDRIVES Vector Control</b>									
0.83	26	0.858	17.5	0.503 (4.4545)	370 (815.8)	1PH7 184 - . . . B . . . . ■■■■	59	6SE7 026 - 0 ■ D61	
0.79	39.5	0.870	17.3	0.666 (5.894)	440 (970.2)	1PH7 186 - . . . B . . . . ■■■■	72	6SE7 027 - 2 ■ D61	
0.85	37.5	0.888	17.3	1.479 (13.0889)	630 (1389.2)	1PH7 224 - . . . B . . . . ■■■■	92	6SE7 031 - 0 ■ E60	
0.85	50	0.900	17.3	1.930 (17.0802)	750 (1653.8)	1PH7 226 - . . . B . . . . ■■■■	124	6SE7 031 - 2 ■ F60	
0.84	61.5	0.907	17.2	2.326 (20.5848)	860 (1896.3)	1PH7 228 - . . . B . . . . ■■■■	146	6SE7 031 - 5 ■ F60	
0.81	42	0.928	45.8	0.503 (4.4545)	370 (815.8)	1PH7 184 - . . . D . . . . ■■■■	92	6SE7 031 - 0 ■ E60	
0.79	59.5	0.930	45.7	0.666 (5.894)	440 (970.2)	1PH7 186 - . . . D . . . . ■■■■	124	6SE7 031 - 2 ■ F60	
0.80	78.5	0.942	45.6	1.479 (13.0889)	630 (1389.2)	1PH7 224 - . . . D . . . . ■■■■	186	6SE7 031 - 8 ■ F60	
0.82	88.5	0.945	45.6	1.930 (17.0802)	750 (1653.8)	1PH7 226 - . . . D . . . . ■■■■	210	6SE7 032 - 1 ■ G60	
0.84	99.5	0.947	45.6	2.326 (20.5848)	860 (1896.3)	1PH7 228 - . . . D . . . . ■■■■	260	6SE7 032 - 6 ■ G60	
<ul style="list-style-type: none"> <li><b>Drive type:</b> <ul style="list-style-type: none"> <li>Coupling R</li> <li>Coupling R</li> <li>Coupling S</li> <li>Coupling SR</li> <li>Belt R</li> <li>Belt R</li> <li>Increased cantilever forces R</li> <li>Increased cantilever forces R</li> <li>Increased maximum speed<sup>6)</sup> S</li> </ul> </li> <li><b>Vibration sev. grade:</b> <ul style="list-style-type: none"> <li>R</li> <li>R</li> <li>R</li> <li>R</li> <li>N</li> <li>R</li> <li>N</li> <li>R</li> <li>S</li> </ul> </li> <li><b>Shaft and flange accuracy:</b> <ul style="list-style-type: none"> <li>N</li> <li>R</li> <li>R</li> <li>R</li> <li>N</li> <li>R</li> <li>N</li> <li>R</li> <li>R</li> </ul> </li> </ul>						A B C D E F G H J			
<ul style="list-style-type: none"> <li><b>Direction of air flow:</b> <ul style="list-style-type: none"> <li>DE → NDE</li> <li>NDE → DE<sup>8)</sup></li> <li>DE → NDE</li> <li>NDE → DE<sup>8)</sup></li> <li>DE → NDE</li> <li>NDE → DE<sup>8)</sup></li> </ul> </li> <li><b>Shaft end:</b> <ul style="list-style-type: none"> <li>With keyway, half-key balancing</li> <li>With keyway, half-key balancing</li> <li>With keyway, full-key balancing</li> <li>With keyway, full-key balancing</li> <li>Without keyway</li> <li>Without keyway</li> </ul> </li> </ul>						A B C D J K			
<ul style="list-style-type: none"> <li><b>Paint finish:</b> <ul style="list-style-type: none"> <li>Primed</li> <li>Primed, prepared for ZF gearbox attachment<sup>7)</sup></li> <li>Anthracite gray, standard finish (RAL 7016)</li> <li>Anthracite gray, standard finish (RAL 7016), prepared for ZF gearbox attachment<sup>7)</sup></li> <li>Anthracite gray, special finish (RAL 7016)</li> <li>Anthracite gray, special finish (RAL 7016), prepared for ZF gearbox attachment<sup>7)</sup></li> </ul> </li> </ul>						0 2 3 5 6 8			
<ul style="list-style-type: none"> <li><b>Special models:</b> <ul style="list-style-type: none"> <li>Please specify additional order code and any required plain text; see Page 3/3.</li> </ul> </li> </ul>						-Z			
<ul style="list-style-type: none"> <li>Converter</li> <li>Inverter</li> </ul>								E T	

- $n_1$ : Maximum permissible speed at constant power or speed where for  $P = P_{rated}$ , there is still a 30% power reserve up to the stall limit.
- $n_{S1}$ : Maximum permissible speed that is continuously permitted without speed duty cycles.
- $n_{max}$ : Maximum rotational speed. This speed may not be exceeded! Notice: Due to  $f_{max} < 5 \cdot f_{rated}$ , the maximum rotational speed is sometimes limited to smaller values.
- Rotational speed is reduced in the event of increased cantilever forces, see Part 7.
- For model with brake: 12th data position "0", 14th and 15th position "A", 16th position "0", "3" or "6".
- For shaft height 180  $n_{max} = 7000$  rpm, 1PH7 224  $n_{max} = 5500$  rpm, coupling drive only.
- Model prepared for ZF gearbox attachment: Only for types 1PH7 184, 186, and 224, 12th data position is "3" or "5", 13th is "0"; 14th is "B"; 15th is "C"; 16th is "2", "5" or "8". Stagnant fluids are not permitted at the shaft exit.
- Preferred air flow direction in contaminated environments.

# Servo Motors for SIMOVERT MASTERDRIVES

## Asynchronous Servo Motors

### 1PH7 Motors

#### Selection and Ordering Data with SIMOVERT MASTERDRIVES Vector Control (continued)

Rated Rotational Speed	Shaft Height	Rated Output	Rated Torque	Rated Current	Rated Voltage	Speed during Field Weakening <sup>1)</sup>	Max. Permissible Continuous Speed <sup>2)</sup>	Max. Speed <sup>3)</sup>	1PH7 Asynchronous Motors
$n_{rated}$		$P_{rated}$	$M_{rated}$	$I_{rated}$	$V_{rated}$	$n_1$	$n_{S1}$	$n_{max}$	Order No.
rpm	SH	kW (HP)	Nm (lb <sub>f</sub> -ft)	A	V	rpm	rpm	rpm	
<b>Supply voltage 3-ph. AC 480 V for SIMOVERT MASTERDRIVES Vector Control</b>									
<b>2000</b>	180	68 (91.15)	325 (239.7)	120	450	5000	3500 <sup>4)</sup>	5000	<b>1PH7 184 - ■ ■ F ■ ■ - ■ . . .</b>
		94 (126.01)	450 (331.9)	165	445	5000	3500 <sup>4)</sup>	5000	<b>1PH7 186 - ■ ■ F ■ ■ - ■ . . .</b>
	225	124 (166.22)	590 (435.2)	200	460	2900	3100 <sup>4)</sup>	4500	<b>1PH7 224 - ■ ■ U ■ ■ - ■ . . .</b>
		153 (205.09)	730 (538.5)	254	450	2900	3100 <sup>4)</sup>	4500	<b>1PH7 226 - ■ ■ F ■ ■ - ■ . . .</b>
		196 (262.73)	936 (690.4)	332	450	3000	3100 <sup>4)</sup>	4500 <sup>4)</sup>	<b>1PH7 228 - ■ ■ F ■ ■ - ■ . . .</b>
<b>2900</b>	180	81 (108.58)	267 (196.9)	158	395	5000	3500 <sup>4)</sup>	5000	<b>1PH7 184 - ■ ■ L ■ ■ - ■ . . .</b>
		101 (135.39)	333 (245.6)	206	385	5000	3500 <sup>4)</sup>	5000	<b>1PH7 186 - ■ ■ L ■ ■ - ■ . . .</b>
	225	149 (199.73)	490 (361.4)	274	395	3500	3100 <sup>4)</sup>	4500	<b>1PH7 224 - ■ ■ L ■ ■ - ■ . . .</b>
		185 (247.99)	610 (449.9)	348	390	3500	3100 <sup>4)</sup>	4500	<b>1PH7 226 - ■ ■ L ■ ■ - ■ . . .</b>
		215 (288.2)	708 (522.2)	402	395	3500	3100 <sup>4)</sup>	4500 <sup>4)</sup>	<b>1PH7 228 - ■ ■ L ■ ■ - ■ . . .</b>

- Separate fan:**
  - With separate fan
  - Without separate fan, for pipe connection
  - With separate fan, but with metric cable entries in accordance with EN 50262
  - Without separate fan, for pipe connection, but with metric cable entries in accordance with EN 50262

2  
6  
7  
8

- Encoder:**
  - Without encoder
  - Incremental encoder HTL (1,024 pulses/revolution)
  - Incremental encoder HTL (2,048 pulses/revolution)

A  
H  
J

- Terminal box arrangement/direction of cable entry (drive-end view):**
  - On top/from right
  - On top/from drive end
  - On top/from non-drive end
  - On top/from left

0  
1  
2  
3

**Construction type:**

- IM B3
  - IM B3
  - IM B35 (only for 1PH7 184 with flange A 400)
  - IM B35 (only for 1PH7 184 with flange A 450)
  - IM B35 (for 1PH7 186 with flange A 450 and 1PH 722. with flange A 550)
  - IM B35 (only for 1PH7 184 with flange A 400)
  - IM B35 (only for 1PH7 184 with flange A 450)
  - IM B35 (for 1PH7 186 with flange A 450 and 1PH7 22. with flange A 550)
- Hoisting concept for other construction types (IM B6, IM B7, IM B8, IM V5, IM V6)
- Hoisting concept for other construction types (IM V15, IM V36)
- Hoisting concept for other construction types (IM V15, IM V36)
- Hoisting concept for other construction types (IM V15, IM V36)

0  
1  
3  
3  
5  
6  
5

- Holding brake with emergency stop function (suitable for IM B3 coupling drive)<sup>5)</sup>:**
  - Without brake
  - With brake (brake includes emergency release screws and microswitch)
  - With brake (brake includes manual release and microswitch)

0  
2  
4

For order number supplements for drive type, direction of air flow, and paint finish (positions 14 through 16 of the order no.), see page 3/21.

3



# Servo Motors for SIMOVERT MASTERDRIVES

## Asynchronous Servo Motors

1PH7 Motors

### Selection and Ordering Data with SIMOVERT MASTERDRIVES Vector Control (continued)

Power Factor $\cos \varphi$	Magnetizing Current $I_{\mu}$ A	Rated Efficiency $\eta_{rated}$	Rated Frequency $f_{rated}$ Hz	Moment of inertia $J$ kgm <sup>2</sup> (lb <sub>f</sub> -in-s <sup>2</sup> )	Weight, approx. kg (lb)	1PH7 Asynchronous Motors		SIMOVERT MASTERDRIVES VC Inverter/Converter Rated Current	
						Order No.	$I_{rated}$ A	Order No.	
<b>Supply voltage 3-ph. AC 480 V for SIMOVERT MASTERDRIVES Vector Control</b>									
0.78	66	0.935	67.3	0.503 (4.4545)	370 (815.8)	1PH7 184 - . . . F . . . . ■■■■	124	6SE7 031 - 2 ■ F60	
0.78	87	0.941	67.3	0.666 (5.894)	440 (970.2)	1PH7 186 - . . . F . . . . ■■■■	186	6SE7 031 - 8 ■ F60	
0.82	91	0.944	67.2	1.479 (13.0889)	630 (1389.2)	1PH7 224 - . . . U . . . . ■■■■	210	6SE7 032 - 1 ■ G60	
0.82	119	0.948	67.2	1.930 (17.0802)	750 (1653.8)	1PH7 226 - . . . F . . . . ■■■■	260	6SE7 032 - 6 ■ G60	
0.79	168	0.950	67.1	2.326 (20.5848)	860 (1896.3)	1PH7 228 - . . . F . . . . ■■■■	370	6SE7 033 - 7 ■ G60	
0.80	77	0.934	97.4	0.503 (4.4545)	370 (815.8)	1PH7 184 - . . . L . . . . ■■■■	186	6SE7 031 - 8 ■ F60	
0.78	107	0.936	97.3	0.666 (5.894)	440 (970.2)	1PH7 186 - . . . L . . . . ■■■■	210	6SE7 032 - 1 ■ G60	
0.84	115	0.946	97.3	1.479 (13.0889)	630 (1389.2)	1PH7 224 - . . . L . . . . ■■■■	315	6SE7 033 - 2 ■ G60	
0.83	154	0.946	97.2	1.930 (17.0802)	750 (1653.8)	1PH7 226 - . . . L . . . . ■■■■	370	6SE7 033 - 7 ■ G60	
0.82	188	0.954	97.2	2.326 (20.5848)	860 (1896.3)	1PH7 228 - . . . L . . . . ■■■■	510	6SE7 035 - 1 ■ K/J60	
<ul style="list-style-type: none"> <li><b>Drive type:</b> <ul style="list-style-type: none"> <li>Coupling R</li> <li>Coupling R</li> <li>Coupling S</li> <li>Coupling SR</li> <li>Belt R</li> <li>Belt R</li> <li>Increased cantilever forces R</li> <li>Increased cantilever forces R</li> <li>Increased maximum speed<sup>6)</sup> S</li> </ul> </li> <li><b>Vibration sev. grade:</b> <ul style="list-style-type: none"> <li>R</li> <li>R</li> <li>R</li> <li>R</li> <li>N</li> <li>R</li> <li>N</li> <li>R</li> <li>S</li> </ul> </li> <li><b>Shaft and flange accuracy:</b> <ul style="list-style-type: none"> <li>N</li> <li>R</li> <li>R</li> <li>R</li> <li>N</li> <li>R</li> <li>N</li> <li>R</li> <li>R</li> </ul> </li> </ul>						A B C D E F G H J			
<ul style="list-style-type: none"> <li><b>Direction of air flow:</b> <ul style="list-style-type: none"> <li>DE → NDE</li> <li>NDE → DE<sup>8)</sup></li> <li>DE → NDE</li> <li>NDE → DE<sup>8)</sup></li> <li>DE → NDE</li> <li>NDE → DE<sup>8)</sup></li> </ul> </li> <li><b>Shaft end:</b> <ul style="list-style-type: none"> <li>With keyway, half-key balancing</li> <li>With keyway, half-key balancing</li> <li>With keyway, full-key balancing</li> <li>With keyway, full-key balancing</li> <li>Without keyway</li> <li>Without keyway</li> </ul> </li> </ul>						A B C D J K			
<ul style="list-style-type: none"> <li><b>Paint finish:</b> <ul style="list-style-type: none"> <li>Primed</li> <li>Primed, prepared for ZF gearbox attachment<sup>7)</sup></li> <li>Anthracite gray, standard finish (RAL 7016)</li> <li>Anthracite gray, standard finish (RAL 7016), prepared for ZF gearbox attachment<sup>7)</sup></li> <li>Anthracite gray, special finish (RAL 7016)</li> <li>Anthracite gray, special finish (RAL 7016), prepared for ZF gearbox attachment<sup>7)</sup></li> </ul> </li> </ul>						0 2 3 5 6 8			
<ul style="list-style-type: none"> <li><b>Special models:</b> <ul style="list-style-type: none"> <li>Please specify additional order code and any required plain text; see Page 3/3.</li> </ul> </li> </ul>						-Z			
Converter Inverter								E T	

- $n_1$ : Maximum permissible speed at constant power or speed where for  $P = P_{rated}$ , there is still a 30% power reserve up to the stall limit.
- $n_{S1}$ : Maximum permissible speed that is continuously permitted without speed duty cycles.
- $n_{max}$ : Maximum rotational speed. This speed may not be exceeded! Notice: Due to  $f_{max} < 5 \cdot f_{rated}$ , the maximum rotational speed is sometimes limited to smaller values.
- Rotational speed is reduced in the event of increased cantilever forces, see Part 7.
- For model with brake: 12th data position "0", 14th and 15th position "A", 16th position "0", "3" or "6".
- For shaft height 180  $n_{max} = 7000$  rpm, 1PH7 224  $n_{max} = 5500$  rpm, coupling drive only.
- Model prepared for ZF gearbox attachment: Only for types 1PH7 184, 186, and 224, 12th data position is "3" or "5", 13th is "0"; 14th is "B"; 15th is "C"; 16th is "2", "5" or "8". Stagnant fluids are not permitted at the shaft exit.
- Preferred air flow direction in contaminated environments.



# Servo Motors for SIMOVERT MASTERDRIVES

## Asynchronous Servo Motors

### 1PH7 Motors

#### Selection and Ordering Data with SIMOVERT MASTERDRIVES Vector Control

Rated Rotational Speed	Shaft Height	Rated Output	Rated Torque	Rated Current	Rated Voltage	Speed during Field Weakening <sup>1)</sup>	Max. Permissible Continuous Speed <sup>2)</sup>	Max. Speed <sup>3)</sup>	1PH7 Asynchronous Motors
$n_{rated}$	SH	$P_{rated}$	$M_{rated}$	$I_{rated}$	$V_{rated}$	$n_1$	$n_{S1}$	$n_{max}$	Order No.
rpm		kW (HP)	Nm (lb <sub>f</sub> -ft)	A	V	rpm	rpm	rpm	
<b>Supply voltage 3-ph. AC 480 V for SIMOVERT MASTERDRIVES Vector Control</b>									
600	280	95 (127.35)	1519 (1120.4)	144	480	1650	2200	3000	1PH7 284 - ■ ■ B ■ ■ - 0 ...
		120 (160.86)	1916 (1413.2)	180	480	1750	2200	3000	1PH7 286 - ■ ■ B ■ ■ - 0 ...
		155 (207.77)	2474 (1824.8)	233	480	1850	2200	3000	1PH7 288 - ■ ■ B ■ ■ - 0 ...
1000	280	150 (201.07)	1433 (1057)	220	480	2200	2200	3300	1PH7 284 - ■ ■ C ■ ■ - 0 ...
		185 (247.99)	1767 (1303.3)	285	480	2200	2200	3300	1PH7 286 - ■ ■ C ■ ■ - 0 ...
		230 (308.31)	2197 (1620.5)	365	460	2200	2200	3300	1PH7 288 - ■ ■ C ■ ■ - 0 ...
1350	280	200 (268.1)	1416 (1044.4)	314	470	2200	2200	3300	1PH7 284 - ■ ■ D ■ ■ - 0 ...
		245 (328.42)	1733 (1278.3)	414	445	2200	2200	3300	1PH7 286 - ■ ■ D ■ ■ - 0 ...
		305 (408.85)	2158 (1591.7)	497	450	2200	2200	3300	1PH7 288 - ■ ■ D ■ ■ - 0 ...
2000	280	255 (341.82)	1218 (898.4)	393	455	2200	2200	3300	1PH7 284 - ■ ■ F ■ ■ - 0 ...
		310 (415.55)	1481 (1092.4)	466	455	2200	2200	3300	1PH7 286 - ■ ■ F ■ ■ - 0 ...
		385 (516.09)	1838 (1355.7)	586	455	2200	2200	3300	1PH7 288 - ■ ■ F ■ ■ - 0 ...

• **Separate fan:**<sup>4)</sup>

- With separate fan, non-drive end on top, air flow non-drive end to drive end
- With separate fan, non-drive end on the right, air flow non-drive end to drive end
- With separate fan, non-drive end on the left, air flow non-drive end to drive end
- With separate fan, drive end on top, air flow drive end to non-drive end
- With separate fan, drive end on the right, air flow drive end to non-drive end
- With separate fan, drive end on the left, air flow drive end to non-drive end
- Without separate fan, for simple pipe connection on non-drive end on the right

0  
1  
2  
3  
4  
5  
6

• **Encoder:**

- Without encoder
- Incremental encoder HTL (1,024 pulses/revolution)
- Incremental encoder HTL (2,048 pulses/revolution)

A  
H  
J

• **Terminal box/direction of cable entry (drive-end view):**<sup>4)</sup>

- Terminal box non-drive side on right/cable entry on bottom/encoder connector on drive side
- Terminal box non-drive side on left/cable entry on bottom/encoder connector on drive side
- Terminal box non-drive side on top/cable entry on right/encoder connector on drive side
- Terminal box drive side on top/cable entry on right/encoder connector on non-drive side

0  
1  
2  
5

• **Construction type:**<sup>4)</sup>

- IM B3
- IM V5 (can be converted later to IM V6)
- IM B35 (with flange A 660)
- IM V15 (with flange A 660; can be converted later to IM V36)

0  
1  
3  
5

For order number supplements for drive type, direction of air flow, and paint finish (positions 14 through 16 of the order no.), see page 3/23.

# Servo Motors for SIMOVERT MASTERDRIVES

## Asynchronous Servo Motors

1PH7 Motors

### Selection and Ordering Data with SIMOVERT MASTERDRIVES Vector Control

Power Factor	Magnetizing Current $I_{\mu}$ A	Rated Efficiency $\eta_{rated}$	Rated Frequency $f_{rated}$ Hz	Moment of inertia $J$ kgm <sup>2</sup> (lb <sub>f</sub> -in-s <sup>2</sup> )	Weight, approx. kg (lb)	1PH7 Asynchronous Motors	SIMOVERT MASTERDRIVES VC Inverter/Converter Rated Current	
						Order No.	$I_{rated}$ A	Order No.
<b>Supply voltage 3-ph. AC 480 V for SIMOVERT MASTERDRIVES Vector Control</b>								
0.86	61	0.932	20.3	4.2 (37.1694)	1300 (2866.5)	1PH7 284 - . . B . . - 0 ■ ■ ■ ■	146	6SE7 031 - 5 ■ F60
0.86	80	0.939	20.3	5.2 (46.0192)	1500 (3307.5)	1PH7 286 - . . B . . - 0 ■ ■ ■ ■	186	6SE7 031 - 8 ■ F60
0.86	102	0.941	20.3	6.3 (55.754)	1700 (3748.5)	1PH7 288 - . . B . . - 0 ■ ■ ■ ■	260	6SE7 032 - 6 ■ G60
0.86	90	0.950	34.0	4.2 (37.1694)	1300 (2866.5)	1PH7 284 - . . C . . - 0 ■ ■ ■ ■	260	6SE7 032 - 6 ■ G60
0.84	135	0.954	34.0	5.2 (46.0192)	1500 (3307.5)	1PH7 286 - . . C . . - 0 ■ ■ ■ ■	370	6SE7 033 - 7 ■ G60
0.84	170	0.956	34.0	6.3 (55.754)	1700 (3748.5)	1PH7 288 - . . C . . - 0 ■ ■ ■ ■	370	6SE7 033 - 7 ■ G60
0.82	159	0.958	45.3	4.2 (37.1694)	1300 (2866.5)	1PH7 284 - . . D . . - 0 ■ ■ ■ ■	315	6SE7 033 - 2 ■ G60
0.80	217	0.960	45.3	5.2 (46.0192)	1500 (3307.5)	1PH7 286 - . . D . . - 0 ■ ■ ■ ■	510	6SE7 035 - 1 ■ K/J60
0.82	250	0.962	45.3	6.3 (55.754)	1700 (3748.5)	1PH7 288 - . . D . . - 0 ■ ■ ■ ■	510	6SE7 035 - 1 ■ K/J60
0.86	162	0.962	67.0	4.2 (37.1694)	1300 (2866.5)	1PH7 284 - . . F . . - 0 ■ ■ ■ ■	510	6SE7 035 - 1 ■ K/J60
0.87	182	0.964	67.0	5.2 (46.0192)	1500 (3307.5)	1PH7 286 - . . F . . - 0 ■ ■ ■ ■	510	6SE7 035 - 1 ■ K/J60
0.87	232	0.965	67.0	6.3 (55.754)	1700 (3748.5)	1PH7 288 - . . F . . - 0 ■ ■ ■ ■	590	6SE7 036 - 0 ■ K/J60
<ul style="list-style-type: none"> <li>• <b>Drive type:</b><sup>4)</sup> Coupling N Coupling R Belt/increased cantilever forces N Belt/increased cantilever forces R</li> <li>• <b>Vibration sev. grade:</b> N R N R</li> <li>• <b>Shaft and flange accuracy:</b> N R N R</li> </ul>						A B E F		
<ul style="list-style-type: none"> <li>• <b>Shaft end:</b> With keyway, half-key balancing With keyway, full-key balancing Without keyway</li> </ul>						A C J		
<ul style="list-style-type: none"> <li>• <b>Paint finish:</b> Primed Anthracite gray, standard finish (RAL 7016) Anthracite gray, special finish (RAL 7016)</li> </ul>						0 3 6		
<ul style="list-style-type: none"> <li>• <b>Special models:</b> Please specify additional order code and any required plain text; see Page 3/3.</li> </ul>						-Z		
Converter Inverter							E T	

1)  $n_1$ : Maximum permissible speed at constant power or speed where for  $P = P_{rated}$ , there is still a 30% power reserve up to the stall limit.  
2)  $n_{S1}$ : Maximum permissible speed that is continuously permitted without speed duty cycles.

3)  $n_{max}$ : Maximum rotational speed. This speed may not be exceeded!  
Notice: Due to  $f_{max} < 5 \cdot f_{rated}$ , the maximum rotational speed is sometimes limited to smaller values.  
4) For possible combinations, refer to page 3/42.

# Servo Motors for SIMOVERT MASTERDRIVES

## Asynchronous Servo Motors

### 1PH7 Motors

#### Selection and Ordering Data with SIMOVERT MASTERDRIVES Vector Control

Rated Rotational Speed	Shaft Height	Rated Output	Rated Torque	Rated Current	Rated Voltage	Speed during Field Weakening <sup>1)</sup>	Max. Permissible Continuous Speed <sup>2)</sup>	Max. Speed <sup>3)</sup>	1PH7 Asynchronous Motors
$n_{rated}$		$P_{rated}$	$M_{rated}$	$I_{rated}$	$V_{rated}$	$n_1$	$n_{S1}$	$n_{max}$	Order No.
rpm	SH	kW (HP)	Nm (lb <sub>f</sub> -ft)	A	V	rpm	rpm	rpm	
<b>Supply voltage 3-ph. AC 690 V for SIMOVERT MASTERDRIVES Vector Control (Option C30)</b>									
500	280	77 (103.22)	1471 (1085)	80	690	1150	2200	2500	1PH7 284 - ■ ■ B ■ ■ - 0 ...
		96 (128.69)	1834 (1352.8)	101	690	1300	2200	2500	1PH7 286 - ■ ■ B ■ ■ - 0 ...
		125 (167.56)	2388 (1761.4)	130	690	1400	2200	2500	1PH7 288 - ■ ■ B ■ ■ - 0 ...
800	280	115 (154.16)	1373 (1012.7)	120	690	2200	2200	3300	1PH7 284 - ■ ■ C ■ ■ - 0 ...
		145 (194.37)	1731 (1276.8)	160	665	2200	2200	3300	1PH7 286 - ■ ■ C ■ ■ - 0 ...
		185 (247.99)	2208 (1628.6)	210	640	2200	2200	3300	1PH7 288 - ■ ■ C ■ ■ - 0 ...
1150	280	164 (219.84)	1362 (1004.6)	176	690	2200	2200	3300	1PH7 284 - ■ ■ D ■ ■ - 0 ...
		203 (272.12)	1686 (1243.6)	233	655	2200	2200	3300	1PH7 286 - ■ ■ D ■ ■ - 0 ...
		251 (336.46)	2084 (1537.2)	280	665	2200	2200	3300	1PH7 288 - ■ ■ D ■ ■ - 0 ...
1750	280	217 (290.88)	1184 (873.3)	221	690	2200	2200	3300	1PH7 284 - ■ ■ F ■ ■ - 0 ...
		261 (349.87)	1424 (1050.3)	262	690	2200	2200	3300	1PH7 286 - ■ ■ F ■ ■ - 0 ...
		329 (441.02)	1795 (1323.9)	330	690	2200	2200	3300	1PH7 288 - ■ ■ F ■ ■ - 0 ...

- **Separate fan:<sup>5)</sup>**
  - With separate fan, non-drive end on top, air flow non-drive end to drive end
  - With separate fan, non-drive end on the right, air flow non-drive end to drive end
  - With separate fan, non-drive end on the left, air flow non-drive end to drive end
  - With separate fan, drive end on top, air flow drive end to non-drive end
  - With separate fan, drive end on the right, air flow drive end to non-drive end
  - With separate fan, drive end on the left, air flow drive end to non-drive end
  - Without separate fan, for simple pipe connection on non-drive end on the right

0  
1  
2  
3  
4  
5  
6

- **Encoder:**
  - Without encoder
  - Incremental encoder HTL (1,024 pulses/revolution)
  - Incremental encoder HTL (2,048 pulses/revolution)

A  
H  
J

- **Terminal box/direction of cable entry (drive-end view):<sup>5)</sup>**
  - Terminal box non-drive side on right/cable entry on bottom/encoder connector on drive side
  - Terminal box non-drive side on left/cable entry on bottom/encoder connector on drive side
  - Terminal box non-drive side on top/cable entry on right/encoder connector on drive side
  - Terminal box drive side on top/cable entry on right/encoder connector on non-drive side

0  
1  
2  
5

- **Construction type:<sup>5)</sup>**
  - IM B3
  - IM V5 (can be converted later to IM V6)
  - IM B35 (with flange A 660)
  - IM V15 (with flange A 660; can be converted later to IM V36)

0  
1  
3  
5

For order number supplements for drive type, direction of air flow, and paint finish (positions 14 through 16 of the order no.), see page 3/25.

# Servo Motors for SIMOVERT MASTERDRIVES

## Asynchronous Servo Motors

1PH7 Motors

### Selection and Ordering Data with SIMOVERT MASTERDRIVES Vector Control

Power Factor	Magnetizing Current $I_{\mu}$ A	Rated Efficiency $\eta_{rated}$	Rated Frequency $f_{rated}$ Hz	Moment of inertia $J$ kgm <sup>2</sup> (lb <sub>f</sub> -in-s <sup>2</sup> )	Weight, approx. kg (lb)	1PH7 Asynchronous Motors	SIMOVERT MASTERDRIVES VC Inverter/Converter Rated Current	
						Order No.	$I_{rated}$ A	Order No.
<b>Supply voltage 3-ph. AC 690 V for SIMOVERT MASTERDRIVES Vector Control (Option C30)</b>								
0.87	34	0.923	17.0	4.2 (37.1694)	1300 (2866.5)	1PH7 284 - . . B . . - 0 ■■■■	82	6SE7 028 - 2 ■ G60
0.86	45	0.927	17.0	5.2 (46.0192)	1500 (3307.5)	1PH7 286 - . . B . . - 0 ■■■■	118	6SE7 031 - 2 ■ G60
0.86	57	0.930	17.0	6.3 (55.754)	1700 (3748.5)	1PH7 288 - . . B . . - 0 ■■■■	145	6SE7 031 - 5 ■ G60
0.85	55	0.943	27.0	4.2 (37.1694)	1300 (2866.5)	1PH7 284 - . . C . . - 0 ■■■■	118 <sup>4)</sup>	6SE7 031 - 2 ■ G60
0.84	80	0.947	27.0	5.2 (46.0192)	1500 (3307.5)	1PH7 286 - . . C . . - 0 ■■■■	171	6SE7 031 - 7 ■ G60
0.84	100	0.950	27.0	6.3 (55.754)	1700 (3748.5)	1PH7 288 - . . C . . - 0 ■■■■	208 <sup>4)</sup>	6SE7 032 - 1 ■ G60
0.81	91	0.955	38.6	4.2 (37.1694)	1300 (2866.5)	1PH7 284 - . . D . . - 0 ■■■■	171 <sup>4)</sup>	6SE7 031 - 7 ■ G60
0.80	125	0.957	38.6	5.2 (46.0192)	1500 (3307.5)	1PH7 286 - . . D . . - 0 ■■■■	297	6SE7 033 - 0 ■ K/J60
0.81	145	0.959	38.6	6.3 (55.754)	1700 (3748.5)	1PH7 288 - . . D . . - 0 ■■■■	297	6SE7 033 - 0 ■ K/J60
0.86	94	0.961	58.7	4.2 (37.1694)	1300 (2866.5)	1PH7 284 - . . F . . - 0 ■■■■	208 <sup>4)</sup>	6SE7 032 - 1 ■ G60
0.87	105	0.963	58.7	5.2 (46.0192)	1500 (3307.5)	1PH7 286 - . . F . . - 0 ■■■■	297	6SE7 033 - 0 ■ K/J60
0.86	134	0.964	58.7	6.3 (55.754)	1700 (3748.5)	1PH7 288 - . . F . . - 0 ■■■■	354	6SE7 033 - 5 ■ K/J60
<ul style="list-style-type: none"> <li>• <b>Drive type:</b><sup>5)</sup> <ul style="list-style-type: none"> <li>Coupling N</li> <li>Coupling R</li> <li>Belt/increased cantilever forces N</li> <li>Belt/increased cantilever forces R</li> </ul> </li> <li>• <b>Vibration sev. grade:</b> <ul style="list-style-type: none"> <li>N</li> <li>R</li> <li>N</li> <li>R</li> </ul> </li> <li>• <b>Shaft and flange accuracy:</b> <ul style="list-style-type: none"> <li>N</li> <li>R</li> <li>N</li> <li>R</li> </ul> </li> </ul>						A		
<ul style="list-style-type: none"> <li>• <b>Shaft end:</b> <ul style="list-style-type: none"> <li>With keyway, half-key balancing</li> <li>With keyway, full-key balancing</li> <li>Without keyway</li> </ul> </li> </ul>						B		
<ul style="list-style-type: none"> <li>• <b>Paint finish:</b> <ul style="list-style-type: none"> <li>Primed</li> <li>Anthracite gray, standard finish (RAL 7016)</li> <li>Anthracite gray, special finish (RAL 7016)</li> </ul> </li> </ul>						E		
<ul style="list-style-type: none"> <li>• <b>Special models:</b> <ul style="list-style-type: none"> <li>Please specify additional order code and any required plain text; see Page 3/3.</li> </ul> </li> </ul>						F		
Converter						A		
Inverter						C		
						J		
						0		
						3		
						6		
						-C30		
						H		
						W		

- $n_1$ : Maximum permissible speed at constant power or speed where for  $P = P_{rated}$ , there is still a 30% power reserve up to the stall limit.
- $n_{S1}$ : Maximum permissible speed that is continuously permitted without speed duty cycles.
- $n_{max}$ : Maximum rotational speed. This speed may not be exceeded! Notice: Due to  $f_{max} < 5 \cdot f_{rated}$ , the maximum rotational speed is sometimes limited to smaller values.

- Notice: The rated converter current is smaller than the rated motor current.
- For possible combinations, refer to page 3/42.

# Servo Motors for SIMOVERT MASTERDRIVES

## Asynchronous Servo Motors

### 1PH7 Motors

#### Selection and Ordering Data with SIMOVERT MASTERDRIVES Motion Control<sup>1)</sup>

Rated Rotational Speed	Shaft Height	Rated Output	Rated Torque	Rated Current	Rated Voltage	Speed during Field Weakening <sup>2)</sup>	Max. Permissible Continuous Speed <sup>3)</sup>	Max. Speed <sup>4)</sup>	1PH7 Asynchronous Motors
$n_{rated}$		$P_{rated}$	$M_{rated}$	$I_{rated}$	$V_{rated}$	$n_1$	$n_{S1}$	$n_{max}$	Order No.
rpm	SH	kW (HP)	Nm (lb <sub>f</sub> -ft)	A	V	rpm	rpm	rpm	
<b>Supply voltage 3-ph. AC 400 V for SIMOVERT MASTERDRIVES Motion Control</b>									
<b>400</b>	160	9.5 (12.74)	227 (2009.2)	30	274	800	800	800	<b>1PH7 163</b> – ■ ■ B ■ ■ – ■ ...
		13 (17.43)	310 (2743.8)	37	294	800	800	800	<b>1PH7 167</b> – ■ ■ B ■ ■ – ■ ...
<b>1000</b>	100	3.7 (5.76)	35 (77.2)	10	343	2000	2000	2000	<b>1PH7 103</b> – ■ ■ D ■ ■ – ■ ...
		6.25 (8.38)	60 (531.1)	17.5	319	2000	2000	2000	<b>1PH7 107</b> – ■ ■ D ■ ■ – ■ ...
	132	12 (16.09)	115 (253.6)	30	336	2000	2000	2000	<b>1PH7 133</b> – ■ ■ D ■ ■ – ■ ...
		17 (22.79)	162 (1433.9)	43	322	2000	2000	2000	<b>1PH7 137</b> – ■ ■ D ■ ■ – ■ ...
	160	22 (29.49)	210 (463.1)	55	315	2000	2000	2000	<b>1PH7 163</b> – ■ ■ D ■ ■ – ■ ...
		28 (37.53)	267 (588.7)	71	312	2000	2000	2000	<b>1PH7 167</b> – ■ ■ D ■ ■ – ■ ...
<b>1500</b>	100	3.7 (4.96)	24 (212.4)	10	350	3000	3000	3000	<b>1PH7 101</b> – ■ ■ F ■ ■ – ■ ...
		5.5 (7.37)	35 (77.2)	13.0	350	2100	3000	3000	<b>1PH7 103</b> – ■ ■ F ■ ■ – ■ ...
		7.0 (9.38)	45 (99.2)	17.5	346	3000	3000	3000	<b>1PH7 105</b> – ■ ■ F ■ ■ – ■ ...
		9.0 (12.06)	57 (125.7)	23.5	336	3000	3000	3000	<b>1PH7 107</b> – ■ ■ F ■ ■ – ■ ...

#### • Separate fan:

- With separate fan
- Without separate fan, for pipe connection
- With separate fan, but with metric cable entries in accordance with EN 50262
- Without separate fan, for pipe connection, but with metric cable entries in accordance with EN 50262

2  
6  
7  
8

#### • Encoder:

- Absolute encoder EnDat 2,048 pulses/revolution
- Incremental encoder sin/cos 1 V<sub>pp</sub> (without C track or D track)
- Incremental encoder sin/cos 1 V<sub>pp</sub> (with C track and D track)
- Resolver, 2-pole

E  
N  
M  
R

#### • Terminal box arrangement/direction of cable entry (drive-end view):

- On top/from right
- On top/from non-drive end
- On top/from left

0  
2  
3

#### • Construction type:

- IM B3 (IM V5, IM V6)
- IM B5 (IM V1, IM V3) available only for shaft height 100 and 132
- IM B35 (IM V15, IM V36)

0  
2  
3

#### • Holding brake with emergency stop function:<sup>5)</sup>

- Without brake
- Brake connection voltage: **230 V AC, 50 to 60 Hz**
- With brake
- With brake (brake includes microswitch)
- With brake (brake includes manual release)
- With brake (brake includes manual release and microswitch)
- Brake connection voltage: **24 V DC**
- With brake
- With brake (brake includes microswitch)
- With brake (brake includes manual release)
- With brake (brake includes manual release and microswitch)

0  
1  
2  
3  
4  
5  
6  
7  
8

For order number supplements for drive type, direction of air flow, and paint finish (positions 14 through 16 of the order no.), see page 3/27.

# Servo Motors for SIMOVERT MASTERDRIVES

## Asynchronous Servo Motors

1PH7 Motors

### Selection and Ordering Data with SIMOVERT MASTERDRIVES Motion Control<sup>1)</sup>

Power Factor	Magnetizing Current $I_{\mu}$ A	Rated Efficiency $\eta_{rated}$	Rated Frequency $f_{rated}$ Hz	Moment of inertia $J$ kgm <sup>2</sup> (lb <sub>f</sub> -in-s <sup>2</sup> )	Weight, approx. kg (lb)	1PH7 Asynchronous Motors	SIMOVERT MASTERDRIVES MC Inverter/Converter Rated Current			
						Order No.	$I_{rated}$ A	Order No.		
<b>Supply voltage 3-ph. AC 400 V for SIMOVERT MASTERDRIVES Motion Control</b>										
0.88	11.5	0.809	14.3	0.185 (1.6372)	175 (385.9)	1PH7 163 - . . . B . . . . . ■ ■ ■ ■	34	6SE7 023 - 4 EP50		
0.88	14	0.814	14.3	0.228 (2.0178)	210 (463.1)	1PH7 167 - . . . B . . . . . ■ ■ ■ ■	37.5	6SE7 023 - 8 ■ D51		
0.82	4.8	0.794	35.6	0.017 (0.1504)	40 (88.2)	1PH7 103 - . . . D . . . . . ■ ■ ■ ■	10	6SE7 021 - 0 ■ P50		
0.81	8.9	0.822	35.3	0.029 (0.2566)	65 (143.3)	1PH7 107 - . . . D . . . . . ■ ■ ■ ■	20.5	6SE7 022 - 1 EP50		
0.86	13	0.865	34.8	0.076 (0.6726)	90 (198.5)	1PH7 133 - . . . D . . . . . ■ ■ ■ ■	34	6SE7 023 - 4 EP50		
0.86	19	0.878	34.6	0.109 (0.9646)	150 (330.8)	1PH7 137 - . . . D . . . . . ■ ■ ■ ■	47	6SE7 024 - 7 ■ D51		
0.85	24	0.899	34.2	0.185 (1.6372)	175 (385.9)	1PH7 163 - . . . D . . . . . ■ ■ ■ ■	59	6SE7 026 - 0 ■ D51		
0.84	33	0.903	34.2	0.228 (2.0178)	210 (463.1)	1PH7 167 - . . . D . . . . . ■ ■ ■ ■	72	6SE7 027 - 2 ■ D51		
0.74	5.9	0.847	51.6	0.017 (0.1504)	40 (88.2)	1PH7 101 - . . . F . . . . . ■ ■ ■ ■	10	6SE7 021 - 0 ■ P50		
0.84	5.4	0.832	52.7	0.017 (0.1504)	40 (88.2)	1PH7 103 - . . . F . . . . . ■ ■ ■ ■	14	6SE7 021 - 4 EP50		
0.78	9.4	0.866	51.7	0.029 (0.2566)	65 (143.3)	1PH7 105 - . . . F . . . . . ■ ■ ■ ■	20.5	6SE7 022 - 1 EP50		
0.80	11	0.859	52.0	0.029 (0.2566)	65 (143.3)	1PH7 107 - . . . F . . . . . ■ ■ ■ ■	27	6SE7 022 - 7 EP50		
<b>• Drive type:</b> Coupling and belt R Coupling and belt S Coupling and belt SR Coupling and belt N						<b>• Vibration sev. grade:</b> R R R N (only in connection with brake attachment)			<b>• Shaft and flange accuracy:</b> B C D K	
<b>• Direction of air flow:</b> DE → NDE NDE → DE <sup>7)</sup> DE → NDE NDE → DE <sup>7)</sup> DE → NDE NDE → DE <sup>7)</sup>						<b>• Shaft end:</b> With keyway, half-key balancing With keyway, half-key balancing With keyway, full-key balancing With keyway, full-key balancing Keyless Keyless			A B C D J K	
<b>• Paint finish:</b> None None, flange and radial shaft sealing ring <sup>6)</sup> Anthracite gray, standard finish (RAL 7016) Anthracite gray, standard finish (RAL 7016), flange and radial shaft sealing ring <sup>6)</sup> Anthracite gray, special finish (RAL 7016) Anthracite gray, special finish (RAL 7016), flange and radial shaft sealing ring <sup>6)</sup>									0 2 3 5 6 8	
<b>• Special models:</b> Please specify additional order code and any required plain text; see Page 3/3.									-Z	
Converter Inverter									E T	

- For rated currents < 37.5 A, Compact PLUS devices are assigned.
- $n_1$ : Maximum permissible speed at constant power or speed where for  $P = P_{rated}$ , there is still a 30% power reserve up to the stall limit.
- $n_{S1}$ : Maximum permissible speed that is continuously permitted without speed duty cycles.
- $n_{max}$ : Maximum rotational speed. This speed may not be exceeded! Notice: Due to  $f_{max.} < 2 \cdot f_{rated}$ , the maximum rotational speed is sometimes limited to smaller values.
- For model with brake: 12th position in ordering no. is "2" or "3"; 14th position is "K"; 15th position is "A", "B", "J" or "K"; 16th position "0", "3" or "6".
- Model prepared for ZF gearbox attachment: 12th data position is "2" or "3"; 13th position is "0"; 14th position is "B", 15th position is "C" or "D"; 16th position is "2", "5" or "8". Stagnant fluids are not permitted at the shaft exit.
- Preferred air flow direction in contaminated environments.

3

# Servo Motors for SIMOVERT MASTERDRIVES

## Asynchronous Servo Motors

### 1PH7 Motors

#### Selection and Ordering Data with SIMOVERT MASTERDRIVES Motion Control<sup>1)</sup> (continued)

Rated Rotational Speed	Shaft Height	Rated Output	Rated Torque	Rated Current	Rated Voltage	Speed during Field Weakening <sup>2)</sup>	Max. Permissible Continuous Speed <sup>3)</sup>	Max. Speed <sup>4)</sup>	1PH7 Asynchronous Motors
$n_{rated}$		$P_{rated}$	$M_{rated}$	$I_{rated}$	$V_{rated}$	$n_1$	$n_{S1}$	$n_{max}$	Order No.
rpm	SH	kW (HP)	Nm (lb <sub>f</sub> -ft)	A	V	rpm	rpm	rpm	
<b>Supply voltage 3-ph. AC 400 V for SIMOVERT MASTERDRIVES Motion Control</b>									
<b>1500</b>	132	11 (14.75)	70 (154.3)	24	350	3000	3000	3000	<b>1PH7 131</b> – ■ ■ F ■ ■ – ■ ...
		15 (20.11)	96 (211.7)	34	346	3000	3000	3000	<b>1PH7 133</b> – ■ ■ F ■ ■ – ■ ...
		18.5 (24.8)	118 (260.2)	42	350	3000	3000	3000	<b>1PH7 135</b> – ■ ■ F ■ ■ – ■ ...
		22 (29.49)	140 (308.7)	57	308	3000	3000	3000	<b>1PH7 137</b> – ■ ■ F ■ ■ – ■ ...
	160	30 (40.21)	191 (421.2)	72	319	3000	3000	3000	<b>1PH7 163</b> – ■ ■ F ■ ■ – ■ ...
		37 (49.6)	236 (520.4)	82	350	2800	3000	3000	<b>1PH7 167</b> – ■ ■ F ■ ■ – ■ ...
<b>2000</b>	100	7 (9.38)	33 (72.8)	17.5	343	4000	4000	4000	<b>1PH7 103</b> – ■ ■ G ■ ■ – ■ ...
		10.5 (14.08)	50 (442.6)	26	350	4000	4000	4000	<b>1PH7 107</b> – ■ ■ G ■ ■ – ■ ...
	132	20 (26.81)	96 (211.7)	45	350	3900	4000	4000	<b>1PH7 133</b> – ■ ■ G ■ ■ – ■ ...
		28 (37.53)	134 (295.5)	60	350	3800	4000	4000	<b>1PH7 137</b> – ■ ■ G ■ ■ – ■ ...
	160	36 (48.26)	172 (379.3)	85	333	3000	3700	4000	<b>1PH7 163</b> – ■ ■ G ■ ■ – ■ ...
		41 (54.96)	196 (432.2)	89	350	2800	3700	4000	<b>1PH7 167</b> – ■ ■ G ■ ■ – ■ ...

#### • Separate fan:

- With separate fan
- Without separate fan, for pipe connection
- With separate fan, but with metric cable entries in accordance with EN 50262
- Without separate fan, for pipe connection, but with metric cable entries in accordance with EN 50262

2  
6  
7  
8

#### • Encoder:

- Absolute encoder EnDat 2,048 pulses/revolution
- Incremental encoder sin/cos 1 V<sub>pp</sub> (without C track or D track)
- Incremental encoder sin/cos 1 V<sub>pp</sub> (with C track and D track)
- Resolver, 2-pole

E  
N  
M  
R

#### • Terminal box arrangement/direction of cable entry (drive-end view):

- On top/from right
- On top/from non-drive end
- On top/from left

0  
2  
3

#### • Construction type:

- IM B3 (IM V5, IM V6)
- IM B5 (IM V1, IM V3) available only for shaft height 100 and 132
- IM B35 (IM V15, IM V36)

0  
2  
3

#### • Holding brake with emergency stop function:<sup>5)</sup>

- Without brake
- Brake connection voltage: **230 V AC, 50 to 60 Hz**
- With brake
- With brake (brake includes microswitch)
- With brake (brake includes manual release)
- With brake (brake includes manual release and microswitch)
- Brake connection voltage: **24 V DC**
- With brake
- With brake (brake includes microswitch)
- With brake (brake includes manual release)
- With brake (brake includes manual release and microswitch)

0  
1  
2  
3  
4  
5  
6  
7  
8

For order number supplements for drive type, direction of air flow, and paint finish (positions 14 through 16 of the order no.), see page 3/29.



# Servo Motors for SIMOVERT MASTERDRIVES

## Asynchronous Servo Motors

1PH7 Motors

### Selection and Ordering Data with SIMOVERT MASTERDRIVES Motion Control<sup>1)</sup>

Power Factor	Magnetizing Current $I_{\mu}$	Rated Efficiency $\eta_{rated}$	Rated Frequency $f_{rated}$	Moment of inertia $J$	Weight, approx. kg (lb)	1PH7 Asynchronous Motors		SIMOVERT MASTERDRIVES MC	
						Order No.	$I_{rated}$	Inverter/Converter Rated Current	Order No.
$\cos \varphi$	A		Hz	$\text{kgm}^2$ ( $\text{lb}_f\text{-in-s}^2$ )			A		
<b>Supply voltage 3-ph. AC 400 V for SIMOVERT MASTERDRIVES Motion Control</b>									
0.88	8.4	0.896	51.3	0.076 (0.6726)	90 (198.5)	1PH7 131 - . . . F . . . . .	27	6SE7 022 - 7 EP50	
0.85	14	0.895	51.3	0.076 (0.6726)	90 (198.5)	1PH7 133 - . . . F . . . . .	34	6SE7 023 - 4 EP50	
0.85	17	0.902	51.1	0.109 (0.9646)	150 (330.8)	1PH7 135 - . . . F . . . . .	47	6SE7 024 - 7 D51	
0.85	23	0.900	51.2	0.109 (0.9646)	150 (330.8)	1PH7 137 - . . . F . . . . .	59	6SE7 026 - 0 D51	
0.85	30	0.912	50.9	0.185 (1.6372)	175 (385.9)	1PH7 163 - . . . F . . . . .	72	6SE7 027 - 2 D51	
0.86	32	0.916	50.8	0.228 (2.0178)	210 (463.1)	1PH7 167 - . . . F . . . . .	92	6SE7 031 - 0 E50	
0.80	8.3	0.857	68.9	0.017 (0.1504)	40 (88.2)	1PH7 103 - . . . G . . . . .	20.5	6SE7 021 - 1 EP50	
0.80	12	0.869	68.6	0.029 (0.2566)	65 (143.3)	1PH7 107 - . . . G . . . . .	27	6SE7 022 - 7 EP50	
0.86	18	0.898	68.0	0.076 (0.6726)	90 (198.5)	1PH7 133 - . . . G . . . . .	47	6SE7 024 - 7 D51	
0.88	21	0.903	68.0	0.109 (0.9646)	150 (330.8)	1PH7 137 - . . . G . . . . .	59	6SE7 027 - 3 D51	
0.84	37	0.906	67.5	0.185 (1.6372)	175 (385.9)	1PH7 163 - . . . G . . . . .	92	6SE7 031 - 0 E50	
0.84	40	0.907	67.4	0.228 (2.0178)	210 (463.1)	1PH7 167 - . . . G . . . . .	92	6SE7 031 - 0 E50	
<b>• Drive type:</b> Coupling and belt R Coupling and belt S Coupling and belt SR Coupling and belt N						<b>• Vibration sev. grade:</b> R R R N (only in connection with brake attachment)		<b>• Shaft and flange accuracy:</b> B C D K	
<b>• Direction of air flow:</b> DE → NDE NDE → DE <sup>7)</sup> DE → NDE NDE → DE <sup>7)</sup> DE → NDE NDE → DE <sup>7)</sup>						<b>• Shaft end:</b> With keyway, half-key balancing With keyway, half-key balancing With keyway, full-key balancing With keyway, full-key balancing Keyless Keyless		A B C D J K	
<b>• Paint finish:</b> None None, flange and radial shaft sealing ring <sup>6)</sup> Anthracite gray, standard finish (RAL 7016) Anthracite gray, standard finish (RAL 7016), flange and radial shaft sealing ring <sup>6)</sup> Anthracite gray, special finish (RAL 7016) Anthracite gray, special finish (RAL 7016), flange and radial shaft sealing ring <sup>6)</sup>						0 2 3 5 6 8			
<b>• Special models:</b> Please specify additional order code and any required plain text; see Page 3/3.						-Z			
Converter Inverter								E T	

1) For rated currents < 37.5 A, Compact PLUS devices are assigned.  
 2)  $n_1$ : Maximum permissible speed at constant power or speed where for  $P = P_{rated}$ , there is still a 30% power reserve up to the stall limit.  
 3)  $n_{S1}$ : Maximum permissible speed that is continuously permitted without speed duty cycles.  
 4)  $n_{max}$ : Maximum rotational speed. This speed may not be exceeded! Notice: Due to  $f_{max.} < 2 \cdot f_{rated}$ , the maximum rotational speed is sometimes limited to smaller values.  
 5) For model with brake: 12th position in ordering no. is "2" or "3"; 14th position is "K"; 15th position is "A", "B", "J" or "K"; 16th position "0", "3" or "6".  
 6) Model prepared for ZF gearbox attachment: 12th data position is "2" or "3"; 13th position is "0"; 14th position is "B", 15th position is "C" or "D"; 16th position is "2", "5" or "8". Stagnant fluids are not permitted at the shaft exit.  
 7) Preferred air flow direction in contaminated environments.



# Servo Motors for SIMOVERT MASTERDRIVES

## Asynchronous Servo Motors

### 1PH7 Motors

#### Selection and Ordering Data with SIMOVERT MASTERDRIVES Motion Control

Rated Rotational Speed	Shaft Height	Rated Output	Rated Torque <sup>1)</sup>	Rated Current	Rated Voltage	Speed during Field Weakening <sup>1)</sup>	Max. Permissible Continuous Speed <sup>2)</sup>	Max. Speed <sup>3)</sup>	1PH7 Asynchronous Motors
$n_{rated}$		$P_{rated}$	$M_{rated}$	$I_{rated}$	$V_{rated}$	$n_1$	$n_{S1}$	$n_{max}$	Order No.
rpm	SH	kW (HP)	Nm (lb <sub>f</sub> -ft)	A	V	rpm	rpm	rpm	
<b>Supply voltage 3-ph. AC 400 V for SIMOVERT MASTERDRIVES Motion Control</b>									
<b>400</b>	180	16.3 (21.85)	390 (287.7)	51	271	800	800	800	<b>1PH7 184</b> – ■ ■ B ■ ■ – ■ ...
		21.2 (28.42)	505 (372.5)	67	268	800	800	800	<b>1PH7 186</b> – ■ ■ B ■ ■ – ■ ...
	225	30.4 (40.75)	725 (534.8)	88	268	800	800	800	<b>1PH7 224</b> – ■ ■ B ■ ■ – ■ ...
		39.2 (52.55)	935 (689.7)	114	264	800	800	800	<b>1PH7 226</b> – ■ ■ B ■ ■ – ■ ...
		48 (64.34)	1145 (844.6)	136	272	800	800	800	<b>1PH7 228</b> – ■ ■ B ■ ■ – ■ ...
<b>1000</b>	180	39 (52.28)	372 (820.3)	90	335	2000	2000	2000	<b>1PH7 184</b> – ■ ■ D ■ ■ – ■ ...
		51 (68.36)	485 (1069.4)	116	340	2000	2000	2000	<b>1PH7 186</b> – ■ ■ D ■ ■ – ■ ...
	225	71 (95.17)	678 (1495)	161	335	2000	2000	2000	<b>1PH7 224</b> – ■ ■ D ■ ■ – ■ ...
		92 (123.32)	880 (1940.4)	198	340	2000	2000	2000	<b>1PH7 226</b> – ■ ■ D ■ ■ – ■ ...
		113 (151.47)	1080 (2381.4)	240	340	2000	2000	2000	<b>1PH7 228</b> – ■ ■ D ■ ■ – ■ ...

#### • Separate fan:

- With separate fan
- Without separate fan, for pipe connection
- With separate fan, but with metric cable entries in accordance with EN 50262
- Without separate fan, for pipe connection, but with metric cable entries in accordance with EN 50262

2  
6  
7  
8

#### • Encoder:

- Absolute encoder EnDat 2,048 pulses/revolution
- Incremental encoder sin/cos 1  $V_{pp}$  (without C track or D track)
- Incremental encoder sin/cos 1  $V_{pp}$  (with C track and D track)
- Resolver, 2-pole

E  
N  
M  
R

#### • Terminal box arrangement/direction of cable entry (drive-end view):

- On top/from right
- On top/from drive end
- On top/from non-drive end
- On top/from left

0  
1  
2  
3

#### • Construction type:

- IM B3
  - IM B3
  - IM B35 (only for 1PH7 184 with flange A 400)
  - IM B35 (only for 1PH7 184 with flange A 450)
  - IM B35 (for 1PH7 186 with flange A 450 and 1PH7 22. with flange A 550)
  - IM B35 (only for 1PH7 184 with flange A 400)
  - IM B35 (only for 1PH7 184 with flange A 450)
  - IM B35 (for 1PH7 186 with flange A 450 and 1PH7 22. with flange A 550)
- Hoisting concept for other construction types (IM B6, IM B7, IM B8, IM V5, IM V6)
- Hoisting concept for other construction types (IM V15, IM V36)
- Hoisting concept for other construction types (IM V15, IM V36)
- Hoisting concept for other construction types (IM V15, IM V36)

0  
1  
3  
4  
3  
5  
6  
5

#### • Holding brake with emergency stop function (suitable for IM B3 coupling drive)<sup>4)</sup>:

- Without brake
- With brake (brake includes emergency release screws and microswitch)
- With brake (brake includes manual release and microswitch)

0  
2  
4

For order number supplements for drive type, direction of air flow, and paint finish (positions 14 through 16 of the order no.), see page 3/31.

# Servo Motors for SIMOVERT MASTERDRIVES

## Asynchronous Servo Motors

1PH7 Motors

### Selection and Ordering Data with SIMOVERT MASTERDRIVES Motion Control

Power Factor	Magnetizing Current $I_{\mu}$ A	Rated Efficiency $\eta_{rated}$	Rated Frequency $f_{rated}$ Hz	Moment of inertia $J$ kgm <sup>2</sup> (lb <sub>f</sub> -in-s <sup>2</sup> )	Weight, approx. kg (lb)	1PH7 Asynchronous Motors	SIMOVERT MASTERDRIVES MC	
						Order No.	Inverter/Converter Rated Current $I_{rated}$ A	Order No.
<b>Supply voltage 3-ph. AC 400 V for SIMOVERT MASTERDRIVES Motion Control</b>								
0.84	26	0.830	14.2	0.503 (4.4545)	370 (815.8)	1PH7 184 - . . . B . . . . ■■■■	59	6SE7 026 - 0 ■ D51
0.81	38.5	0.845	14.0	0.666 (5.894)	440 (970.2)	1PH7 186 - . . . B . . . . ■■■■	72	6SE7 027 - 2 ■ D51
0.87	36.5	0.864	14.0	1.479 (13.0889)	630 (1389.2)	1PH7 224 - . . . B . . . . ■■■■	92	6SE7 031 - 0 ■ E50
0.86	49	0.880	14.0	1.930 (17.0802)	750 (1653.8)	1PH7 226 - . . . B . . . . ■■■■	124	6SE7 031 - 2 ■ F50
0.85	60.5	0.888	13.9	2.326 (20.5848)	860 (1896.3)	1PH7 228 - . . . B . . . . ■■■■	155	6SE7 031 - 8 ■ F50
0.83	44	0.913	34.2	0.503 (4.4545)	370 (815.8)	1PH7 184 - . . . D . . . . ■■■■	92	6SE7 031 - 0 ■ E50
0.81	58	0.918	34.1	0.666 (5.894)	440 (970.2)	1PH7 186 - . . . D . . . . ■■■■	124	6SE7 031 - 2 ■ F50
0.81	78.5	0.934	33.9	1.479 (13.0889)	630 (1389.2)	1PH7 224 - . . . D . . . . ■■■■	175	6SE7 032 - 1 ■ G50
0.84	87.5	0.935	33.9	1.930 (17.0802)	750 (1653.8)	1PH7 226 - . . . D . . . . ■■■■	218	6SE7 032 - 6 ■ G50
0.85	98	0.938	33.9	2.326 (20.5848)	860 (1896.3)	1PH7 228 - . . . D . . . . ■■■■	262	6SE7 033 - 2 ■ G50
<ul style="list-style-type: none"> <li><b>Drive type:</b> <ul style="list-style-type: none"> <li>Coupling R</li> <li>Coupling R</li> <li>Coupling S</li> <li>Coupling SR</li> <li>Belt R</li> <li>Belt R</li> <li>Increased cantilever forces R</li> <li>Increased cantilever forces R</li> </ul> </li> <li><b>Vibration sev. grade:</b> <ul style="list-style-type: none"> <li>R</li> <li>R</li> <li>R</li> <li>R</li> <li>R</li> <li>R</li> <li>R</li> <li>R</li> </ul> </li> <li><b>Shaft and flange accuracy:</b> <ul style="list-style-type: none"> <li>N</li> <li>R</li> <li>R</li> <li>R</li> <li>N</li> <li>R</li> <li>N</li> <li>R</li> </ul> </li> </ul>						A		
<ul style="list-style-type: none"> <li><b>Direction of air flow:</b> <ul style="list-style-type: none"> <li>DE → NDE</li> <li>NDE → DE<sup>6)</sup></li> <li>DE → NDE</li> <li>NDE → DE<sup>6)</sup></li> <li>DE → NDE</li> <li>NDE → DE<sup>6)</sup></li> </ul> </li> <li><b>Shaft end:</b> <ul style="list-style-type: none"> <li>With keyway, half-key balancing</li> <li>With keyway, half-key balancing</li> <li>With keyway, full-key balancing</li> <li>With keyway, full-key balancing</li> <li>Without keyway</li> <li>Without keyway</li> </ul> </li> </ul>						B		
<ul style="list-style-type: none"> <li><b>Paint finish:</b> <ul style="list-style-type: none"> <li>Primed</li> <li>Primed, prepared for ZF gearbox attachment<sup>5)</sup></li> <li>Anthracite gray, standard finish (RAL 7016)</li> <li>Anthracite gray, standard finish (RAL 7016), prepared for ZF gearbox attachment<sup>5)</sup></li> <li>Anthracite gray, special finish (RAL 7016)</li> <li>Anthracite gray, special finish (RAL 7016), prepared for ZF gearbox attachment<sup>5)</sup></li> </ul> </li> </ul>						C		
<ul style="list-style-type: none"> <li><b>Special models:</b> <ul style="list-style-type: none"> <li>Please specify additional order code and any required plain text; see Page 3/3.</li> </ul> </li> </ul>						D		
<ul style="list-style-type: none"> <li>Converter</li> <li>Inverter</li> </ul>						E	T	

- $n_1$ : Maximum permissible speed at constant power or speed where for  $P = P_{rated}$ , there is still a 30% power reserve up to the stall limit.
- $n_{S1}$ : Maximum permissible speed that is continuously permitted without speed duty cycles.
- $n_{max}$ : Maximum rotational speed. This speed may not be exceeded! Notice: Due to  $f_{max} < 2 \cdot f_{rated}$ , the maximum rotational speed is sometimes limited to smaller values.
- For model with brake: 12th data position "0", 14th and 15th position "A", 16th position "0", "3" or "6".
- Model prepared for ZF gearbox attachment: Only for types 1PH7 184, 186, and 224, 12th data position is "3" or "5", 13th is "0"; 14th is "B"; 15th is "C"; 16th is "2", "5" or "8". Stagnant fluids are not permitted at the shaft exit.
- Preferred air flow direction in contaminated environments.

# Servo Motors for SIMOVERT MASTERDRIVES

## Asynchronous Servo Motors

### 1PH7 Motors

#### Selection and Ordering Data with SIMOVERT MASTERDRIVES Motion Control (continued)

Rated Rotational Speed	Shaft Height	Rated Output	Rated Torque <sup>1)</sup>	Rated Current	Rated Voltage	Speed during Field Weakening <sup>1)</sup>	Max. Permissible Continuous Speed <sup>2)</sup>	Max. Speed <sup>3)</sup>	1PH7 Asynchronous Motors
$n_{rated}$		$P_{rated}$	$M_{rated}$	$I_{rated}$	$V_{rated}$	$n_1$	$n_{S1}$	$n_{max}$	Order No.
rpm	SH	kW (HP)	Nm (lb <sub>f</sub> -ft)	A	V	rpm	rpm	rpm	
<b>Supply voltage 3-ph. AC 400 V for SIMOVERT MASTERDRIVES Motion Control</b>									
<b>1500</b>	180	51 (68.36)	325 (716.6)	120	335	3000	3000	3000	<b>1PH7 184</b> – ■ ■ F ■ ■ – ■ ...
		74 (99.2)	471 (1038.6)	170	330	3000	3000	3000	<b>1PH7 186</b> – ■ ■ F ■ ■ – ■ ...
	225	95 (127.35)	605 (1334)	204	340	2900	3000 <sup>4)</sup>	3000	<b>1PH7 224</b> – ■ ■ U ■ ■ – ■ ...
		130 (174.26)	828 (1825.7)	278	340	2900	3000 <sup>4)</sup>	3000	<b>1PH7 226</b> – ■ ■ F ■ ■ – ■ ...
		160 (214.48)	1019 (2246.9)	350	340	2900	3000 <sup>4)</sup>	3000	<b>1PH7 228</b> – ■ ■ F ■ ■ – ■ ...
<b>2500</b>	180	78 (104.56)	298 (657.1)	171	340	5000	3500 <sup>4)</sup>	5000	<b>1PH7 184</b> – ■ ■ L ■ ■ – ■ ...
		106 (142.09)	405 (893)	235	335	5000	3500 <sup>4)</sup>	5000	<b>1PH7 186</b> – ■ ■ L ■ ■ – ■ ...
	225	142 (190.35)	542 (1195.1)	298	340	3500	3100 <sup>4)</sup>	4500	<b>1PH7 224</b> – ■ ■ L ■ ■ – ■ ...
		168 (225.2)	642 (1415.6)	362	335	3500	3100 <sup>4)</sup>	4500	<b>1PH7 226</b> – ■ ■ L ■ ■ – ■ ...
		205 (274.8)	783 (1726.5)	433	340	3500	3100 <sup>4)</sup>	4500 <sup>4)</sup>	<b>1PH7 228</b> – ■ ■ L ■ ■ – ■ ...

**• Separate fan:**

- With separate fan
- Without separate fan, for pipe connection
- With separate fan, but with metric cable entries in accordance with EN 50262
- Without separate fan, for pipe connection, but with metric cable entries in accordance with EN 50262

2  
6  
7  
8

**• Encoder:**

- Absolute encoder EnDat 2,048 pulses/revolution
- Incremental encoder sin/cos 1  $V_{pp}$  (without C track or D track)
- Incremental encoder sin/cos 1  $V_{pp}$  (with C track and D track)
- Resolver, 2-pole

E  
N  
M  
R

**• Terminal box arrangement/direction of cable entry (drive-end view):**

- On top/from right
- On top/from drive end
- On top/from non-drive end
- On top/from left

0  
1  
2  
3

**• Construction type:**

- IM B3
  - IM B3
  - IM B35 (only for 1PH7 184 with flange A 400)
  - IM B35 (only for 1PH7 184 with flange A 450)
  - IM B35 (for 1PH7 186 with flange A 450 and 1PH7 22. with flange A 550)
  - IM B35 (only for 1PH7 184 with flange A 400)
  - IM B35 (only for 1PH7 184 with flange A 450)
  - IM B35 (for 1PH7 186 with flange A 450 and 1PH7 22. with flange A 550)
- Hoisting concept for other construction types (IM B6, IM B7, IM B8, IM V5, IM V6)
- Hoisting concept for other construction types (IM V15, IM V36)
- Hoisting concept for other construction types (IM V15, IM V36)
- Hoisting concept for other construction types (IM V15, IM V36)

0  
1  
3  
4  
3  
5  
6  
5

**• Holding brake with emergency stop function (suitable for IM B3 coupling drive)<sup>5)</sup>:**

- Without brake
- With brake (brake includes emergency release screws and microswitch)
- With brake (brake includes manual release and microswitch)

0  
2  
4

For order number supplements for drive type, direction of air flow, and paint finish (positions 14 through 16 of the order no.), see page 3/33.

# Servo Motors for SIMOVERT MASTERDRIVES

## Asynchronous Servo Motors

1PH7 Motors

### Selection and Ordering Data with SIMOVERT MASTERDRIVES Motion Control (continued)

Power Factor	Magnetizing Current $I_{\mu}$ A	Rated Efficiency $\eta_{rated}$	Rated Frequency $f_{rated}$ Hz	Moment of inertia $J$ kgm <sup>2</sup> (lb <sub>f</sub> -in-s <sup>2</sup> )	Weight, approx. kg (lb)	1PH7 Asynchronous Motors	SIMOVERT MASTERDRIVES MC Inverter/Converter Rated Current	
						Order No.	$I_{rated}$ A	Order No.
<b>Supply voltage 3-ph. AC 400 V for SIMOVERT MASTERDRIVES Motion Control</b>								
0.78	64	0.930	50.7	0.503 (4.4545)	370 (815.8)	1PH7 184 - . . . F . . . . ■■■■	124	6SE7 031 - 2 ■ F50
0.81	84	0.937	50.7	0.666 (5.894)	440 (970.2)	1PH7 186 - . . . F . . . . ■■■■	175	6SE7 032 - 1 ■ G50
0.84	88.5	0.944	50.6	1.479 (13.0889)	630 (1389.2)	1PH7 224 - . . . U . . . . ■■■■	218	6SE7 032 - 6 ■ G50
0.84	120	0.945	50.6	1.930 (17.0802)	750 (1653.8)	1PH7 226 - . . . F . . . . ■■■■	308	6SE7 033 - 7 ■ G50
0.82	169	0.949	50.5	2.326 (20.5848)	860 (1896.3)	1PH7 228 - . . . F . . . . ■■■■	423	6SE7 035 - 1 E K50
0.82	77	0.937	84.1	0.503 (4.4545)	370 (815.8)	1PH7 184 - . . . L . . . . ■■■■	175	6SE7 032 - 1 ■ G50
0.82	108	0.942	84.1	0.666 (5.894)	440 (970.2)	1PH7 186 - . . . L . . . . ■■■■	262	6SE7 033 - 2 ■ G50
0.84	115	0.948	84.0	1.479 (13.0889)	630 (1389.2)	1PH7 224 - . . . L . . . . ■■■■	308	6SE7 033 - 7 ■ G50
0.84	154	0.95	84.0	1.930 (17.0802)	750 (1653.8)	1PH7 226 - . . . L . . . . ■■■■	423	6SE7 035 - 1 E K50
0.84	185	0.95	83.9	2.326 (20.5848)	860 (1896.3)	1PH7 228 - . . . L . . . . ■■■■	491	6SE7 036 - 0 E K50
<ul style="list-style-type: none"> <li><b>Drive type:</b> <ul style="list-style-type: none"> <li>Coupling R</li> <li>Coupling R</li> <li>Coupling S</li> <li>Coupling SR</li> <li>Belt R</li> <li>Belt R</li> <li>Increased cantilever forces R</li> <li>Increased cantilever forces R</li> </ul> </li> <li><b>Vibration sev. grade:</b> <ul style="list-style-type: none"> <li>R</li> <li>R</li> <li>R</li> <li>R</li> <li>N</li> <li>R</li> <li>N</li> <li>R</li> </ul> </li> <li><b>Shaft and flange accuracy:</b> <ul style="list-style-type: none"> <li>N</li> <li>R</li> <li>R</li> <li>R</li> <li>N</li> <li>R</li> <li>N</li> <li>R</li> </ul> </li> </ul>						A B C D E F G H		
<ul style="list-style-type: none"> <li><b>Direction of air flow:</b> <ul style="list-style-type: none"> <li>DE → NDE</li> <li>NDE → DE<sup>7)</sup></li> <li>DE → NDE</li> <li>NDE → DE<sup>7)</sup></li> <li>DE → NDE</li> <li>NDE → DE<sup>7)</sup></li> </ul> </li> <li><b>Shaft end:</b> <ul style="list-style-type: none"> <li>With keyway, half-key balancing</li> <li>With keyway, half-key balancing</li> <li>With keyway, full-key balancing</li> <li>With keyway, full-key balancing</li> <li>Without keyway</li> <li>Without keyway</li> </ul> </li> </ul>						A B C D J K		
<ul style="list-style-type: none"> <li><b>Paint finish:</b> <ul style="list-style-type: none"> <li>Primed</li> <li>Primed, prepared for ZF gearbox attachment<sup>6)</sup></li> <li>Anthracite gray, standard finish (RAL 7016)</li> <li>Anthracite gray, standard finish (RAL 7016), prepared for ZF gearbox attachment<sup>6)</sup></li> <li>Anthracite gray, special finish (RAL 7016)</li> <li>Anthracite gray, special finish (RAL 7016), prepared for ZF gearbox attachment<sup>6)</sup></li> </ul> </li> </ul>						0 2 3 5 6 8		
<ul style="list-style-type: none"> <li><b>Special models:</b> Please specify additional order code and any required plain text; see Page 3/3.</li> </ul>						-Z		
Converter Inverter						E T		

- $n_1$ : Maximum permissible speed at constant power or speed where for  $P = P_{rated}$ , there is still a 30% power reserve up to the stall limit.
- $n_{S1}$ : Maximum permissible speed that is continuously permitted without speed duty cycles.
- $n_{max}$ : Maximum rotational speed. This speed may not be exceeded! Notice: Due to  $f_{max} < 2 \cdot f_{rated}$ , the maximum rotational speed is sometimes limited to smaller values.
- Rotational speed is reduced in the event of increased cantilever forces, see Part 7.
- For model with brake: 12th data position "0", 14th and 15th position "A", 16th position "0", "3" or "6".
- Model prepared for ZF gearbox attachment: Only for types 1PH7 184, 186, and 224, 12th data position is "3" or "5", 13th is "0"; 14th is "B"; 15th is "C"; 16th is "2", "5" or "8". Stagnant fluids are not permitted at the shaft exit.
- Preferred air flow direction in contaminated environments.

# Servo Motors for SIMOVERT MASTERDRIVES

## Asynchronous Servo Motors

### 1PH7 Motors

#### Selection and Ordering Data with SIMOVERT MASTERDRIVES Motion Control<sup>1)</sup>

Rated Rotational Speed	Shaft Height	Rated Output	Rated Torque	Rated Current	Rated Voltage	Speed during Field Weakening <sup>2)</sup>	Max. Permissible Continuous Speed <sup>3)</sup>	Max. Speed <sup>4)</sup>	1PH7 Asynchronous Motors
$n_{rated}$		$P_{rated}$	$M_{rated}$	$I_{rated}$	$V_{rated}$	$n_1$	$n_{S1}$	$n_{max}$	Order No.
rpm	SH	kW (HP)	Nm (lb <sub>f</sub> -ft)	A	V	rpm	rpm	rpm	
<b>Supply voltage 3-ph. AC 480 V for SIMOVERT MASTERDRIVES Motion Control</b>									
<b>400</b>	160	9.5 (12.74)	227 (2009.2)	30	274	800	800	800	<b>1PH7 163</b> – ■ ■ B ■ ■ – ■ ...
		13 (17.43)	310 (2743.8)	37	294	800	800	800	<b>1PH7 167</b> – ■ ■ B ■ ■ – ■ ...
<b>1150</b>	100	4.3 (5.76)	36 (26.6)	10	391	2200	2300	2300	<b>1PH7 103</b> – ■ ■ D ■ ■ – ■ ...
		7.2 (9.65)	60 (44.3)	17.5	360	2300	2300	2300	<b>1PH7 107</b> – ■ ■ D ■ ■ – ■ ...
	132	13.5 (18.1)	112 (82.6)	29	381	2300	2300	2300	<b>1PH7 133</b> – ■ ■ D ■ ■ – ■ ...
		19.5 (26.14)	162 (119.5)	43	367	2300	2300	2300	<b>1PH7 137</b> – ■ ■ D ■ ■ – ■ ...
	160	25 (33.51)	208 (153.4)	55	364	2300	2300	2300	<b>1PH7 163</b> – ■ ■ D ■ ■ – ■ ...
		31 (41.55)	257 (189.6)	70	357	2300	2300	2300	<b>1PH7 167</b> – ■ ■ D ■ ■ – ■ ...
<b>1750</b>	100	4.3 (5.76)	24 (212.4)	10	398	3500	3500	3500	<b>1PH7 101</b> – ■ ■ F ■ ■ – ■ ...
		6.25 (8.38)	34 (25.1)	13.0	398	2600	3500	3500	<b>1PH7 103</b> – ■ ■ F ■ ■ – ■ ...
		8 (10.72)	44 (32.5)	17.5	398	3500	3500	3500	<b>1PH7 105</b> – ■ ■ F ■ ■ – ■ ...
		10 (13.4)	55 (40.6)	23	381	3500	3500	3500	<b>1PH7 107</b> – ■ ■ F ■ ■ – ■ ...

- Separate fan:**
  - With separate fan
  - Without separate fan, for pipe connection
  - With separate fan, but with metric cable entries in accordance with EN 50262
  - Without separate fan, for pipe connection, but with metric cable entries in accordance with EN 50262

2  
6  
7  
8

- Encoder:**
  - Absolute encoder EnDat 2,048 pulses/revolution
  - Incremental encoder sin/cos 1  $V_{pp}$  (without C track or D track)
  - Incremental encoder sin/cos 1  $V_{pp}$  (with C track and D track)
  - Resolver, 2-pole

E  
N  
M  
R

- Terminal box arrangement/direction of cable entry (drive-end view):**

On top/from right  
On top/from non-drive end  
On top/from left

0  
2  
3

- Construction type:**

IM B3 (IM V5, IM V6)  
IM B5 (IM V1, IM V3) available only for shaft height 100 and 132  
IM B35 (IM V15, IM V36)

0  
2  
3

- Holding brake with emergency stop function:<sup>5)</sup>**

Without brake  
Brake connection voltage: **230 V AC, 50 to 60 Hz**  
With brake  
With brake (brake includes microswitch)  
With brake (brake includes manual release)  
With brake (brake includes manual release and microswitch)  
Brake connection voltage: **24 V DC**  
With brake  
With brake (brake includes microswitch)  
With brake (brake includes manual release)  
With brake (brake includes manual release and microswitch)

0  
1  
2  
3  
4  
5  
6  
7  
8

For order number supplements for drive type, direction of air flow, and paint finish (positions 14 through 16 of the order no.), see page 3/35.

# Servo Motors for SIMOVERT MASTERDRIVES

## Asynchronous Servo Motors

1PH7 Motors

### Selection and Ordering Data with SIMOVERT MASTERDRIVES Motion Control<sup>1)</sup>

Power Factor $\cos \varphi$	Magnetizing Current $I_{\mu}$ A	Rated Efficiency $\eta_{rated}$	Rated Frequency $f_{rated}$ Hz	Moment of inertia $J$ kgm <sup>2</sup> (lb <sub>f</sub> -in-s <sup>2</sup> )	Weight, approx. kg (lb)	1PH7 Asynchronous Motors	SIMOVERT MASTERDRIVES MC Inverter/Converter Rated Current			
						Order No.	$I_{rated}$ A	Order No.		
<b>Supply voltage 3-ph. AC 480 V for SIMOVERT MASTERDRIVES Motion Control</b>										
0.88	11.5	0.809	14.3	0.185 (1.6372)	175 (385.9)	1PH7 163 - . . . B . . . . .	34	6SE7 023 - 4 EP50		
0.88	14	0.814	14.3	0.228 (2.0178)	210 (463.1)	1PH7 167 - . . . B . . . . .	37.5	6SE7 023 - 8 D51		
0.81	5.0	0.813	40.6	0.017 (0.1504)	40 (88.2)	1PH7 103 - . . . D . . . . .	10	6SE7 021 - 0 P50		
0.81	8.8	0.838	40.3	0.029 (0.2566)	65 (143.3)	1PH7 107 - . . . D . . . . .	20.5	6SE7 022 - 1 EP50		
0.85	13	0.877	39.7	0.076 (0.6726)	90 (198.5)	1PH7 133 - . . . D . . . . .	34	6SE7 023 - 4 EP50		
0.86	19	0.887	39.6	0.109 (0.9646)	150 (330.8)	1PH7 137 - . . . D . . . . .	47	6SE7 024 - 7 D51		
0.84	25	0.904	39.2	0.185 (1.6372)	175 (385.9)	1PH7 163 - . . . D . . . . .	59	6SE7 026 - 0 D51		
0.83	34	0.909	39.1	0.228 (2.0178)	210 (463.1)	1PH7 167 - . . . D . . . . .	72	6SE7 027 - 2 D51		
0.75	5.7	0.855	60.0	0.017 (0.1504)	40 (88.2)	1PH7 101 - . . . F . . . . .	10	6SE7 021 - 0 P50		
0.84	5.3	0.849	61.0	0.017 (0.1504)	40 (88.2)	1PH7 103 - . . . F . . . . .	14	6SE7 021 - 4 EP50		
0.77	9.3	0.875	60.0	0.029 (0.2566)	65 (143.3)	1PH7 105 - . . . F . . . . .	20.5	6SE7 022 - 1 EP50		
0.80	10.6	0.870	60.3	0.029 (0.2566)	65 (143.3)	1PH7 107 - . . . F . . . . .	27	6SE7 022 - 7 EP50		
<b>• Drive type:</b> Coupling and belt R Coupling and belt S Coupling and belt SR Coupling and belt N						<b>• Vibration sev. grade:</b> R S R R N (only in connection with brake attachment)			<b>• Shaft and flange accuracy:</b> B C D K	
<b>• Direction of air flow:</b> DE → NDE NDE → DE <sup>7)</sup> DE → NDE NDE → DE <sup>7)</sup> DE → NDE NDE → DE <sup>7)</sup>						<b>• Shaft end:</b> With keyway, half-key balancing With keyway, half-key balancing With keyway, full-key balancing With keyway, full-key balancing Without keyway Without keyway			A B C D J K	
<b>• Paint finish:</b> None None, flange and radial shaft sealing ring <sup>6)</sup> Anthracite gray, standard finish (RAL 7016) Anthracite gray, standard finish (RAL 7016), flange and radial shaft sealing ring <sup>6)</sup> Anthracite gray, special finish (RAL 7016) Anthracite gray, special finish (RAL 7016), flange and radial shaft sealing ring <sup>6)</sup>									0 2 3 5 6 8	
<b>• Special models:</b> Please specify additional order code and any required plain text; see Page 3/3.									-Z	
Converter Inverter									E T	

- For rated currents < 37.5 A, Compact PLUS devices are assigned.
- $n_1$ : Maximum permissible speed at constant power or speed where for  $P = P_{rated}$ , there is still a 30% power reserve up to the stall limit.
- $n_{S1}$ : Maximum permissible speed that is continuously permitted without speed duty cycles.
- $n_{max}$ : Maximum rotational speed. This speed may not be exceeded! Notice: Due to  $f_{max.} < 2 \cdot f_{rated}$ , the maximum rotational speed is sometimes limited to smaller values.
- For model with brake: 12th position in ordering no. is "2" or "3"; 14th position is "K"; 15th position is "A", "B", "J" or "K"; 16th position "0", "3" or "6".
- Model prepared for ZF gearbox attachment: 12th data position is "2" or "3"; 13th position is "0"; 14th position is "B", 15th position is "C" or "D"; 16th position is "2", "5" or "8". Stagnant fluids are not permitted at the shaft exit.
- Preferred air flow direction in contaminated environments.

# Servo Motors for SIMOVERT MASTERDRIVES

## Asynchronous Servo Motors

### 1PH7 Motors

#### Selection and Ordering Data with SIMOVERT MASTERDRIVES Motion Control<sup>1)</sup> (continued)

Rated Rotational Speed	Shaft Height	Rated Output	Rated Torque	Rated Current	Rated Voltage	Speed during Field Weakening <sup>2)</sup>	Max. Permissible Continuous Speed <sup>3)</sup>	Max. Speed <sup>4)</sup>	1PH7 Asynchronous Motors
$n_{rated}$		$P_{rated}$	$M_{rated}$	$I_{rated}$	$V_{rated}$	$n_1$	$n_{S1}$	$n_{max}$	Order No.
rpm	SH	kW (HP)	Nm (lb <sub>f</sub> -ft)	A	V	rpm	rpm	rpm	
<b>Supply voltage 3-ph. AC 480 V for SIMOVERT MASTERDRIVES Motion Control</b>									
<b>1750</b>	132	13 (17.43)	71 (52.4)	24	398	3500	3500	3500	<b>1PH7 131</b> – ■ ■ F ■ ■ – ■ ...
		17.5 (23.46)	96 (70.8)	34	398	3500	3500	3500	<b>1PH7 133</b> – ■ ■ F ■ ■ – ■ ...
		21.5 (28.82)	117 (86.3)	42	398	3500	3500	3500	<b>1PH7 135</b> – ■ ■ F ■ ■ – ■ ...
		25 (33.51)	136 (100.3)	56	357	3500	3500	3500	<b>1PH7 137</b> – ■ ■ F ■ ■ – ■ ...
	160	34 (45.58)	186 (137.2)	72	364	3500	3500	3500	<b>1PH7 163</b> – ■ ■ F ■ ■ – ■ ...
		41 (54.96)	224 (165.2)	79	398	3300	3500	3500	<b>1PH7 167</b> – ■ ■ F ■ ■ – ■ ...
<b>2300</b>	100	7.5 (10.05)	31 (22.9)	17	388	4600	4600	4600	<b>1PH7 103</b> – ■ ■ G ■ ■ – ■ ...
		12 (16.08)	50 (442.6)	26	400	4600	4600	4600	<b>1PH7 107</b> – ■ ■ G ■ ■ – ■ ...
	132	22.5 (30.16)	93 (68.6)	45	398	4000	4500	4600	<b>1PH7 133</b> – ■ ■ G ■ ■ – ■ ...
		29 (38.87)	120 (88.5)	56	398	4000	4500	4600	<b>1PH7 137</b> – ■ ■ G ■ ■ – ■ ...
	160	38 (50.94)	158 (116.5)	80	374	3000	3700	4600	<b>1PH7 163</b> – ■ ■ G ■ ■ – ■ ...
		44 (58.98)	183 (135)	85	398	3000	3700	4600	<b>1PH7 167</b> – ■ ■ G ■ ■ – ■ ...

- **Separate fan:**  
 With separate fan  
 Without separate fan, for pipe connection  
 With separate fan, but with metric cable entries in accordance with EN 50262  
 Without separate fan, for pipe connection, but with metric cable entries in accordance with EN 50262

- **Encoder:**  
 Absolute encoder EnDat 2.048 pulses/revolution  
 Incremental encoder sin/cos 1  $V_{pp}$  (without C track or D track)  
 Incremental encoder sin/cos 1  $V_{pp}$  (with C track and D track)  
 Resolver, 2-pole

- **Terminal box arrangement/direction of cable entry (drive-end view):**  
 On top/from right  
 On top/from non-drive end  
 On top/from left

- **Construction type:**  
 IM B3 (IM V5, IM V6)  
 IM B5 (IM V1, IM V3) available only for shaft height 100 and 132  
 IM B35 (IM V15, IM V36)

- **Holding brake with emergency stop function:<sup>5)</sup>**  
 Without brake  
 Brake connection voltage: **230 V AC, 50 to 60 Hz**  
 With brake  
 With brake (brake includes microswitch)  
 With brake (brake includes manual release)  
 With brake (brake includes manual release and microswitch)  
 Brake connection voltage: **24 V DC**  
 With brake  
 With brake (brake includes microswitch)  
 With brake (brake includes manual release)  
 With brake (brake includes manual release and microswitch)

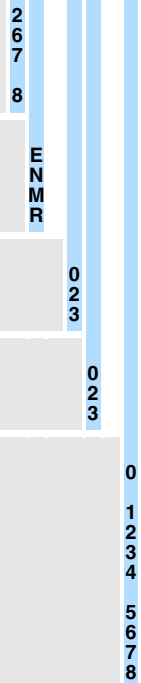

For order number supplements for drive type, direction of air flow, and paint finish (positions 14 through 16 of the order no.), see page 3/37.



# Servo Motors for SIMOVERT MASTERDRIVES

## Asynchronous Servo Motors

1PH7 Motors

### Selection and Ordering Data with SIMOVERT MASTERDRIVES Motion Control<sup>1)</sup> (continued)

Power Factor $\cos \varphi$	Magnetizing Current $I_{\mu}$ A	Rated Efficiency $\eta_{rated}$	Rated Frequency $f_{rated}$ Hz	Moment of inertia $J$ kgm <sup>2</sup> (lb <sub>f</sub> -in-s <sup>2</sup> )	Weight, approx. kg (lb)	1PH7 Asynchronous Motors		SIMOVERT MASTERDRIVES MC Inverter/Converter Rated Current	
						Order No.	$I_{rated}$ A	Order No.	
<b>Supply voltage 3-ph. AC 480 V for SIMOVERT MASTERDRIVES Motion Control</b>									
0.88	8.1	0.902	59.7	0.076 (0.6726)	90 (198.5)	1PH7 131 - . . . F . . . . .	27	6SE7 022 - 7 EP50	
0.85	14	0.900	59.7	0.076 (0.6726)	90 (198.5)	1PH7 133 - . . . F . . . . .	34	6SE7 023 - 4 C51	
0.86	16	0.906	59.5	0.109 (0.9646)	150 (330.8)	1PH7 135 - . . . F . . . . .	47	6SE7 024 - 7 D51	
0.85	23	0.902	59.5	0.109 (0.9646)	150 (330.8)	1PH7 137 - . . . F . . . . .	59	6SE7 026 - 0 D51	
0.86	28	0.915	59.2	0.185 (1.6372)	175 (385.9)	1PH7 163 - . . . F . . . . .	72	6SE7 027 - 2 D51	
0.86	30	0.920	59.2	0.228 (2.0178)	210 (463.1)	1PH7 167 - . . . F . . . . .	92	6SE7 031 - 0 E50	
0.79	8.2	0.866	78.8	0.017 (0.1504)	40 (88.2)	1PH7 103 - . . . G . . . . .	20.5	6SE7 021 - 1 EP50	
0.80	12	0.878	78.7	0.029 (0.2566)	65 (143.3)	1PH7 107 - . . . G . . . . .	27	6SE7 022 - 7 EP50	
0.86	17	0.900	78.0	0.076 (0.6726)	90 (198.5)	1PH7 133 - . . . G . . . . .	47	6SE7 024 - 7 D51	
0.87	21	0.903	77.8	0.109 (0.9646)	150 (330.8)	1PH7 137 - . . . G . . . . .	59	6SE7 026 - 0 D51	
0.83	36	0.900	77.3	0.185 (1.6372)	175 (385.9)	1PH7 163 - . . . G . . . . .	92	6SE7 031 - 0 E50	
0.84	40	0.911	77.4	0.228 (2.0178)	210 (463.1)	1PH7 167 - . . . G . . . . .	92	6SE7 031 - 0 E50	
<b>• Drive type:</b> Coupling and belt R Coupling and belt S Coupling and belt SR Coupling and belt N						<b>• Vibration sev. grade:</b> R R R N (only in connection with brake attachment)		<b>• Shaft and flange accuracy:</b> B C D K	
<b>• Direction of air flow:</b> DE → NDE NDE → DE <sup>7)</sup> DE → NDE NDE → DE <sup>7)</sup> DE → NDE NDE → DE <sup>7)</sup>						<b>• Shaft end:</b> With keyway, half-key balancing With keyway, half-key balancing With keyway, full-key balancing With keyway, full-key balancing Without keyway Without keyway		A B C D J K	
<b>• Paint finish:</b> None None, flange and radial shaft sealing ring <sup>6)</sup> Anthracite gray, standard finish (RAL 7016) Anthracite gray, standard finish (RAL 7016), flange and radial shaft sealing ring <sup>6)</sup> Anthracite gray, special finish (RAL 7016) Anthracite gray, special finish (RAL 7016), flange and radial shaft sealing ring <sup>6)</sup>						0 2 3 5 6 8			
<b>• Special models:</b> Please specify additional order code and any required plain text; see Page 3/3.						-Z			
Converter Inverter								E T	

- For rated currents < 37.5 A, Compact PLUS devices are assigned.
- $n_1$ : Maximum permissible speed at constant power or speed where for  $P = P_{rated}$ , there is still a 30% power reserve up to the stall limit.
- $n_{S1}$ : Maximum permissible speed that is continuously permitted without speed duty cycles.
- $n_{max}$ : Maximum rotational speed. This speed may not be exceeded! Notice: Due to  $f_{max.} < 2 \cdot f_{rated}$ , the maximum rotational speed is sometimes limited to smaller values.
- For model with brake: 12th position in ordering no. is "2" or "3"; 14th position is "K"; 15th position is "A", "B", "J" or "K"; 16th position "0", "3" or "6".
- Model prepared for ZF gearbox attachment: 12th data position is "2" or "3"; 13th position is "0"; 14th position is "B", 15th position is "C" or "D"; 16th position is "2", "5" or "8". Stagnant fluids are not permitted at the shaft exit.
- Preferred air flow direction in contaminated environments.



# Servo Motors for SIMOVERT MASTERDRIVES

## Asynchronous Servo Motors

### 1PH7 Motors

#### Selection and Ordering Data with SIMOVERT MASTERDRIVES Motion Control

Rated Rotational Speed	Shaft Height	Rated Output	Rated Torque	Rated Current	Rated Voltage	Speed during Field Weakening <sup>1)</sup>	Max. Permissible Continuous Speed <sup>2)</sup>	Max. Speed <sup>3)</sup>	1PH7 Asynchronous Motors
$n_{rated}$		$P_{rated}$	$M_{rated}$	$I_{rated}$	$V_{rated}$	$n_1$	$n_{S1}$	$n_{max}$	Order No.
rpm	SH	kW (HP)	Nm (lb <sub>f</sub> -ft)	A	V	rpm	rpm	rpm	
<b>Supply voltage 3-ph. AC 480 V for SIMOVERT MASTERDRIVES Motion Control</b>									
<b>400</b>	180	16.3 (21.85)	390 (287.7)	51	271	800	800	800	<b>1PH7 184</b> – ■ ■ B ■ ■ – ■ ...
		21.2 (28.42)	505 (372.5)	67	268	800	800	800	<b>1PH7 186</b> – ■ ■ B ■ ■ – ■ ...
	225	30.4 (40.75)	725 (534.8)	88	268	800	800	800	<b>1PH7 224</b> – ■ ■ B ■ ■ – ■ ...
		39.2 (52.55)	935 (689.7)	114	264	800	800	800	<b>1PH7 226</b> – ■ ■ B ■ ■ – ■ ...
		48 (64.34)	1145 (844.6)	136	272	800	800	800	<b>1PH7 228</b> – ■ ■ B ■ ■ – ■ ...
<b>1150</b>	180	44 (58.98)	366 (270)	89	383	2300	2300	2300	<b>1PH7 184</b> – ■ ■ D ■ ■ – ■ ...
		58 (77.75)	482 (355.5)	116	390	2300	2300	2300	<b>1PH7 186</b> – ■ ■ D ■ ■ – ■ ...
	225	81 (108.58)	670 (494.2)	160	385	2300	2300	2300	<b>1PH7 224</b> – ■ ■ D ■ ■ – ■ ...
		105 (140.75)	870 (641.7)	197	390	2300	2300	2300	<b>1PH7 226</b> – ■ ■ D ■ ■ – ■ ...
		129 (172.92)	1070 (789.2)	238	390	2300	2300	2300	<b>1PH7 228</b> – ■ ■ D ■ ■ – ■ ...

#### • Separate fan:

- With separate fan
- Without separate fan, for pipe connection
- With separate fan, but with metric cable entries in accordance with EN 50262
- Without separate fan, for pipe connection, but with metric cable entries in accordance with EN 50262

2  
6  
7  
8

#### • Encoder:

- Absolute encoder EnDat 2,048 pulses/revolution
- Incremental encoder sin/cos 1  $V_{pp}$  (without C track or D track)
- Incremental encoder sin/cos 1  $V_{pp}$  (with C track and D track)
- Resolver, 2-pole

E  
N  
M  
R

#### • Terminal box arrangement/direction of cable entry (drive-end view):

- On top/from right
- On top/from drive end
- On top/from non-drive end
- On top/from left

0  
1  
2  
3

#### • Construction type:

- IM B3
  - IM B3
  - IM B35 (only for 1PH7 184 with flange A 400)
  - IM B35 (only for 1PH7 184 with flange A 450)
  - IM B35 (for 1PH7 186 with flange A 450 and 1PH7 22. with flange A 550)
  - IM B35 (only for 1PH7 184 with flange A 400)
  - IM B35 (only for 1PH7 184 with flange A 450)
  - IM B35 (for 1PH7 186 with flange A 450 and 1PH7 22. with flange A 550)
- Hoisting concept for other construction types (IM B6, IM B7, IM B8, IM V5, IM V6)
- Hoisting concept for other construction types (IM V15, IM V36)
- Hoisting concept for other construction types (IM V15, IM V36)
- Hoisting concept for other construction types (IM V15, IM V36)

0  
1  
3  
4  
3  
5  
6  
5

#### • Holding brake with emergency stop function (suitable for IM B3 coupling drive)<sup>4)</sup>:

- Without brake
- With brake (brake includes emergency release screws and microswitch)
- With brake (brake includes manual release and microswitch)

0  
2  
4

For order number supplements for drive type, direction of air flow, and paint finish (positions 14 through 16 of the order no.), see page 3/39.

# Servo Motors for SIMOVERT MASTERDRIVES

## Asynchronous Servo Motors

1PH7 Motors

### Selection and Ordering Data with SIMOVERT MASTERDRIVES Motion Control

Power Factor	Magnetizing Current $I_{\mu}$ A	Rated Efficiency $\eta_{rated}$	Rated Frequency $f_{rated}$ Hz	Moment of inertia $J$ kgm <sup>2</sup> (lb <sub>f</sub> -in-s <sup>2</sup> )	Weight, approx. kg (lb)	1PH7 Asynchronous Motors	SIMOVERT MASTERDRIVES MC	
						Order No.	Inverter/Converter Rated Current $I_{rated}$ A	Order No.
<b>Supply voltage 3-ph. AC 480 V for SIMOVERT MASTERDRIVES Motion Control</b>								
0.84	26	0.830	14.2	0.503 (4.4545)	370 (815.8)	1PH7 184 - . . . B . . . . ■■■■	59	6SE7 026 - 0 ■ D51
0.81	38.5	0.845	14.0	0.666 (5.894)	440 (970.2)	1PH7 186 - . . . B . . . . ■■■■	72	6SE7 027 - 2 ■ D51
0.87	36.5	0.864	14.0	1.479 (13.0889)	630 (1389.2)	1PH7 224 - . . . B . . . . ■■■■	92	6SE7 031 - 0 ■ E50
0.86	49	0.880	14.0	1.930 (17.0802)	750 (1653.8)	1PH7 226 - . . . B . . . . ■■■■	124	6SE7 031 - 2 ■ F50
0.85	60.5	0.888	13.9	2.326 (20.5848)	860 (1896.3)	1PH7 228 - . . . B . . . . ■■■■	155	6SE7 031 - 8 ■ F50
0.83	42	0.920	39.2	0.503 (4.4545)	370 (815.8)	1PH7 184 - . . . D . . . . ■■■■	92	6SE7 031 - 0 ■ E50
0.81	58	0.925	39.1	0.666 (5.894)	440 (970.2)	1PH7 186 - . . . D . . . . ■■■■	124	6SE7 031 - 2 ■ F50
0.81	79	0.938	38.9	1.479 (13.0889)	630 (1389.2)	1PH7 224 - . . . D . . . . ■■■■	175	6SE7 032 - 1 ■ G50
0.84	87.5	0.941	38.9	1.930 (17.0802)	750 (1653.8)	1PH7 226 - . . . D . . . . ■■■■	218	6SE7 032 - 6 ■ G50
0.85	98	0.943	38.9	2.326 (20.5848)	860 (1896.3)	1PH7 228 - . . . D . . . . ■■■■	262	6SE7 033 - 2 ■ G50
<ul style="list-style-type: none"> <li><b>Drive type:</b> <ul style="list-style-type: none"> <li>Coupling R</li> <li>Coupling R</li> <li>Coupling S</li> <li>Coupling SR</li> <li>Belt R</li> <li>Belt R</li> <li>Increased cantilever forces R</li> <li>Increased cantilever forces R</li> </ul> </li> <li><b>Vibration sev. grade:</b> <ul style="list-style-type: none"> <li>R</li> <li>R</li> <li>R</li> <li>R</li> <li>N</li> <li>R</li> <li>N</li> <li>R</li> </ul> </li> <li><b>Shaft and flange accuracy:</b> <ul style="list-style-type: none"> <li>N</li> <li>R</li> <li>R</li> <li>R</li> <li>N</li> <li>R</li> <li>N</li> <li>R</li> </ul> </li> </ul>						A		
<ul style="list-style-type: none"> <li><b>Direction of air flow:</b> <ul style="list-style-type: none"> <li>DE → NDE</li> <li>NDE → DE<sup>6)</sup></li> <li>DE → NDE</li> <li>NDE → DE<sup>6)</sup></li> <li>DE → NDE</li> <li>NDE → DE<sup>6)</sup></li> </ul> </li> <li><b>Shaft end:</b> <ul style="list-style-type: none"> <li>With keyway, half-key balancing</li> <li>With keyway, half-key balancing</li> <li>With keyway, full-key balancing</li> <li>With keyway, full-key balancing</li> <li>Without keyway</li> <li>Without keyway</li> </ul> </li> </ul>						B		
<ul style="list-style-type: none"> <li><b>Paint finish:</b> <ul style="list-style-type: none"> <li>Primed</li> <li>Primed, prepared for ZF gearbox attachment<sup>5)</sup></li> <li>Anthracite gray, standard finish (RAL 7016)</li> <li>Anthracite gray, standard finish (RAL 7016), prepared for ZF gearbox attachment<sup>5)</sup></li> <li>Anthracite gray, special finish (RAL 7016)</li> <li>Anthracite gray, special finish (RAL 7016), prepared for ZF gearbox attachment<sup>5)</sup></li> </ul> </li> </ul>						C		
<ul style="list-style-type: none"> <li><b>Special models:</b> <ul style="list-style-type: none"> <li>Please specify additional order code and any required plain text; see Page 3/3.</li> </ul> </li> </ul>						D		
<ul style="list-style-type: none"> <li>Converter</li> <li>Inverter</li> </ul>						E	T	

- $n_1$ : Maximum permissible speed at constant power or speed where for  $P = P_{rated}$ , there is still a 30% power reserve up to the stall limit.
- $n_{S1}$ : Maximum permissible speed that is continuously permitted without speed duty cycles.
- $n_{max}$ : Maximum rotational speed. This speed may not be exceeded! Notice: Due to  $f_{max} < 2 \cdot f_{rated}$ , the maximum rotational speed is sometimes limited to smaller values.
- For model with brake: 12th data position "0", 14th and 15th position "A", 16th position "0", "3" or "6".
- Model prepared for ZF gearbox attachment: Only for types 1PH7 184, 186, and 224, 12th data position is "3" or "5", 13th is "0"; 14th is "B"; 15th is "C"; 16th is "2", "5" or "8". Stagnant fluids are not permitted at the shaft exit.
- Preferred air flow direction in contaminated environments.

# Servo Motors for SIMOVERT MASTERDRIVES

## Asynchronous Servo Motors

### 1PH7 Motors

#### Selection and Ordering Data with SIMOVERT MASTERDRIVES Motion Control (continued)

Rated Rotational Speed	Shaft Height	Rated Output	Rated Torque	Rated Current	Rated Voltage	Speed during Field Weakening <sup>1)</sup>	Max. Permissible Continuous Speed <sup>2)</sup>	Max. Speed <sup>3)</sup>	1PH7 Asynchronous Motors
$n_{rated}$		$P_{rated}$	$M_{rated}$	$I_{rated}$	$V_{rated}$	$n_1$	$n_{S1}$	$n_{max}$	Order No.
rpm	SH	kW (HP)	Nm (lb <sub>f</sub> -ft)	A	V	rpm	rpm	rpm	
<b>Supply voltage 3-ph. AC 480 V for SIMOVERT MASTERDRIVES Motion Control</b>									
<b>1750</b>	180	60 (80.43)	327 (241.2)	120	388	3500	3500 <sup>4)</sup>	3500	<b>1PH7 184</b> – ■ ■ F ■ ■ – ■ ...
		85 (113.94)	465 (343)	169	385	3500	3500 <sup>4)</sup>	3500	<b>1PH7 186</b> – ■ ■ F ■ ■ – ■ ...
	225	110 (147.45)	600 (442.6)	203	395	2900	3100 <sup>4)</sup>	3500	<b>1PH7 224</b> – ■ ■ U ■ ■ – ■ ...
		135 (180.97)	737 (543.6)	254	395	2900	3100 <sup>4)</sup>	3500	<b>1PH7 226</b> – ■ ■ F ■ ■ – ■ ...
		179 (239.95)	975 (719.2)	342	395	2900	3100 <sup>4)</sup>	3500	<b>1PH7 228</b> – ■ ■ F ■ ■ – ■ ...
<b>2900</b>	180	81 (108.58)	265 (195.5)	158	395	5000	3500 <sup>4)</sup>	5000	<b>1PH7 184</b> – ■ ■ L ■ ■ – ■ ...
		101 (135.39)	333 (245.6)	206	385	5000	3500 <sup>4)</sup>	5000	<b>1PH7 186</b> – ■ ■ L ■ ■ – ■ ...
	225	149 (199.73)	490 (543.6)	274	395	3500	3100 <sup>4)</sup>	4500	<b>1PH7 224</b> – ■ ■ L ■ ■ – ■ ...
		185 (247.99)	610 (449.9)	348	390	3500	3100 <sup>4)</sup>	4500	<b>1PH7 226</b> – ■ ■ L ■ ■ – ■ ...
		215 (288.2)	708 (522.2)	402	395	3500	3100 <sup>4)</sup>	4500 <sup>4)</sup>	<b>1PH7 228</b> – ■ ■ L ■ ■ – ■ ...

**• Separate fan:**

- With separate fan
- Without separate fan, for pipe connection
- With separate fan, but with metric cable entries in accordance with EN 50262
- Without separate fan, for pipe connection, but with metric cable entries in accordance with EN 50262

2  
6  
7  
8

**• Encoder:**

- Absolute encoder EnDat 2,048 pulses/revolution
- Incremental encoder sin/cos 1 V<sub>pp</sub> (without C track or D track)
- Incremental encoder sin/cos 1 V<sub>pp</sub> (with C track and D track)
- Resolver, 2-pole

E  
N  
M  
R

**• Terminal box arrangement/direction of cable entry (drive-end view):**

- On top/from right
- On top/from drive end
- On top/from non-drive end
- On top/from left

0  
1  
2  
3

**• Construction type:**

- IM B3
  - IM B3
  - IM B35 (only for 1PH7 184 with flange A 400)
  - IM B35 (only for 1PH7 184 with flange A 450)
  - IM B35 (for 1PH7 186 with flange A 450 and 1PH7 22. with flange A 550)
  - IM B35 (only for 1PH7 184 with flange A 400)
  - IM B35 (only for 1PH7 184 with flange A 450)
  - IM B35 (for 1PH7 186 with flange A 450 and 1PH7 22. with flange A 550)
- Hoisting concept for other construction types (IM B6, IM B7, IM B8, IM V5, IM V6)
- Hoisting concept for other construction types (IM V15, IM V36)
- Hoisting concept for other construction types (IM V15, IM V36)
- Hoisting concept for other construction types (IM V15, IM V36)

0  
1  
3  
4  
3  
5  
6  
5

**• Holding brake with emergency stop function (suitable for IM B3 coupling drive)<sup>5)</sup>:**

- Without brake
- With brake (brake includes emergency release screws and microswitch)
- With brake (brake includes manual release and microswitch)

0  
2  
4

For order number supplements for drive type, direction of air flow, and paint finish (positions 14 through 16 of the order no.), see page 3/41.

# Servo Motors for SIMOVERT MASTERDRIVES

## Asynchronous Servo Motors

1PH7 Motors

### Selection and Ordering Data with SIMOVERT MASTERDRIVES Motion Control (continued)

Power Factor	Magnetizing Current $I_{\mu}$ A	Rated Efficiency $\eta_{rated}$	Rated Frequency $f_{rated}$ Hz	Moment of inertia $J$ kgm <sup>2</sup> (lb <sub>f</sub> -in-s <sup>2</sup> )	Weight, approx. kg (lb)	1PH7 Asynchronous Motors	SIMOVERT MASTERDRIVES MC Inverter/Converter Rated Current			
						Order No.	$I_{rated}$ A	Order No.		
<b>Supply voltage 3-ph. AC 480 V for SIMOVERT MASTERDRIVES Motion Control</b>										
0.78	64	0.934	59.0	0.503 (4.4545)	370 (815.8)	1PH7 184 - . . . F . . . . ■ ■ ■ ■	124	6SE7 031 - 2 ■ F50		
0.80	84	0.940	59.0	0.666 (5.894)	440 (970.2)	1PH7 186 - . . . F . . . . ■ ■ ■ ■	186	6SE7 032 - 1 ■ G50		
0.84	88	0.944	58.9	1.479 (13.0889)	630 (1389.2)	1PH7 224 - . . . U . . . . ■ ■ ■ ■	210	6SE7 032 - 6 ■ G50		
0.82	120	0.947	58.9	1.930 (17.0802)	750 (1653.8)	1PH7 226 - . . . F . . . . ■ ■ ■ ■	262	6SE7 033 - 2 ■ G50		
0.81	169	0.948	58.8	2.326 (20.5848)	860 (1896.3)	1PH7 228 - . . . F . . . . ■ ■ ■ ■	423	6SE7 035 - 1 E K50		
0.80	77	0.934	97.4	0.503 (4.4545)	370 (815.8)	1PH7 184 - . . . L . . . . ■ ■ ■ ■	175	6SE7 032 - 1 ■ G50		
0.78	107	0.936	97.3	0.666 (5.894)	440 (970.2)	1PH7 186 - . . . L . . . . ■ ■ ■ ■	218	6SE7 032 - 6 ■ G50		
0.84	115	0.946	97.3	1.479 (13.0889)	630 (1389.2)	1PH7 224 - . . . L . . . . ■ ■ ■ ■	308	6SE7 033 - 7 ■ G50		
0.83	154	0.947	97.2	1.930 (17.0802)	750 (1653.8)	1PH7 226 - . . . L . . . . ■ ■ ■ ■	423	6SE7 035 - 1 E K50		
0.82	186	0.946	97.2	2.326 (20.5848)	860 (1896.3)	1PH7 228 - . . . L . . . . ■ ■ ■ ■	491	6SE7 036 - 0 E K50		
<b>• Drive type:</b> Coupling R Coupling R Coupling S Coupling SR Belt R Belt R Increased cantilever forces R Increased cantilever forces R						<b>• Vibration sev. grade:</b> R R R R N R N R			<b>• Shaft and flange accuracy:</b> N R R R R R N R	
<b>• Direction of air flow:</b> DE → NDE NDE → DE <sup>7)</sup> DE → NDE NDE → DE <sup>7)</sup> DE → NDE NDE → DE <sup>7)</sup>						<b>• Shaft end:</b> With keyway, half-key balancing With keyway, half-key balancing With keyway, full-key balancing With keyway, full-key balancing Without keyway Without keyway			A B C D E F G H  A B C D J K  0 2 3 5 6 8  -Z	
<b>• Paint finish:</b> Primed Primed, prepared for ZF gearbox attachment <sup>6)</sup> Anthracite gray, standard finish (RAL 7016) Anthracite gray, standard finish (RAL 7016), prepared for ZF gearbox attachment <sup>6)</sup> Anthracite gray, special finish (RAL 7016) Anthracite gray, special finish (RAL 7016), prepared for ZF gearbox attachment <sup>6)</sup>										
<b>• Special models:</b> Please specify additional order code and any required plain text; see Page 3/3.										
Converter Inverter									E T	

- $n_1$ : Maximum permissible speed at constant power or speed where for  $P = P_{rated}$ , there is still a 30% power reserve up to the stall limit.
- $n_{S1}$ : Maximum permissible speed that is continuously permitted without speed duty cycles.
- $n_{max}$ : Maximum rotational speed. This speed may not be exceeded! Notice: Due to  $f_{max} < 2 \cdot f_{rated}$ , the maximum rotational speed is sometimes limited to smaller values.
- Rotational speed is reduced in the event of increased cantilever forces, see Part 7.
- For model with brake: 12th data position "0", 14th and 15th position "A", 16th position "0", "3" or "6".
- Model prepared for ZF gearbox attachment: Only for types 1PH7 184, 186, and 224, 12th data position is "3" or "5", 13th is "0"; 14th is "B"; 15th is "C"; 16th is "2", "5" or "8". Stagnant fluids are not permitted at the shaft exit.
- Preferred air flow direction in contaminated environments.

# Servo Motors for SIMOVERT MASTERDRIVES

## Asynchronous Servo Motors

### 1PH7 Motors, Shaft Height 280

#### Selection and Ordering Data

##### Permissible Combinations of Mechanical Models

**1PH7 28 . Motors**  
**Shaft Height 280**

Position in  
Order No. 8 9 10 11 12 13 14 15 16  
**1PH7 28 . -** ■ . . . ■ ■ ■ . . . ■ . . .

##### Permissible Combinations of Mechanical Models

**Separately driven fan**  
8th Position in Order No.  
**1PH7 28 . -** ■ . . . . .

##### Order No. Supplement

0	1	2	3	4	5	6
NDE <b>Top</b> Non- Drive End --> Drive End	NDE <b>Right</b> Non- Drive End --> Drive End	NDE <b>Left</b> Non- Drive End --> Drive End	Drive End <b>Top</b> Drive End --> Non- Drive End	Drive End <b>Right</b> Drive End --> Non- Drive End	Drive End <b>Left</b> Drive End --> Non- Drive End	<b>Simple Pipe Connection Non-Drive End Right</b> (Can Be Converted to Non- Drive End Left)

**1PH7 28 . - . . . . 0 - . . . .** Type of construction IM B3

**1PH7 28 . - . . . . 1 - . . . .** Type IM V5  
(Can be converted later to  
IM V6)

**1PH7 28 . - . . . . 3 - . . . .** Type of construction IM B35

**1PH7 28 . - . . . . 5 - . . . .** Type IM V15  
(Can be converted later to  
IM V36)

##### Option order codes

- R1Y** Standard finish RAL ...
- R2Y** Special finish RAL ...
- G14** With air filter
- K08** Encoder connector attachment, facing
- K55** Customer-specific entry plate for terminal box<sup>1)</sup>
- K83** Terminal box rotation by + 90 degrees (from standard position)
- K84** Terminal box rotation by - 90 degrees (from standard position)
- K85** Terminal box rotation by 180 degrees (from standard position)
- K16** Additional normal shaft end (only available with no encoder)
- K31** Additional rating plate
- K45** 230 V standstill heating
- C30** 690 V model
- Y55** Atypical shaft end, drive side
- Y80** Different rating plate data<sup>1)</sup>
- Y82** Additional plate with customer information<sup>1)</sup>
- M83** Additional pulling thread on motor feet

Standard Model
Approved Supplemental Types

1) Plain text required





# Servo Motors for SIMOVERT MASTERDRIVES

## Asynchronous Servo Motors

### 1PL6 Motors

#### Overview



1PL6 AC Motors, Shaft Height 180 to 225



1PL6 AC Motors, Shaft Height 280

The AC motors in the 1PL6 series are compact, forced ventilated asynchronous motors with a squirrel cage rotor with IP23 degree of protection. A built-on external ventilation unit is the standard means of ventilation for these motors.

1PH7 motors can be ordered with an air flow from the motor shaft (drive end) toward the back of the motor (non-drive end) or an air flow in the opposite direction.

These motors were developed especially for operation on the SIMOVERT MASTERDRIVES Vector Control and Motion Control drive system. Depending on the control requirements, appropriate encoder systems for measuring motor speed and indirect positions are available for these motors.

These motors comply with DIN standards and have IP23 degree of protection in accordance with EN 60034-5 (and IEC 60034-5). With this degree of protection, these motors are not suited for operation in corrosive atmospheres or outdoor installation.

#### Uses/Benefits

- Extremely high power density with a very low unit volume (50 to 60% higher output compared to 1PH7 with IP55 degree of protection)
- Speed to zero without torque reduction
- Robustness
- Very little maintenance required
- High transverse load capability
- High rotational accuracy even at very low speeds
- Integrated encoder system for measuring motor speed, connected via connectors
- Terminal boxes for connecting power cables
- KTY 84 monitoring of motor temperature
- Variable ventilation systems
- Simple external ventilation through pipe connection
- Bearing with relubrication unit and insulated bearing (non-drive end) options

#### Application

For use in dry, indoor installations (not in corrosive atmospheres)

Hoisting equipment:

- Hoisting and grab-closing gear for cranes

Printing industry:

- Main drives for printing machines

Manufacture of rubber, plastics, and wire:

- Drives for extruders, calanders, rubber-injection plants, plastic film machines, and tile-making plants
- Wire-drawing machines, wire-stranding machines, etc.

General applications such as coiler and winder drives.

# Servo Motors for SIMOVERT MASTERDRIVES

## Asynchronous Servo Motors

1PL6 Motors

### Technical Data

Insulation of the stator winding in accordance with EN 60034-1 (IEC 60034-1)	Temperature class F for a coolant temperature up to +40 °C (+104 °F)
Fan connection adjustment (See Technical Data, Part 7)	400 V 3-phase AC/50 Hz/60 Hz 480 V 3-phase AC/60 Hz
Construction type in accordance with EN 60034-7 (IEC 60034-7)	IM B3
Degrees of protection in acc. with EN 60034-5 (IEC 60034-5)	IP23
Cooling in accordance with EN 60034-6 (IEC 60034-6)	Forced ventilation and open-circuit cooling SH 180 and 225: Fan built onto axial NDE SH 280: Fan built onto radial NDE
Temperature monitoring	KTY 84 temperature sensor in the stator winding SH 280: Additional KTY 84 as spare
Paint finish	Primed, standard paint finish, anthracite gray RAL 7016
Shaft end on the DE in acc. with DIN 748-3 (IEC 60072-1)	With keyway, half-key balancing
Shaft and flange accuracy in accordance with DIN 42955 (IEC 60072-1)	Tolerance N (normal)
Vibration severity grade in accordance with EN 60034-14 (IEC 60034-14)	SH 180 and 225: Grade R (reduced) SH 280: Grade N (normal)
Sound pressure level according to EN 1680 Tolerance +3 dB	Sound pressure level depends on direction of ventilation See Part 7
Bearing designs and maximum speeds	See Part 7
Encoder system, integrated	– Incremental encoder HTL 1,024 pulses/revolution – Incremental encoder sin/cos 1 V <sub>pp</sub> , 2,048 pulses/revolution – Absolute encoder EnDat 2,048 pulses/revolution – Resolver, 2-pole
Connection	Connectors for signals (mating connector not included) Terminal box for power SH 180 and 225: Terminal box on top SH 280: Terminal box non-drive end, on right
Options	See Selection and Ordering Data and Options table on this page

### Options

Code	Description	In 1PL6 Asynchronous Servo Motor Type	
		SH 180	SH 280
R1Y	Standard paint finish in another color RAL ... (plain text required)	■	■
R2Y	Special paint finish in another color RAL ... (plain text required)	■	■
C30	690 V winding	–	■
G14	Fan group with air filter	●	■
G80	POG 10 pulse encoder, prepared attachment	–	■
K08	Encoder connector attachment, facing	–	■
K16	Additional normal shaft end (only available without encoder)	–	■
K31	2nd rating plate comes unattached in terminal box	■	■
K40	Relubrication, drive end and non-drive end	■	Standard
K45	230 V standstill heating	–	■
K55	Customer-specific entry plate for terminal box (plain text required)	■	■
K83	Terminal box rotation by + 90 degrees (from standard position)	–	■
K84	Terminal box rotation by - 90 degrees (from standard position)	–	■
K85	Terminal box rotation by +180 degrees (from standard position)	–	■
L27	Insulated non-drive end bearing	■	Standard
M83	Additional pulling thread on motor feet	–	■
Y55	Atypical shaft end, drive side	●	●
Y80	Different rating plate data (plain text required)	●	●
Y82	Additional plate with customer information	●	●

■ Option available  
 ● On request  
 – Not available

3

### Characteristics

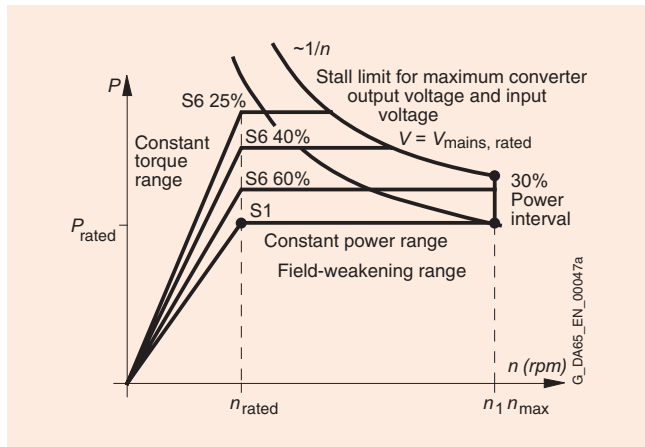

Power-Speed Curve



# Servo Motors for SIMOVERT MASTERDRIVES

## Asynchronous Servo Motors

### 1PL6 Motors

#### Selection and Ordering Data with SIMOVERT MASTERDRIVES Vector Control

Rated Rotational Speed	Shaft Height	Rated Output	Rated Torque	Rated Current	Rated Voltage	Speed during Field Weakening <sup>1)</sup>	Max. Permissible Continuous Speed <sup>2)</sup>	Max. Speed <sup>3)</sup>	1PL6 Asynchronous Motors
$n_{rated}$		$P_{rated}$	$M_{rated}$	$I_{rated}$	$V_{rated}$	$n_1$	$n_{S1}$	$n_{max}$	Order No.
rpm	SH	kW (HP)	Nm (lb <sub>f</sub> -ft)	A	V	rpm	rpm	rpm	
<b>Supply voltage 3-ph. AC 400 V for SIMOVERT MASTERDRIVES Vector Control</b>									
<b>400</b>	180	24.5 (32.84)	585 (431.5)	69	300	1000	2000	2000	<b>1PL6 184 - ■ ■ B ■ ■ - 0 . . .</b>
		31.5 (42.23)	752 (554.7)	90	290	1400	2000	2000	<b>1PL6 186 - ■ ■ B ■ ■ - 0 . . .</b>
	225	45 (60.32)	1074 (792.2)	117	300	1150	2000	2000	<b>1PL6 224 - ■ ■ B ■ ■ - 0 . . .</b>
		57 (76.41)	1361 (1003.9)	145	305	1400	2000	2000	<b>1PL6 226 - ■ ■ B ■ ■ - 0 . . .</b>
		72 (96.51)	1719 (1267.9)	181	305	1300	2000	2000	<b>1PL6 228 - ■ ■ B ■ ■ - 0 . . .</b>
<b>1150</b>	180	65 (87.13)	540 (398.3)	121	400	1750	3500 <sup>4)</sup>	5000	<b>1PL6 184 - ■ ■ D ■ ■ - 0 . . .</b>
		85 (113.94)	706 (520.7)	158	400	1950	3500 <sup>4)</sup>	5000	<b>1PL6 186 - ■ ■ D ■ ■ - 0 . . .</b>
	225	120 (160.86)	997 (735.4)	218	400	2100	3100 <sup>4)</sup>	4500	<b>1PL6 224 - ■ ■ D ■ ■ - 0 . . .</b>
		155 (207.77)	1287 (949.3)	275	400	2000	3100 <sup>4)</sup>	4500	<b>1PL6 226 - ■ ■ D ■ ■ - 0 . . .</b>
		190 (254.69)	1578 (1161.7)	334	400	1850	3100 <sup>4)</sup>	4500 <sup>4)</sup>	<b>1PL6 228 - ■ ■ D ■ ■ - 0 . . .</b>

**Separate fan:**

- With separate fan
- Without separate fan, for pipe connection
- With separate fan, but with metric cable entries in accordance with EN 50262
- Without separate fan, for pipe connection, but with metric cable entries in accordance with EN 50262

4  
6  
7  
8

**Encoder:**

- Without encoder
- Incremental encoder HTL (1,024 pulses/revolution)
- Incremental encoder HTL (2,048 pulses/revolution)

A  
H  
J

**Terminal box arrangement/direction of cable entry (drive-end view):**

- On top/from right
- On top/from drive end
- On top/from non-drive end
- On top/from left

0  
1  
2  
3

**Construction type:**

- IM B3
  - IM B3
  - IM B35 (SH 180: With flange A 450, SH 225: With flange A 550)
  - IM B35 (SH 180: With flange A 450, SH 225: With flange A 550)
- Hoisting concept for other construction types (IM B6, IM B7, IM B8, IM V5, IM V6)
- Hoisting concept for other construction types (IM V15, IM V36)

0  
1  
3  
5

For order number supplements for drive type, direction of air flow, and paint finish (positions 14 through 16 of the order no.), see page 3/47.

# Servo Motors for SIMOVERT MASTERDRIVES

## Asynchronous Servo Motors

1PL6 Motors

3

### Selection and Ordering Data with SIMOVERT MASTERDRIVES Vector Control

Power Factor	Magnetizing Current $I_{\mu}$ A	Rated Efficiency $\eta_{rated}$	Rated Frequency $f_{rated}$ Hz	Moment of inertia $J$ kgm <sup>2</sup> (lb <sub>f</sub> -in-s <sup>2</sup> )	Weight, approx. kg (lb)	1PL6 Asynchronous Motors		SIMOVERT MASTERDRIVES VC Inverter/Converter Rated Current	
						Order No.	$I_{rated}$ A	Order No.	
<b>Supply voltage 3-ph. AC 400 V for SIMOVERT MASTERDRIVES Vector Control</b>									
0.86	33	0.80	14.4	0.503 (4.4545)	370 (815.8)	1PL6 184 - . . B . . - 0 ■■■■	72	6SE7 027 - 2 ■ D61	
0.85	47	0.814	14.3	0.666 (5.894)	440 (970.2)	1PL6 186 - . . B . . - 0 ■■■■	92	6SE7 031 - 0 ■ E60	
0.87	45	0.844	14.2	1.479 (13.0889)	630 (1389.2)	1PL6 224 - . . B . . - 0 ■■■■	124	6SE7 031 - 2 ■ F60	
0.85	67	0.868	14.0	1.930 (17.0802)	750 (1653.8)	1PL6 226 - . . B . . - 0 ■■■■	146	6SE7 031 - 5 ■ F60	
0.86	77	0.871	14.0	2.326 (20.5848)	860 (1896.3)	1PL6 228 - . . B . . - 0 ■■■■	186	6SE7 031 - 8 ■ F60	
0.86	46	0.906	39.4	0.503 (4.4545)	370 (815.8)	1PL6 184 - . . D . . - 0 ■■■■	124	6SE7 031 - 2 ■ F60	
0.86	62	0.910	39.4	0.666 (5.894)	440 (970.2)	1PL6 186 - . . D . . - 0 ■■■■	186	6SE7 031 - 8 ■ F60	
0.85	86	0.930	39.1	1.479 (13.0889)	630 (1389.2)	1PL6 224 - . . D . . - 0 ■■■■	260	6SE7 032 - 6 ■ G60	
0.87	92	0.930	39.2	1.930 (17.0802)	750 (1653.8)	1PL6 226 - . . D . . - 0 ■■■■	315	6SE7 033 - 2 ■ G60	
0.88	102	0.931	39.2	2.326 (20.5848)	860 (1896.3)	1PL6 228 - . . D . . - 0 ■■■■	370	6SE7 033 - 7 ■ G60	
<ul style="list-style-type: none"> <li><b>Drive type:</b> <ul style="list-style-type: none"> <li>Coupling R</li> <li>Coupling R</li> <li>Coupling S</li> <li>Coupling SR</li> <li>Belt R</li> <li>Belt R</li> <li>Increased cantilever forces R</li> <li>Increased cantilever forces R</li> </ul> </li> <li><b>Vibration sev. grade:</b> <ul style="list-style-type: none"> <li>R</li> <li>R</li> <li>R</li> <li>R</li> <li>N</li> <li>R</li> <li>N</li> <li>R</li> </ul> </li> <li><b>Shaft and flange accuracy:</b> <ul style="list-style-type: none"> <li>N</li> <li>R</li> <li>R</li> <li>R</li> <li>N</li> <li>R</li> <li>N</li> <li>R</li> </ul> </li> </ul>						A B C D E F G H			
<ul style="list-style-type: none"> <li><b>Direction of air flow:</b> <ul style="list-style-type: none"> <li>DE → NDE</li> <li>NDE → DE<sup>5)</sup></li> <li>DE → NDE</li> <li>NDE → DE<sup>5)</sup></li> <li>DE → NDE</li> <li>NDE → DE<sup>5)</sup></li> </ul> </li> <li><b>Shaft end:</b> <ul style="list-style-type: none"> <li>With keyway, half-key balancing</li> <li>With keyway, half-key balancing</li> <li>With keyway, full-key balancing</li> <li>With keyway, full-key balancing</li> <li>Without keyway</li> <li>Without keyway</li> </ul> </li> </ul>						A B C D J K			
<ul style="list-style-type: none"> <li><b>Paint finish:</b> <ul style="list-style-type: none"> <li>Primed</li> <li>Anthracite gray, standard finish (RAL 7016)</li> <li>Anthracite gray, special finish (RAL 7016)</li> </ul> </li> </ul>						0 3 6			
<ul style="list-style-type: none"> <li><b>Special models:</b> <ul style="list-style-type: none"> <li>Please specify additional order code and any required plain text; see Page 3/45.</li> </ul> </li> </ul>						-Z			
<ul style="list-style-type: none"> <li>Converter</li> <li>Inverter</li> </ul>								E T	

- $n_1$ : Maximum permissible speed at constant power or speed where for  $P = P_{rated}$ , there is still a 30% power reserve up to the stall limit.
- $n_{S1}$ : Maximum permissible speed that is continuously permitted without speed duty cycles.
- $n_{max}$ : Maximum rotational speed. This speed may not be exceeded! Notice: Due to  $f_{max} < 5 \cdot f_{rated}$ , the maximum rotational speed is sometimes limited to smaller values.
- Rotational speed is reduced in the event of increased cantilever forces, see Part 7.
- Preferred air flow direction in contaminated environments.

# Servo Motors for SIMOVERT MASTERDRIVES

## Asynchronous Servo Motors

### 1PL6 Motors

#### Selection and Ordering Data with SIMOVERT MASTERDRIVES Vector Control (continued)

Rated Rotational Speed	Shaft Height	Rated Output	Rated Torque	Rated Current	Rated Voltage	Speed during Field Weakening <sup>1)</sup>	Max. Permissible Continuous Speed <sup>2)</sup>	Max. Speed <sup>3)</sup>	1PL6 Asynchronous Motors
$n_{rated}$		$P_{rated}$	$M_{rated}$	$I_{rated}$	$V_{rated}$	$n_1$	$n_{S1}$	$n_{max}$	Order No.
rpm	SH	kW (HP)	Nm (lb <sub>f</sub> -ft)	A	V	rpm	rpm	rpm	
<b>Supply voltage 3-ph. AC 400 V for SIMOVERT MASTERDRIVES Vector Control</b>									
<b>1750</b>	180	89 (119.3)	486 (358.5)	166	400	3500	3500 <sup>4)</sup>	5000	<b>1PL6 184 - ■ ■ F ■ ■ - 0 . . .</b>
		125 (167.56)	682 (503)	231	400	3400	3500 <sup>4)</sup>	5000	<b>1PL6 186 - ■ ■ F ■ ■ - 0 . . .</b>
	225	165 (221.18)	900 (663.8)	292	400	3000	3100 <sup>4)</sup>	4500	<b>1PL6 224 - ■ ■ F ■ ■ - 0 . . .</b>
		200 (268.1)	1091 (804.7)	350	400	2900	3100 <sup>4)</sup>	4500	<b>1PL6 226 - ■ ■ F ■ ■ - 0 . . .</b>
		265 (355.23)	1446 (1066.6)	470	400	2900	3100 <sup>4)</sup>	4500 <sup>4)</sup>	<b>1PL6 228 - ■ ■ F ■ ■ - 0 . . .</b>
<b>2900</b>	180	113 (151.47)	372 (274.4)	209	400	5000	3500 <sup>4)</sup>	5000	<b>1PL6 184 - ■ ■ L ■ ■ - 0 . . .</b>
		150 (201.07)	494 (364.4)	280	390	5000	3500 <sup>4)</sup>	5000	<b>1PL6 186 - ■ ■ L ■ ■ - 0 . . .</b>
	225	205 (274.8)	675 (479.9)	365	400	3500	3100 <sup>4)</sup>	4500	<b>1PL6 224 - ■ ■ L ■ ■ - 0 . . .</b>
		270 (361.93)	889 (655.7)	470	400	3500	3100 <sup>4)</sup>	4500	<b>1PL6 226 - ■ ■ L ■ ■ - 0 . . .</b>
		300 (402.14)	988 (728.7)	530	400	3500	3100 <sup>4)</sup>	4500 <sup>4)</sup>	<b>1PL6 228 - ■ ■ L ■ ■ - 0 . . .</b>

**• Separate fan:**

- With separate fan
- Without separate fan, for pipe connection
- With separate fan, but with metric cable entries in accordance with EN 50262
- Without separate fan, for pipe connection, but with metric cable entries in accordance with EN 50262

4  
6  
7  
8

**• Encoder:**

- Without encoder
- Incremental encoder HTL (1,024 pulses/revolution)
- Incremental encoder HTL (2,048 pulses/revolution)

A  
H  
J

**• Terminal box arrangement/direction of cable entry (drive-end view):**

- On top/from right
- On top/from drive end
- On top/from non-drive end
- On top/from left

0  
1  
2  
3

**• Construction type:**

- IM B3
  - IM B3
  - IM B35 (SH 180: With flange A 450, SH 225: With flange A 550)
  - IM B35 (SH 180: With flange A 450, SH 225: With flange A 550)
- Hoisting concept for other construction types (IM B6, IM B7, IM B8, IM V5, IM V6)
- Hoisting concept for other construction types (IM V15, IM V36)

0  
1  
3  
5

For order number supplements for drive type, direction of air flow, and paint finish (positions 14 through 16 of the order no.), see page 3/49.

# Servo Motors for SIMOVERT MASTERDRIVES

## Asynchronous Servo Motors

1PL6 Motors

### Selection and Ordering Data with SIMOVERT MASTERDRIVES Vector Control (continued)

Power Factor	Magnetizing Current $I_{\mu}$ A	Rated Efficiency $\eta_{rated}$	Rated Frequency $f_{rated}$ Hz	Moment of inertia $J$ kgm <sup>2</sup> (lb <sub>f</sub> -in-s <sup>2</sup> )	Weight, approx. kg (lb)	1PL6 Asynchronous Motors	SIMOVERT MASTERDRIVES VC Inverter/Converter Rated Current	
						Order No.	$I_{rated}$ A	Order No.
<b>Supply voltage 3-ph. AC 400 V for SIMOVERT MASTERDRIVES Vector Control</b>								
0.84	68	0.921	59.3	0.503 (4.4545)	370 (815.8)	1PL6 184 - . . F . . - 0 ■■■	186	6SE7 031 - 8 ■ F60
0.84	92	0.935	59.3	0.666 (5.894)	440 (970.2)	1PL6 186 - . . F . . - 0 ■■■	260	6SE7 032 - 6 ■ G60
0.87	90	0.942	59.2	1.479 (13.0889)	630 (1389.2)	1PL6 224 - . . F . . - 0 ■■■	315	6SE7 033 - 2 ■ G60
0.87	122	0.942	59.1	1.930 (17.0802)	750 (1653.8)	1PL6 226 - . . F . . - 0 ■■■	370	6SE7 033 - 7 ■ G60
0.86	174	0.948	59.0	2.326 (20.5848)	860 (1896.3)	1PL6 228 - . . F . . - 0 ■■■	510	6SE7 035 - 1 ■ K/J60
0.85	79	0.938	97.6	0.503 (4.4545)	370 (815.8)	1PL6 184 - . . L . . - 0 ■■■	210	6SE7 032 - 1 ■ G60
0.84	110	0.943	97.5	0.666 (5.894)	440 (970.2)	1PL6 186 - . . L . . - 0 ■■■	315	6SE7 033 - 2 ■ G60
0.86	118	0.950	97.5	1.479 (13.0889)	630 (1389.2)	1PL6 224 - . . L . . - 0 ■■■	370	6SE7 033 - 7 ■ G60
0.87	160	0.952	97.4	1.930 (17.0802)	750 (1653.8)	1PL6 226 - . . L . . - 0 ■■■	510	6SE7 035 - 1 ■ K/J60
0.86	188	0.952	97.3	2.326 (20.5848)	860 (1896.3)	1PL6 228 - . . L . . - 0 ■■■	590	6SE7 036 - 0 ■ K/J60
<ul style="list-style-type: none"> <li><b>Drive type:</b> <ul style="list-style-type: none"> <li>Coupling R</li> <li>Coupling R</li> <li>Coupling S</li> <li>Coupling SR</li> <li>Belt R</li> <li>Belt R</li> <li>Increased cantilever forces R</li> <li>Increased cantilever forces R</li> </ul> </li> <li><b>Vibration sev. grade:</b> <ul style="list-style-type: none"> <li>R</li> <li>R</li> <li>R</li> <li>R</li> <li>N</li> <li>R</li> <li>N</li> <li>R</li> </ul> </li> <li><b>Shaft and flange accuracy:</b> <ul style="list-style-type: none"> <li>N</li> <li>R</li> <li>R</li> <li>R</li> <li>N</li> <li>R</li> <li>N</li> <li>R</li> </ul> </li> </ul>						A		
<ul style="list-style-type: none"> <li><b>Direction of air flow:</b> <ul style="list-style-type: none"> <li>DE → NDE</li> <li>NDE → DE<sup>5)</sup></li> <li>DE → NDE</li> <li>NDE → DE<sup>5)</sup></li> <li>DE → NDE</li> <li>NDE → DE<sup>5)</sup></li> </ul> </li> <li><b>Shaft end:</b> <ul style="list-style-type: none"> <li>With keyway, half-key balancing</li> <li>With keyway, half-key balancing</li> <li>With keyway, full-key balancing</li> <li>With keyway, full-key balancing</li> <li>Without keyway</li> <li>Without keyway</li> </ul> </li> </ul>						B		
<ul style="list-style-type: none"> <li><b>Paint finish:</b> <ul style="list-style-type: none"> <li>Primed</li> <li>Anthracite gray, standard finish (RAL 7016)</li> <li>Anthracite gray, special finish (RAL 7016)</li> </ul> </li> </ul>						C		
<ul style="list-style-type: none"> <li><b>Special models:</b> <ul style="list-style-type: none"> <li>Please specify additional order code and any required plain text; see Page 3/45.</li> </ul> </li> </ul>						D		
<ul style="list-style-type: none"> <li>Converter</li> <li>Inverter</li> </ul>						E	T	

- $n_1$ : Maximum permissible speed at constant power or speed where for  $P = P_{rated}$ , there is still a 30% power reserve up to the stall limit.
- $n_{S1}$ : Maximum permissible speed that is continuously permitted without speed duty cycles.
- $n_{max}$ : Maximum rotational speed. This speed may not be exceeded! Notice: Due to  $f_{max} < 5 \cdot f_{rated}$ , the maximum rotational speed is sometimes limited to smaller values.
- Rotational speed is reduced in the event of increased cantilever forces, see Part 7.
- Preferred air flow direction in contaminated environments.

# Servo Motors for SIMOVERT MASTERDRIVES

## Asynchronous Servo Motors

### 1PL6 Motors

#### Selection and Ordering Data with SIMOVERT MASTERDRIVES Vector Control

Rated Rotational Speed	Shaft Height	Rated Output	Rated Torque	Rated Current	Rated Voltage	Speed during Field Weakening <sup>1)</sup>	Max. Permissible Continuous Speed <sup>2)</sup>	Max. Speed <sup>3)</sup>	1PL6 Asynchronous Motors
$n_{rated}$		$P_{rated}$	$M_{rated}$	$I_{rated}$	$V_{rated}$	$n_1$	$n_{S1}$	$n_{max}$	Order No.
rpm	SH	kW (HP)	Nm (lb <sub>f</sub> -ft)	A	V	rpm	rpm	rpm	
<b>Supply voltage 3-ph. AC 400 V for SIMOVERT MASTERDRIVES Vector Control</b>									
<b>800</b>	280	195 (261.39)	2328 (1717.1)	335	400	1340	2200	3300	<b>1PL6 284 - ■ ■ C ■ ■ - 0 . . .</b>
		250 (335.12)	2984 (2201)	440	385	1450	2200	3300	<b>1PL6 286 - ■ ■ C ■ ■ - 0 . . .</b>
		310 (415.55)	3701 (2729.9)	570	370	1520	2200	3300	<b>1PL6 288 - ■ ■ C ■ ■ - 0 . . .</b>
<b>1150</b>	280	280 (375.33)	2325 (1714.9)	478	400	2200	2200	3300	<b>1PL6 284 - ■ ■ D ■ ■ - 0 . . .</b>
		355 (475.87)	2944 (2171.5)	637	380	2200	2200	3300	<b>1PL6 286 - ■ ■ D ■ ■ - 0 . . .</b>
		435 (583.11)	3607 (2660.5)	765	385	2200	2200	3300	<b>1PL6 288 - ■ ■ D ■ ■ - 0 . . .</b>
<b>1750</b>	280	370 (495.99)	2019 (1489.2)	616	400	2200	2200	3300	<b>1PL6 284 - ■ ■ F ■ ■ - 0 . . .</b>
		445 (596.51)	2429 (1791.6)	736	400	2200	2200	3300	<b>1PL6 286 - ■ ■ F ■ ■ - 0 . . .</b>
		560 (750.67)	3055 (2253.4)	924	400	2200	2200	3300	<b>1PL6 288 - ■ ■ F ■ ■ - 0 . . .</b>

• **Separate fan:**<sup>4)</sup>

- With separate fan, non-drive end on top, air flow non-drive end to drive end
- With separate fan, non-drive end on the right, air flow non-drive end to drive end
- With separate fan, non-drive end on the left, air flow non-drive end to drive end
- With separate fan, drive end on top, air flow drive end to non-drive end
- With separate fan, drive end on the right, air flow drive end to non-drive end
- With separate fan, drive end on the left, air flow drive end to non-drive end
- Without separate fan, for simple pipe connection on non-drive end on the right

0  
1  
2  
3  
4  
5  
6

• **Encoder:**

- Without encoder
- Incremental encoder HTL (1,024 pulses/revolution)
- Incremental encoder HTL (2,048 pulses/revolution)

A  
H  
J

• **Terminal box arrangement/direction of cable entry (drive-end view):**<sup>4)</sup>

- Terminal box non-drive side on right/cable entry on bottom/encoder connector on drive side
- Terminal box non-drive side on left/cable entry on bottom/encoder connector on drive side
- Terminal box non-drive side on top/cable entry on right/encoder connector on drive side
- Terminal box drive side on top/cable entry on right/encoder connector on non-drive side

0  
1  
2  
5

• **Construction type:**<sup>4)</sup>

- IM B3
- IM V5 (can be converted later to IM V6)
- IM B35 (with flange A 660)
- IM V15 (with flange A 660; can be converted later to IM V36)

0  
1  
3  
5

For order number supplements for drive type, direction of air flow, and paint finish (positions 14 through 16 of the order no.), see page 3/51.

3

# Servo Motors for SIMOVERT MASTERDRIVES

## Asynchronous Servo Motors

1PL6 Motors

### Selection and Ordering Data with SIMOVERT MASTERDRIVES Vector Control

Power Factor	Magnetizing Current $I_{\mu}$ A	Rated Efficiency $\eta_{rated}$	Rated Frequency $f_{rated}$ Hz	Moment of inertia $J$ kgm <sup>2</sup> (lb <sub>f</sub> -in-s <sup>2</sup> )	Weight, approx. kg (lb)	1PL6 Asynchronous Motors	SIMOVERT MASTERDRIVES VC Inverter/Converter Rated Current	
						Order No.	$I_{rated}$ A	Order No.
<b>Supply voltage 3-ph. AC 400 V for SIMOVERT MASTERDRIVES Vector Control</b>								
0.90	95	0.929	27.3	4.2 (37.1694)	1300 (2866.5)	1PL6 284 - . . . C . . . 0 ■■■■	370	6SE7 033 - 7 ■ G60
0.90	135	0.934	27.3	5.2 (46.0192)	1500 (3307.5)	1PL6 286 - . . . C . . . 0 ■■■■	510	6SE7 035 - 1 ■ K/J60
0.90	170	0.939	27.3	6.3 (55.754)	1700 (3748.5)	1PL6 288 - . . . C . . . 0 ■■■■	590	6SE7 036 - 0 ■ K/J60
0.89	156	0.950	38.9	4.2 (37.1694)	1300 (2866.5)	1PL6 284 - . . . D . . . 0 ■■■■	510	6SE7 035 - 1 ■ K/J60
0.89	214	0.953	38.9	5.2 (46.0192)	1500 (3307.5)	1PL6 286 - . . . D . . . 0 ■■■■	690	6SE7 037 - 0 ■ K/J60
0.89	248	0.955	38.9	6.3 (55.754)	1700 (3748.5)	1PL6 288 - . . . D . . . 0 ■■■■	860	6SE7 038 - 6 T K60
0.90	162	0.959	59.0	4.2 (37.1694)	1300 (2866.5)	1PL6 284 - . . . F . . . 0 ■■■■	690	6SE7 037 - 0 ■ K/J60
0.91	182	0.960	59.0	5.2 (46.0192)	1500 (3307.5)	1PL6 286 - . . . F . . . 0 ■■■■	860	6SE7 038 - 6 T K60
0.91	232	0.962	59.0	6.3 (55.754)	1700 (3748.5)	1PL6 288 - . . . F . . . 0 ■■■■	1100	6SE7 041 - 1 T K60
<ul style="list-style-type: none"> <li>• <b>Drive type:</b><sup>4)</sup> Coupling N Coupling R Belt/increased cantilever forces N Belt/increased cantilever forces R</li> <li>• <b>Vibration sev. grade:</b> N R N R</li> <li>• <b>Shaft and flange accuracy:</b> N R N R</li> </ul>						A B E F		
<ul style="list-style-type: none"> <li>• <b>Shaft end:</b> With keyway, half-key balancing With keyway, full-key balancing Without keyway</li> </ul>						A C J		
<ul style="list-style-type: none"> <li>• <b>Paint finish:</b> Primed Anthracite gray, standard finish (RAL 7016) Anthracite gray, special finish (RAL 7016)</li> </ul>						0 3 6		
<ul style="list-style-type: none"> <li>• <b>Special models:</b> Please specify additional order code and any required plain text; see Page 3/45.</li> </ul>						-Z		
Converter Inverter								E T

1)  $n_1$ : Maximum permissible speed at constant power or speed where for  $P = P_{rated}$ , there is still a 30% power reserve up to the stall limit.  
2)  $n_{S1}$ : Maximum permissible speed that is continuously permitted without speed duty cycles.

3)  $n_{max}$ : Maximum rotational speed. This speed may not be exceeded! Notice: Due to  $f_{max} < 5 \cdot f_{rated}$ , the maximum rotational speed is sometimes limited to smaller values.  
4) For possible combinations, refer to page 3/68.

3

# Servo Motors for SIMOVERT MASTERDRIVES

## Asynchronous Servo Motors

### 1PL6 Motors

#### Selection and Ordering Data with SIMOVERT MASTERDRIVES Vector Control

Rated Rotational Speed	Shaft Height	Rated Output	Rated Torque	Rated Current	Rated Voltage	Speed during Field Weakening <sup>1)</sup>	Max. Permissible Continuous Speed <sup>2)</sup>	Max. Speed <sup>3)</sup>	1PL6 Asynchronous Motors
$n_{rated}$		$P_{rated}$	$M_{rated}$	$I_{rated}$	$U_{rated}$	$n_1$	$n_{S1}$	$n_{max}$	Order No.
rpm	SH	kW (HP)	Nm (lb <sub>f</sub> -ft)	A	V	rpm	rpm	rpm	
<b>Supply voltage 3-ph. AC 480 V for SIMOVERT MASTERDRIVES Vector Control</b>									
<b>500</b>	180	30 (40.21)	573 (422.6)	66	370	1300	2500	2500	<b>1PL6 184 - ■ ■ B ■ ■ - 0 . . .</b>
		40 (53.62)	764 (563.5)	91	355	1500	2500	2500	<b>1PL6 186 - ■ ■ B ■ ■ - 0 . . .</b>
	225	55 (73.73)	1050 (774.5)	114	370	1300	2500	2500	<b>1PL6 224 - ■ ■ B ■ ■ - 0 . . .</b>
		72 (96.51)	1375 (1014.2)	147	375	1500	2500	2500	<b>1PL6 226 - ■ ■ B ■ ■ - 0 . . .</b>
		90 (120.64)	1719 (1267.9)	180	380	1400	2500	2500	<b>1PL6 228 - ■ ■ B ■ ■ - 0 . . .</b>
<b>1350</b>	180	74 (99.2)	523 (385.8)	119	460	2200	3500 <sup>4)</sup>	5000	<b>1PL6 184 - ■ ■ D ■ ■ - 0 . . .</b>
		98 (131.37)	693 (511.2)	156	460	2400	3500 <sup>4)</sup>	5000	<b>1PL6 186 - ■ ■ D ■ ■ - 0 . . .</b>
	225	137 (183.65)	969 (714.7)	215	460	2500	3100 <sup>4)</sup>	4500	<b>1PL6 224 - ■ ■ D ■ ■ - 0 . . .</b>
		172 (230.56)	1217 (897.7)	265	460	2500	3100 <sup>4)</sup>	4500	<b>1PL6 226 - ■ ■ D ■ ■ - 0 . . .</b>
		218 (292.23)	1542 (1137.4)	332	460	2200	3100 <sup>4)</sup>	4500 <sup>4)</sup>	<b>1PL6 228 - ■ ■ D ■ ■ - 0 . . .</b>

**• Separate fan:**

- With separate fan
- Without separate fan, for pipe connection
- With separate fan, but with metric cable entries in accordance with EN 50262
- Without separate fan, for pipe connection, but with metric cable entries in accordance with EN 50262

4  
6  
7  
8

**• Encoder:**

- Without encoder
- Incremental encoder HTL (1,024 pulses/revolution)
- Incremental encoder HTL (2,048 pulses/revolution)

A  
H  
J

**• Terminal box arrangement/direction of cable entry (drive-end view):**

- On top/from right
- On top/from drive end
- On top/from non-drive end
- On top/from left

0  
1  
2  
3

**• Construction type:**

- IM B3
  - IM B3
  - IM B35 (SH 180: With flange A 450, SH 225: With flange A 550)
  - IM B35 (SH 180: With flange A 450, SH 225: With flange A 550)
- Hoisting concept for other construction types (IM B6, IM B7, IM B8, IM V5, IM V6)
- Hoisting concept for other construction types (IM V15, IM V36)

0  
1  
3  
5

For order number supplements for drive type, direction of air flow, and paint finish (positions 14 through 16 of the order no.), see page 3/53.

# Servo Motors for SIMOVERT MASTERDRIVES

## Asynchronous Servo Motors

1PL6 Motors

3

### Selection and Ordering Data with SIMOVERT MASTERDRIVES Vector Control

Power Factor	Magnetizing Current $I_{\mu}$ A	Rated Efficiency $\eta_{rated}$	Rated Frequency $f_{rated}$ Hz	Moment of inertia $J$ kgm <sup>2</sup> (lb <sub>f</sub> -in-s <sup>2</sup> )	Weight, approx. kg (lb)	1PL6 Asynchronous Motors	SIMOVERT MASTERDRIVES VC Inverter/Converter Rated Current	
						Order No.	$I_{rated}$ A	Order No.
<b>Supply voltage 3-ph. AC 480 V for SIMOVERT MASTERDRIVES Vector Control</b>								
0.84	34	0.844	17.6	0.503 (4.4545)	370 (815.8)	1PL6 184 - . . B . . - 0 ■■■■	72	6SE7 027 - 2 ■ D61
0.84	46	0.845	17.6	0.666 (5.894)	440 (970.2)	1PL6 186 - . . B . . - 0 ■■■■	92	6SE7 031 - 0 ■ E60
0.86	46	0.875	17.5	1.479 (13.0889)	630 (1389.2)	1PL6 224 - . . B . . - 0 ■■■■	124	6SE7 031 - 2 ■ F60
0.85	66	0.887	17.4	1.930 (17.0802)	750 (1653.8)	1PL6 226 - . . B . . - 0 ■■■■	146	6SE7 031 - 5 ■ F60
0.85	79	0.894	17.4	2.326 (20.5848)	860 (1896.3)	1PL6 228 - . . B . . - 0 ■■■■	186	6SE7 031 - 8 ■ F60
0.86	44	0.918	46.1	0.503 (4.4545)	370 (815.8)	1PL6 184 - . . D . . - 0 ■■■■	124	6SE7 031 - 2 ■ F60
0.85	60	0.920	46.0	0.666 (5.894)	440 (970.2)	1PL6 186 - . . D . . - 0 ■■■■	186	6SE7 031 - 8 ■ F60
0.85	82	0.940	45.8	1.479 (13.0889)	630 (1389.2)	1PL6 224 - . . D . . - 0 ■■■■	260	6SE7 032 - 6 ■ G60
0.87	88	0.940	45.8	1.930 (17.0802)	750 (1653.8)	1PL6 226 - . . D . . - 0 ■■■■	315	6SE7 033 - 2 ■ G60
0.88	100	0.938	45.8	2.326 (20.5848)	860 (1896.3)	1PL6 228 - . . D . . - 0 ■■■■	370	6SE7 033 - 7 ■ G60
<ul style="list-style-type: none"> <li><b>Drive type:</b> <ul style="list-style-type: none"> <li>Coupling R</li> <li>Coupling R</li> <li>Coupling S</li> <li>Coupling SR</li> <li>Belt R</li> <li>Belt R</li> <li>Increased cantilever forces R</li> <li>Increased cantilever forces R</li> </ul> </li> <li><b>Vibration sev. grade:</b> <ul style="list-style-type: none"> <li>R</li> <li>R</li> <li>R</li> <li>R</li> <li>N</li> <li>R</li> <li>N</li> <li>R</li> </ul> </li> <li><b>Shaft and flange accuracy:</b> <ul style="list-style-type: none"> <li>N</li> <li>R</li> <li>R</li> <li>R</li> <li>N</li> <li>R</li> <li>N</li> <li>R</li> </ul> </li> </ul>						A B C D E F G H		
<ul style="list-style-type: none"> <li><b>Direction of air flow:</b> <ul style="list-style-type: none"> <li>DE → NDE</li> <li>NDE → DE<sup>5</sup>)</li> <li>DE → NDE</li> <li>NDE → DE<sup>5</sup>)</li> <li>DE → NDE</li> <li>NDE → DE<sup>5</sup>)</li> </ul> </li> <li><b>Shaft end:</b> <ul style="list-style-type: none"> <li>With keyway, half-key balancing</li> <li>With keyway, half-key balancing</li> <li>With keyway, full-key balancing</li> <li>With keyway, full-key balancing</li> <li>Without keyway</li> <li>Without keyway</li> </ul> </li> </ul>						A B C D J K		
<ul style="list-style-type: none"> <li><b>Paint finish:</b> <ul style="list-style-type: none"> <li>Primed</li> <li>Anthracite gray, standard finish (RAL 7016)</li> <li>Anthracite gray, special finish (RAL 7016)</li> </ul> </li> </ul>						0 3 6		
<ul style="list-style-type: none"> <li><b>Special models:</b> <ul style="list-style-type: none"> <li>Please specify additional order code and any required plain text; see Page 3/45.</li> </ul> </li> </ul>						-Z		
<ul style="list-style-type: none"> <li>Converter</li> <li>Inverter</li> </ul>						E T		

- $n_1$ : Maximum permissible speed at constant power or speed where for  $P = P_{rated}$ , there is still a 30% power reserve up to the stall limit.
- $n_{S1}$ : Maximum permissible speed that is continuously permitted without speed duty cycles.
- $n_{max}$ : Maximum rotational speed. This speed may not be exceeded! Notice: Due to  $f_{max} < 5 \cdot f_{rated}$ , the maximum rotational speed is sometimes limited to smaller values.
- Rotational speed is reduced in the event of increased cantilever forces, see Part 7.
- Preferred air flow direction in contaminated environments.



# Servo Motors for SIMOVERT MASTERDRIVES

## Asynchronous Servo Motors

### 1PL6 Motors

#### Selection and Ordering Data with SIMOVERT MASTERDRIVES Vector Control (continued)

Rated Rotational Speed	Shaft Height	Rated Output	Rated Torque	Rated Current	Rated Voltage	Speed during Field Weakening <sup>1)</sup>	Max. Permissible Continuous Speed <sup>2)</sup>	Max. Speed <sup>3)</sup>	1PL6 Asynchronous Motors
$n_{rated}$		$P_{rated}$	$M_{rated}$	$I_{rated}$	$V_{rated}$	$n_1$	$n_{S1}$	$n_{max}$	Order No.
rpm	SH	kW (HP)	Nm (lb <sub>f</sub> -ft)	A	V	rpm	rpm	rpm	
<b>Supply voltage 3-ph. AC 480 V for SIMOVERT MASTERDRIVES Vector Control</b>									
<b>2000</b>	180	98 (131.37)	468 (345.2)	161	460	4200	3500 <sup>4)</sup>	5000	<b>1PL6 184 - ■ ■ F ■ ■ - 0 . . .</b>
		135 (180.97)	645 (475.8)	220	460	4200	3500 <sup>4)</sup>	5000	<b>1PL6 186 - ■ ■ F ■ ■ - 0 . . .</b>
	225	178 (238.61)	850 (627)	275	460	2900	3100 <sup>4)</sup>	4500	<b>1PL6 224 - ■ ■ F ■ ■ - 0 . . .</b>
		220 (294.91)	1050 (774.5)	342	460	2900	3100 <sup>4)</sup>	4500	<b>1PL6 226 - ■ ■ F ■ ■ - 0 . . .</b>
		288 (386.06)	1375 (1014.2)	450	460	2900	3100 <sup>4)</sup>	4500 <sup>4)</sup>	<b>1PL6 228 - ■ ■ F ■ ■ - 0 . . .</b>
<b>2900</b>	180	113 (151.47)	372 (274.4)	209	400	5000	3500 <sup>4)</sup>	5000	<b>1PL6 184 - ■ ■ L ■ ■ - 0 . . .</b>
		150 (201.07)	494 (364.4)	280	390	5000	3500 <sup>4)</sup>	5000	<b>1PL6 186 - ■ ■ L ■ ■ - 0 . . .</b>
	225	205 (274.8)	675 (497.9)	365	400	3500	3100 <sup>4)</sup>	4500	<b>1PL6 224 - ■ ■ L ■ ■ - 0 . . .</b>
		270 (361.93)	889 (655.7)	470	395	3500	3100 <sup>4)</sup>	4500	<b>1PL6 226 - ■ ■ L ■ ■ - 0 . . .</b>
		300 (402.14)	988 (728.7)	530	400	3500	3100 <sup>4)</sup>	4500 <sup>4)</sup>	<b>1PL6 228 - ■ ■ L ■ ■ - 0 . . .</b>

**• Separate fan:**

- With separate fan
- Without separate fan, for pipe connection
- With separate fan, but with metric cable entries in accordance with EN 50262
- Without separate fan, for pipe connection, but with metric cable entries in accordance with EN 50262

4  
6  
7  
8

**• Encoder:**

- Without encoder
- Incremental encoder HTL (1,024 pulses/revolution)
- Incremental encoder HTL (2,048 pulses/revolution)

A  
H  
J

**• Terminal box arrangement/direction of cable entry (drive-end view):**

- On top/from right
- On top/from drive end
- On top/from non-drive end
- On top/from left

0  
1  
2  
3

**• Construction type:**

- IM B3
  - IM B3
  - IM B35 (SH 180: With flange A 450, SH 225: With flange A 550)
  - IM B35 (SH 180: With flange A 450, SH 225: With flange A 550)
- Hoisting concept for other construction types (IM B6, IM B7, IM B8, IM V5, IM V6)
- Hoisting concept for other construction types (IM V15, IM V36)

0  
1  
3  
5

For order number supplements for drive type, direction of air flow, and paint finish (positions 14 through 16 of the order no.), see page 3/55.

# Servo Motors for SIMOVERT MASTERDRIVES

## Asynchronous Servo Motors

1PL6 Motors

### Selection and Ordering Data with SIMOVERT MASTERDRIVES Vector Control (continued)

Power Factor	Magnetizing Current $I_{\mu}$ A	Rated Efficiency $\eta_{rated}$	Rated Frequency $f_{rated}$ Hz	Moment of inertia $J$ kgm <sup>2</sup> (lb <sub>f</sub> -in-s <sup>2</sup> )	Weight, approx. kg (lb)	1PL6 Asynchronous Motors		SIMOVERT MASTERDRIVES VC Inverter/Converter Rated Current	
						Order No.	$I_{rated}$ A	Order No.	
<b>Supply voltage 3-ph. AC 480 V for SIMOVERT MASTERDRIVES Vector Control</b>									
0.83	70	0.934	67.5	0.503 (4.4545)	370 (815.8)	1PL6 184 - . . F . . - 0 ■■■■	186	6SE7 031 - 8 ■ F60	
0.83	94	0.94	67.5	0.666 (5.894)	440 (970.2)	1PL6 186 - . . F . . - 0 ■■■■	260	6SE7 032 - 6 ■ G60	
0.86	91	0.944	67.5	1.479 (13.0889)	630 (1389.2)	1PL6 224 - . . F . . - 0 ■■■■	315	6SE7 033 - 2 ■ G60	
0.86	124	0.948	67.5	1.930 (17.0802)	750 (1653.8)	1PL6 226 - . . F . . - 0 ■■■■	370	6SE7 033 - 7 ■ G60	
0.85	176	0.948	67.3	2.326 (20.5848)	860 (1896.3)	1PL6 228 - . . F . . - 0 ■■■■	510	6SE7 035 - 1 ■ K/J60	
0.85	79	0.938	97.6	0.503 (4.4545)	370 (815.8)	1PL6 184 - . . L . . - 0 ■■■■	210	6SE7 032 - 1 ■ G60	
0.84	110	0.943	97.5	0.666 (5.894)	440 (970.2)	1PL6 186 - . . L . . - 0 ■■■■	315	6SE7 033 - 2 ■ G60	
0.86	118	0.950	97.5	1.479 (13.0889)	630 (1389.2)	1PL6 224 - . . L . . - 0 ■■■■	370	6SE7 033 - 7 ■ G60	
0.87	160	0.952	97.4	1.930 (17.0802)	750 (1653.8)	1PL6 226 - . . L . . - 0 ■■■■	510	6SE7 035 - 1 ■ K/J60	
0.86	188	0.952	97.3	2.326 (20.5848)	860 (1896.3)	1PL6 228 - . . L . . - 0 ■■■■	590	6SE7 036 - 0 ■ K/J60	
<ul style="list-style-type: none"> <li><b>Drive type:</b> <ul style="list-style-type: none"> <li>Coupling R</li> <li>Coupling R</li> <li>Coupling S</li> <li>Coupling SR</li> <li>Belt R</li> <li>Belt R</li> <li>Increased cantilever forces R</li> <li>Increased cantilever forces R</li> </ul> </li> <li><b>Vibration sev. grade:</b> <ul style="list-style-type: none"> <li>R</li> <li>R</li> <li>R</li> <li>R</li> <li>N</li> <li>R</li> <li>N</li> <li>R</li> </ul> </li> <li><b>Shaft and flange accuracy:</b> <ul style="list-style-type: none"> <li>N</li> <li>R</li> <li>R</li> <li>R</li> <li>N</li> <li>R</li> <li>N</li> <li>R</li> </ul> </li> </ul>						A B C D E F G H			
<ul style="list-style-type: none"> <li><b>Direction of air flow:</b> <ul style="list-style-type: none"> <li>DE → NDE</li> <li>NDE → DE<sup>5)</sup></li> <li>DE → NDE</li> <li>NDE → DE<sup>5)</sup></li> <li>DE → NDE</li> <li>NDE → DE<sup>5)</sup></li> </ul> </li> <li><b>Shaft end:</b> <ul style="list-style-type: none"> <li>With keyway, half-key balancing</li> <li>With keyway, half-key balancing</li> <li>With keyway, full-key balancing</li> <li>With keyway, full-key balancing</li> <li>Without keyway</li> <li>Without keyway</li> </ul> </li> </ul>						A B C D J K			
<ul style="list-style-type: none"> <li><b>Paint finish:</b> <ul style="list-style-type: none"> <li>Primed</li> <li>Anthracite gray, standard finish (RAL 7016)</li> <li>Anthracite gray, special finish (RAL 7016)</li> </ul> </li> </ul>						0 3 6			
<ul style="list-style-type: none"> <li><b>Special models:</b> <ul style="list-style-type: none"> <li>Please specify additional order code and any required plain text; see Page 3/45.</li> </ul> </li> </ul>						-Z			
<ul style="list-style-type: none"> <li>Converter</li> <li>Inverter</li> </ul>								E T	

- $n_1$ : Maximum permissible speed at constant power or speed where for  $P = P_{rated}$ , there is still a 30% power reserve up to the stall limit.
- $n_{S1}$ : Maximum permissible speed that is continuously permitted without speed duty cycles.
- $n_{max}$ : Maximum rotational speed. This speed may not be exceeded! Notice: Due to  $f_{max} < 5 \cdot f_{rated}$ , the maximum rotational speed is sometimes limited to smaller values.
- Rotational speed is reduced in the event of increased cantilever forces, see Part 7.
- Preferred air flow direction in contaminated environments.

3

# Servo Motors for SIMOVERT MASTERDRIVES

## Asynchronous Servo Motors

### 1PL6 Motors

3

#### Selection and Ordering Data with SIMOVERT MASTERDRIVES Vector Control

Rated Rotational Speed	Shaft Height	Rated Output	Rated Torque	Rated Current	Rated Voltage	Speed during Field Weakening <sup>1)</sup>	Max. Permissible Continuous Speed <sup>2)</sup>	Max. Speed <sup>3)</sup>	1PL6 Asynchronous Motors
$n_{rated}$		$P_{rated}$	$M_{rated}$	$I_{rated}$	$V_{rated}$	$n_1$	$n_{S1}$	$n_{max}$	Order No.
rpm	SH	kW (HP)	Nm (lb <sub>f</sub> -ft)	A	V	rpm	rpm	rpm	
<b>Supply voltage 3-ph. AC 480 V for SIMOVERT MASTERDRIVES Vector Control</b>									
1000	280	235 (315.01)	2244 (1655.2)	335	480	1700	2200	3300	1PL6 284 - ■ ■ C ■ ■ - 0 . . .
		310 (415.55)	2961 (2184)	440	480	2000	2200	3300	1PL6 286 - ■ ■ C ■ ■ - 0 . . .
		385 (516.09)	3677 (2712.2)	570	460	2050	2200	3300	1PL6 288 - ■ ■ C ■ ■ - 0 . . .
1350	280	325 (435.66)	2299 (1695.7)	478	470	2200	2200	3300	1PL6 284 - ■ ■ D ■ ■ - 0 . . .
		410 (549.6)	2901 (2139.8)	637	445	2200	2200	3300	1PL6 286 - ■ ■ D ■ ■ - 0 . . .
		505 (676.94)	3573 (2635.4)	765	450	2200	2200	3300	1PL6 288 - ■ ■ D ■ ■ - 0 . . .
2000	280	415 (556.3)	1981 (1461.2)	616	455	2200	2200	3300	1PL6 284 - ■ ■ F ■ ■ - 0 . . .
		500 (670.24)	2387 (1760.7)	736	455	2200	2200	3300	1PL6 286 - ■ ■ F ■ ■ - 0 . . .
		630 (844.5)	3009 (2219.4)	924	455	2200	2200	3300	1PL6 288 - ■ ■ F ■ ■ - 0 . . .

- Separate fan:<sup>4)</sup>**
  - With separate fan, non-drive end on top, air flow non-drive end to drive end
  - With separate fan, non-drive end on the right, air flow non-drive end to drive end
  - With separate fan, non-drive end on the left, air flow non-drive end to drive end
  - With separate fan, drive end on top, air flow drive end to non-drive end
  - With separate fan, drive end on the right, air flow drive end to non-drive end
  - With separate fan, drive end on the left, air flow drive end to non-drive end
  - Without separate fan, for simple pipe connection on non-drive end on the right
- Encoder:**
  - Without encoder
  - Incremental encoder HTL (1,024 pulses/revolution)
  - Incremental encoder HTL (2,048 pulses/revolution)
- Terminal box arrangement/direction of cable entry (drive-end view):<sup>4)</sup>**
  - Terminal box non-drive side on right/cable entry on bottom/encoder connector on drive side
  - Terminal box non-drive side on left/cable entry on bottom/encoder connector on drive side
  - Terminal box non-drive side on top/cable entry on right/encoder connector on drive side
  - Terminal box drive side on top/cable entry on right/encoder connector on non-drive side
- Construction type:**
  - IM B3
  - IM V5 (can be converted later to IM V6)
  - IM B35 (with flange A 660)
  - IM V15 (with flange A 660; can be converted later to IM V36)

For order number supplements for drive type, direction of air flow, and paint finish (positions 14 through 16 of the order no.), see page 3/57.

# Servo Motors for SIMOVERT MASTERDRIVES

## Asynchronous Servo Motors

1PL6 Motors

3

### Selection and Ordering Data with SIMOVERT MASTERDRIVES Vector Control

Power Factor	Magnetizing Current $I_{\mu}$ A	Rated Efficiency $\eta_{rated}$	Rated Frequency $f_{rated}$ Hz	Moment of inertia $J$ kgm <sup>2</sup> (lb <sub>f</sub> -in-s <sup>2</sup> )	Weight, approx. kg (lb)	1PL6 Asynchronous Motors	SIMOVERT MASTERDRIVES VC Inverter/Converter Rated Current	
						Order No.	$I_{rated}$ A	Order No.
<b>Supply voltage 3-ph. AC 480 V for SIMOVERT MASTERDRIVES Vector Control</b>								
0.90	90	0.939	34.0	4.2 (37.1694)	1300 (2866.5)	1PL6 284 - . . . C . . . - 0 ■■■■	370	6SE7 033 - 7 ■ G60
0.90	135	0.945	34.0	5.2 (46.0192)	1500 (3307.5)	1PL6 286 - . . . C . . . - 0 ■■■■	510	6SE7 035 - 1 ■ K/J60
0.90	170	0.948	34.0	6.3 (55.754)	1700 (3748.5)	1PL6 288 - . . . C . . . - 0 ■■■■	590	6SE7 036 - 0 ■ K/J60
0.89	157	0.955	45.5	4.2 (37.1694)	1300 (2866.5)	1PL6 284 - . . . D . . . - 0 ■■■■	510	6SE7 035 - 1 ■ K/J60
0.89	215	0.957	45.5	5.2 (46.0192)	1500 (3307.5)	1PL6 286 - . . . D . . . - 0 ■■■■	690	6SE7 037 - 0 ■ K/J60
0.89	248	0.959	45.5	6.3 (55.754)	1700 (3748.5)	1PL6 288 - . . . D . . . - 0 ■■■■	860	6SE7 038 - 6 T K60
0.90	161	0.961	67.3	4.2 (37.1694)	1300 (2866.5)	1PL6 284 - . . . F . . . - 0 ■■■■	690	6SE7 037 - 0 ■ K/J60
0.91	181	0.963	67.3	5.2 (46.0192)	1500 (3307.5)	1PL6 286 - . . . F . . . - 0 ■■■■	860	6SE7 038 - 6 T K60
0.91	231	0.965	67.3	6.3 (55.754)	1700 (3748.5)	1PL6 288 - . . . F . . . - 0 ■■■■	1100	6SE7 041 - 1 T K60
<ul style="list-style-type: none"> <li>• <b>Drive type:</b><sup>4)</sup> Coupling N Coupling R Belt/increased cantilever forces N Belt/increased cantilever forces R</li> <li>• <b>Vibration sev. grade:</b> N R N R</li> <li>• <b>Shaft and flange accuracy:</b> N R N R</li> </ul>						A B E F		
<ul style="list-style-type: none"> <li>• <b>Shaft end:</b> With keyway, half-key balancing With keyway, full-key balancing Without keyway</li> </ul>						A C J		
<ul style="list-style-type: none"> <li>• <b>Paint finish:</b> Primed Anthracite gray, standard finish (RAL 7016) Anthracite gray, special finish (RAL 7016)</li> </ul>						0 3 6		
<ul style="list-style-type: none"> <li>• <b>Special models:</b> Please specify additional order code and any required plain text; see Page 3/45.</li> </ul>						-Z		
Converter Inverter								E T

1)  $n_1$ : Maximum permissible speed at constant power or speed where for  $P = P_{rated}$ , there is still a 30% power reserve up to the stall limit.  
2)  $n_{S1}$ : Maximum permissible speed that is continuously permitted without speed duty cycles.

3)  $n_{max}$ : Maximum rotational speed. This speed may not be exceeded! Notice: Due to  $f_{max} < 5 \cdot f_{rated}$ , the maximum rotational speed is sometimes limited to smaller values.  
4) For possible combinations, refer to page 3/68.

# Servo Motors for SIMOVERT MASTERDRIVES

## Asynchronous Servo Motors

### 1PL6 Motors

3

#### Selection and Ordering Data with SIMOVERT MASTERDRIVES Vector Control

Rated Rotational Speed	Shaft Height	Rated Output	Rated Torque	Rated Current	Rated Voltage	Speed during Field Weakening <sup>1)</sup>	Max. Permissible Continuous Speed <sup>2)</sup>	Max. Speed <sup>3)</sup>	1PL6 Asynchronous Motors
$n_{rated}$		$P_{rated}$	$M_{rated}$	$I_{rated}$	$V_{rated}$	$n_1$	$n_{S1}$	$n_{max}$	Order No.
rpm	SH	kW (HP)	Nm (lb <sub>f</sub> -ft)	A	V	rpm	rpm	rpm	
<b>Supply voltage 3-ph. AC 690 V for SIMOVERT MASTERDRIVES Vector Control (Option C30)</b>									
<b>800</b>	280	185 (247.99)	2208 (1628.6)	185	690	1440	2200	3300	<b>1PL6 284 - ■ ■ C ■ ■ - 0 . . .</b>
		240 (321.72)	2865 (2113.2)	250	665	1550	2200	3300	<b>1PL6 286 - ■ ■ C ■ ■ - 0 . . .</b>
		300 (402.14)	3581 (2641.3)	320	640	1600	2200	3300	<b>1PL6 288 - ■ ■ C ■ ■ - 0 . . .</b>
<b>1150</b>	280	272 (364.61)	2259 (1666.2)	270	690	2200	2200	3300	<b>1PL6 284 - ■ ■ D ■ ■ - 0 . . .</b>
		344 (461.13)	2857 (2107.3)	359	655	2200	2200	3300	<b>1PL6 286 - ■ ■ D ■ ■ - 0 . . .</b>
		422 (565.68)	3504 (2584.6)	431	665	2200	2200	3300	<b>1PL6 288 - ■ ■ D ■ ■ - 0 . . .</b>
<b>1750</b>	280	359 (481.23)	1959 (1445)	347	690	2200	2200	3300	<b>1PL6 284 - ■ ■ F ■ ■ - 0 . . .</b>
		432 (579.09)	2357 (1738.5)	415	690	2200	2200	3300	<b>1PL6 286 - ■ ■ F ■ ■ - 0 . . .</b>
		543 (727.88)	2963 (2185.5)	520	690	2200	2200	3300	<b>1PL6 288 - ■ ■ F ■ ■ - 0 . . .</b>

- Separate fan:<sup>5)</sup>**
  - With separate fan, non-drive end on top, air flow non-drive end to drive end
  - With separate fan, non-drive end on the right, air flow non-drive end to drive end
  - With separate fan, non-drive end on the left, air flow non-drive end to drive end
  - With separate fan, drive end on top, air flow drive end to non-drive end
  - With separate fan, drive end on the right, air flow drive end to non-drive end
  - With separate fan, drive end on the left, air flow drive end to non-drive end
  - Without separate fan, for simple pipe connection on non-drive end on the right
- Encoder:**
  - Without encoder
  - Incremental encoder HTL (1,024 pulses/revolution)
  - Incremental encoder HTL (2,048 pulses/revolution)
- Terminal box arrangement/direction of cable entry (drive-end view):<sup>5)</sup>**
  - Terminal box non-drive side on right/cable entry on bottom/encoder connector on drive side
  - Terminal box non-drive side on left/cable entry on bottom/encoder connector on drive side
  - Terminal box non-drive side on top/cable entry on right/encoder connector on drive side
  - Terminal box drive side on top/cable entry on right/encoder connector on non-drive side
- Construction type:<sup>5)</sup>**
  - IM B3
  - IM V5 (can be converted later to IM V6)
  - IM B35 (with flange A 660)
  - IM V15 (with flange A 660; can be converted later to IM V36)

For order number supplements for drive type, direction of air flow, and paint finish (positions 14 through 16 of the order no.), see page 3/59.

# Servo Motors for SIMOVERT MASTERDRIVES

## Asynchronous Servo Motors

1PL6 Motors

### Selection and Ordering Data with SIMOVERT MASTERDRIVES Vector Control

Power Factor	Magnetizing Current $I_{\mu}$ A	Rated Efficiency $\eta_{rated}$	Rated Frequency $f_{rated}$ Hz	Moment of inertia $J$ kgm <sup>2</sup> (lb <sub>f</sub> -in-s <sup>2</sup> )	Weight, approx. kg (lb)	1PL6 Asynchronous Motors	SIMOVERT MASTERDRIVES VC Inverter/Converter Rated Current	
						Order No.	$I_{rated}$ A	Order No.
<b>Supply voltage 3-ph. AC 690 V for SIMOVERT MASTERDRIVES Vector Control (Option C30)</b>								
0.90	55	0.928	27.0	4.2 (37.1694)	1300 (2866.5)	1PL6 284 - . . . C . . - 0 ■■■■	208	6SE7 032 - 0 ■ G60
0.90	80	0.934	27.0	5.2 (46.0192)	1500 (3307.5)	1PL6 286 - . . . C . . - 0 ■■■■	297	6SE7 033 - 0 ■ K/J60
0.90	100	0.938	27.0	6.3 (55.754)	1700 (3748.5)	1PL6 288 - . . . C . . - 0 ■■■■	354	6SE7 033 - 5 ■ K/J60
0.89	89	0.949	38.9	4.2 (37.1694)	1300 (2866.5)	1PL6 284 - . . . D . . - 0 ■■■■	297	6SE7 033 - 0 ■ K/J60
0.89	123	0.953	38.9	5.2 (46.0192)	1500 (3307.5)	1PL6 286 - . . . D . . - 0 ■■■■	354 <sup>4)</sup>	6SE7 033 - 5 ■ K/J60
0.89	143	0.955	38.9	6.3 (55.754)	1700 (3748.5)	1PL6 288 - . . . D . . - 0 ■■■■	452	6SE7 034 - 5 ■ K/J60
0.90	93	0.958	59.0	4.2 (37.1694)	1300 (2866.5)	1PL6 284 - . . . F . . - 0 ■■■■	354	6SE7 033 - 5 ■ K/J60
0.91	105	0.960	59.0	5.2 (46.0192)	1500 (3307.5)	1PL6 286 - . . . F . . - 0 ■■■■	452	6SE7 034 - 5 ■ K/J60
0.91	133	0.962	59.0	6.3 (55.754)	1700 (3748.5)	1PL6 288 - . . . F . . - 0 ■■■■	570	6SE7 035 - 7 U K60
<b>• Drive type:<sup>5)</sup></b>		<b>• Vibration sev. grade:</b>		<b>• Shaft and flange accuracy:</b>				
Coupling		N		N		A		
Coupling		R		R		B		
Belt/increased cantilever forces		N		N		E		
Belt/increased cantilever forces		R		R		F		
<b>• Shaft end:</b>						A		
With keyway, half-key balancing						C		
With keyway, full-key balancing						J		
Without keyway								
<b>• Paint finish:</b>						0		
Primed						3		
Anthracite gray, standard finish (RAL 7016)						6		
Anthracite gray, special finish (RAL 7016)								
<b>• Special models:</b>						-C30		
Please specify additional order code and any required plain text; see Page 3/45.								
Converter						H		
Inverter						W		

3

1)  $n_1$ : Maximum permissible speed at constant power or speed where for  $P = P_{rated}$ , there is still a 30% power reserve up to the stall limit.  
 2)  $n_{S1}$ : Maximum permissible speed that is continuously permitted without speed duty cycles.  
 3)  $n_{max}$ : Maximum rotational speed. This speed may not be exceeded!  
 Notice: Due to  $f_{max} < 5 \cdot f_{rated}$ , the maximum rotational speed is sometimes limited to smaller values.

4) Notice: The rated converter current is smaller than the rated motor current.  
 5) For possible combinations, refer to page 3/68.

# Servo Motors for SIMOVERT MASTERDRIVES

## Asynchronous Servo Motors

### 1PL6 Motors

3

#### Selection and Ordering Data with SIMOVERT MASTERDRIVES Motion Control

Rated Rotational Speed	Shaft Height	Rated Output	Rated Torque	Rated Current	Rated Voltage	Speed during Field Weakening <sup>1)</sup>	Max. Permissible Continuous Speed <sup>2)</sup>	Max. Speed <sup>3)</sup>	1PL6 Asynchronous Motors
$n_{rated}$		$P_{rated}$	$M_{rated}$	$I_{rated}$	$V_{rated}$	$n_1$	$n_{S1}$	$n_{max}$	Order No.
rpm	SH	kW (HP)	Nm (lb <sub>f</sub> -ft)	A	V	rpm	rpm	rpm	
<b>Supply voltage 3-ph. AC 400 V for SIMOVERT MASTERDRIVES Motion Control</b>									
<b>400</b>	180	20.5 (27.48)	489 (360.7)	58	290	800	800	800	<b>1PL6 184 - ■ ■ B ■ ■ - 0 ...</b>
		30.5 (40.88)	728 (537)	87	290	800	800	800	<b>1PL6 186 - ■ ■ B ■ ■ - 0 ...</b>
	225	40 (53.62)	955 (704.4)	105	296	800	800	800	<b>1PL6 224 - ■ ■ B ■ ■ - 0 ...</b>
		57 (76.41)	1361 (1003.9)	145	305	800	800	800	<b>1PL6 226 - ■ ■ B ■ ■ - 0 ...</b>
		72 (96.51)	1719 (1267.9)	181	305	800	800	800	<b>1PL6 228 - ■ ■ B ■ ■ - 0 ...</b>
<b>1000</b>	180	57 (76.41)	544 (401.3)	122	345	1300	2000	2000	<b>1PL6 184 - ■ ■ D ■ ■ - 0 ...</b>
		74 (99.2)	707 (521.5)	157	345	1600	2000	2000	<b>1PL6 186 - ■ ■ D ■ ■ - 0 ...</b>
	225	105 (140.75)	1003 (739.8)	220	345	1700	2000	2000	<b>1PL6 224 - ■ ■ D ■ ■ - 0 ...</b>
		135 (180.97)	1289 (213.2)	278	345	1700	2000	2000	<b>1PL6 226 - ■ ■ D ■ ■ - 0 ...</b>
		165 (221.18)	1576 (1162.5)	331	348	1700	2000	2000	<b>1PL6 228 - ■ ■ D ■ ■ - 0 ...</b>
<b>1500</b>	180	76 (101.88)	484 (357)	165	345	3000	3000	3000	<b>1PL6 184 - ■ ■ F ■ ■ - 0 ...</b>
		108 (144.77)	688 (507.5)	233	340	3000	3000	3000	<b>1PL6 186 - ■ ■ F ■ ■ - 0 ...</b>
	225	142 (190.35)	904 (666.8)	292	345	2500	3000	3000	<b>1PL6 224 - ■ ■ F ■ ■ - 0 ...</b>
		175 (234.58)	1114 (821.7)	356	345	3000	3000 <sup>4)</sup>	3000	<b>1PL6 226 - ■ ■ F ■ ■ - 0 ...</b>
		230 (308.31)	1465 (1080.6)	468	345	2900	3000 <sup>4)</sup>	3000	<b>1PL6 228 - ■ ■ F ■ ■ - 0 ...</b>

<ul style="list-style-type: none"> <li><b>Separate fan:</b> <ul style="list-style-type: none"> <li>With separate fan</li> <li>Without separate fan, for pipe connection</li> <li>With separate fan, but with metric cable entries in accordance with EN 50262</li> <li>Without separate fan, for pipe connection, but with metric cable entries in accordance with EN 50262</li> </ul> </li> </ul>	4 6 7 8
<ul style="list-style-type: none"> <li><b>Encoder:</b> <ul style="list-style-type: none"> <li>Absolute encoder EnDat 2,048 pulses/revolution</li> <li>Incremental encoder sin/cos 1 V<sub>pp</sub> (without C track or D track)</li> <li>Incremental encoder sin/cos 1 V<sub>pp</sub> (with C track and D track)</li> <li>Resolver, 2-pole</li> </ul> </li> </ul>	E N M R
<ul style="list-style-type: none"> <li><b>Terminal box arrangement/direction of cable entry (drive-end view):</b> <ul style="list-style-type: none"> <li>On top/from right</li> <li>On top/from drive end</li> <li>On top/from non-drive end</li> <li>On top/from left</li> </ul> </li> </ul>	0 1 2 3
<ul style="list-style-type: none"> <li><b>Construction type:</b> <ul style="list-style-type: none"> <li>IM B3</li> <li>IM B3</li> <li>IM B35 (SH 180: With flange A 450, SH 225: With flange A 550)</li> <li>IM B35 (SH 180: With flange A 450, SH 225: With flange A 550)</li> </ul> </li> </ul>	0 1 3 5

For order number supplements for drive type, direction of air flow, and paint finish (positions 14 through 16 of the order no.), see page 3/61.

# Servo Motors for SIMOVERT MASTERDRIVES

## Asynchronous Servo Motors

1PL6 Motors

### Selection and Ordering Data with SIMOVERT MASTERDRIVES Motion Control

Power Factor	Magnetizing Current $I_{\mu}$	Rated Efficiency $\eta_{rated}$	Rated Frequency $f_{rated}$	Moment of inertia $J$	Weight, approx. kg (lb)	1PL6 Asynchronous Motors	SIMOVERT MASTERDRIVES MC	
						Order No.	Inverter/Converter Rated Current $I_{rated}$	Order No.
$\cos \varphi$	A		Hz	$\text{kgm}^2$ ( $\text{lb}_f\text{-in-s}^2$ )			A	
<b>Supply voltage 3-ph. AC 400 V for SIMOVERT MASTERDRIVES Motion Control</b>								
0.84	33.4	0.820	14.2	0.503 (4.4545)	370 (815.8)	1PL6 184 - . . B . . - 0 ■■■■	59	6SE7 026 - 0 ■ D51
0.84	48.6	0.828	14.1	0.666 (5.894)	440 (970.2)	1PL6 186 - . . B . . - 0 ■■■■	92	6SE7 031 - 0 ■ E50
0.86	45.8	0.864	14	1.479 (13.0889)	630 (1389.2)	1PL6 224 - . . B . . - 0 ■■■■	124	6SE7 031 - 2 ■ F50
0.85	67	0.868	14	1.930 (17.0802)	750 (1653.8)	1PL6 226 - . . B . . - 0 ■■■■	155	6SE7 031 - 8 ■ F50
0.86	77	0.871	14.1	2.326 (20.5848)	860 (1896.3)	1PL6 228 - . . B . . - 0 ■■■■	218	6SE7 032 - 6 ■ G50
0.87	45	0.897	34.4	0.503 (4.4545)	370 (815.8)	1PL6 184 - . . D . . - 0 ■■■■	124	6SE7 031 - 2 ■ F50
0.86	61	0.907	34.3	0.666 (5.894)	440 (970.2)	1PL6 186 - . . D . . - 0 ■■■■	155	6SE7 031 - 8 ■ E50
0.86	86	0.927	34.5	1.479 (13.0889)	630 (1389.2)	1PL6 224 - . . D . . - 0 ■■■■	218	6SE7 032 - 6 ■ G50
0.88	90	0.927	31.1	1.930 (17.0802)	750 (1653.8)	1PL6 226 - . . D . . - 0 ■■■■	308	6SE7 033 - 7 ■ G50
0.89	103	0.928	34.2	2.326 (20.5848)	860 (1896.3)	1PL6 228 - . . D . . - 0 ■■■■	423	6SE7 035 - 1 E K50
0.84	70	0.924	50.9	0.503 (4.4545)	370 (815.8)	1PL6 184 - . . F . . - 0 ■■■■	175	6SE7 032 - 1 ■ G50
0.85	91	0.930	50.9	0.666 (5.894)	460 (1014.3)	1PL6 186 - . . F . . - 0 ■■■■	262	6SE7 033 - 2 ■ G50
0.87	91	0.940	50.9	1.479 (13.0889)	640 (1411.2)	1PL6 224 - . . F . . - 0 ■■■■	308	6SE7 033 - 7 ■ G50
0.87	125	0.944	50.7	1.930 (17.0802)	760 (1675.8)	1PL6 226 - . . F . . - 0 ■■■■	423	6SE7 035 - 1 E K50
0.86	177	0.947	50.7	2.326 (20.5848)	870 (1918.4)	1PL6 228 - . . F . . - 0 ■■■■	491	6SE7 036 - 0 E K50
<ul style="list-style-type: none"> <li><b>Drive type:</b> <ul style="list-style-type: none"> <li>Coupling R</li> <li>Coupling R</li> <li>Coupling S</li> <li>Coupling SR</li> <li>Belt R</li> <li>Belt R</li> <li>Increased cantilever forces R</li> <li>Increased cantilever forces R</li> </ul> </li> <li><b>Vibration sev. grade:</b> <ul style="list-style-type: none"> <li>R</li> <li>R</li> <li>S</li> <li>SR</li> <li>R</li> <li>R</li> <li>R</li> </ul> </li> <li><b>Shaft and flange accuracy:</b> <ul style="list-style-type: none"> <li>N</li> <li>R</li> <li>R</li> <li>R</li> <li>N</li> <li>R</li> <li>N</li> <li>R</li> </ul> </li> </ul>						A B C D E F G H		
<ul style="list-style-type: none"> <li><b>Direction of air flow:</b> <ul style="list-style-type: none"> <li>DE → NDE</li> <li>NDE → DE<sup>5)</sup></li> <li>DE → NDE</li> <li>NDE → DE<sup>5)</sup></li> <li>DE → NDE</li> <li>NDE → DE<sup>5)</sup></li> </ul> </li> <li><b>Shaft end:</b> <ul style="list-style-type: none"> <li>With keyway, half-key balancing</li> <li>With keyway, half-key balancing</li> <li>With keyway, full-key balancing</li> <li>With keyway, full-key balancing</li> <li>Without keyway</li> <li>Without keyway</li> </ul> </li> </ul>						A B C D J K		
<ul style="list-style-type: none"> <li><b>Paint finish:</b> <ul style="list-style-type: none"> <li>Primed</li> <li>Anthracite gray, standard finish (RAL 7016)</li> <li>Anthracite gray, special finish (RAL 7016)</li> </ul> </li> </ul>						0 3 6		
<ul style="list-style-type: none"> <li><b>Special models:</b> <ul style="list-style-type: none"> <li>Please specify additional order code and any required plain text; see Page 3/45.</li> </ul> </li> </ul>						-Z		
<ul style="list-style-type: none"> <li>Converter</li> <li>Inverter</li> </ul>						E T		

- $n_1$ : Maximum permissible speed at constant power or speed where for  $P = P_{rated}$ , there is still a 30% power reserve up to the stall limit.
- $n_{S1}$ : Maximum permissible speed that is continuously permitted without speed duty cycles.
- $n_{max}$ : Maximum rotational speed. This speed may not be exceeded! Notice: Due to  $f_{max} < 2 \cdot f_{rated}$ , the maximum rotational speed is sometimes limited to smaller values.
- Rotational speed is reduced in the event of increased cantilever forces, see Part 7.
- Preferred air flow direction in contaminated environments.



# Servo Motors for SIMOVERT MASTERDRIVES

## Asynchronous Servo Motors

### 1PL6 Motors

#### Selection and Ordering Data with SIMOVERT MASTERDRIVES Motion Control (continued)

Rated Rotational Speed	Shaft Height	Rated Output	Rated Torque	Rated Current	Rated Voltage	Speed during Field Weakening <sup>1)</sup>	Max. Permissible Continuous Speed <sup>2)</sup>	Max. Speed <sup>3)</sup>	1PL6 Asynchronous Motors
$n_{rated}$		$P_{rated}$	$M_{rated}$	$I_{rated}$	$V_{rated}$	$n_1$	$n_{S1}$	$n_{max}$	Order No.
rpm	SH	kW (HP)	Nm (lb <sub>f</sub> -ft)	A	V	rpm	rpm	rpm	
<b>Supply voltage 3-ph. AC 400 V for SIMOVERT MASTERDRIVES Motion Control</b>									
<b>2500</b>	180	100 (134.05)	382 (281.8)	208	345	5000	3500 <sup>4)</sup>	5000	<b>1PL6 184</b> – ■ ■ L ■ ■ – 0 ...
		130 (174.26)	497 (366.6)	275	340	5000	3500 <sup>4)</sup>	5000	<b>1PL6 186</b> – ■ ■ L ■ ■ – 0 ...
	225	178 (238.61)	680 (501.6)	358	345	3500	3100 <sup>4)</sup>	4500	<b>1PL6 224</b> – ■ ■ L ■ ■ – 0 ...
		235 (315.01)	898 (662.4)	476	340	3500	3100 <sup>4)</sup>	4500	<b>1PL6 226</b> – ■ ■ L ■ ■ – 0 ...
		265 (355.23)	1013 (747.2)	535	345	3500	3100 <sup>4)</sup>	4500 <sup>4)</sup>	<b>1PL6 228</b> – ■ ■ L ■ ■ – 0 ...

**• Separate fan:**

- With separate fan
- Without separate fan, for pipe connection
- With separate fan, but with metric cable entries in accordance with EN 50262
- Without separate fan, for pipe connection, but with metric cable entries in accordance with EN 50262

4  
6  
7  
8

**• Encoder:**

- Absolute encoder EnDat 2,048 pulses/revolution
- Incremental encoder sin/cos 1  $V_{pp}$  (without C track or D track)
- Incremental encoder sin/cos 1  $V_{pp}$  (with C track and D track)
- Resolver, 2-pole

E  
N  
M  
R

**• Terminal box arrangement/direction of cable entry (drive-end view):**

- On top/from right
- On top/from drive end
- On top/from non-drive end
- On top/from left

0  
1  
2  
3

**• Construction type:**

- IM B3
  - IM B3
  - IM B35 (SH 180: With flange A 450, SH 225: With flange A 550)
  - IM B35 (SH 180: With flange A 450, SH 225: With flange A 550)
- Hoisting concept for other construction types (IM B6, IM B7, IM B8, IM V5, IM V6)
- Hoisting concept for other construction types (IM V15, IM V36)

0  
1  
3  
5

For order number supplements for drive type, direction of air flow, and paint finish (positions 14 through 16 of the order no.), see page 3/63.

# Servo Motors for SIMOVERT MASTERDRIVES

## Asynchronous Servo Motors

1PL6 Motors

### Selection and Ordering Data with SIMOVERT MASTERDRIVES Motion Control (continued)

Power Factor	Magnetizing Current $I_{\mu}$ A	Rated Efficiency $\eta_{rated}$	Rated Frequency $f_{rated}$ Hz	Moment of inertia $J$ kgm <sup>2</sup> (lb <sub>f</sub> -in-s <sup>2</sup> )	Weight, approx. kg (lb)	1PL6 Asynchronous Motors	SIMOVERT MASTERDRIVES MC	
						Order No.	Inverter/Converter Rated Current $I_{rated}$ A	Order No.
<b>Supply voltage 3-ph. AC 400 V for SIMOVERT MASTERDRIVES Motion Control</b>								
0.86	80	0.936	84.2	0.503 (4.4545)	390 (860)	1PL6 184 - . . L . . - 0 ■■■■	218	6SE7 032 - 6 ■ G50
0.85	113	0.943	84.1	0.666 (5.894)	470 (1036.4)	1PL6 186 - . . L . . - 0 ■■■■	308	6SE7 033 - 7 ■ G50
0.87	119	0.95	84.1	1.479 (13.0889)	640 (1411.2)	1PL6 224 - . . L . . - 0 ■■■■	423	6SE7 035 - 1 E K50
0.88	157	0.953	84	1.930 (17.0802)	760 (1675.8)	1PL6 226 - . . L . . - 0 ■■■■	491	6SE7 036 - 0 E K50
0.87	189	0.952	84	2.326 (20.5848)	870 (1918.4)	1PL6 228 - . . L . . - 0 ■■■■	491 <sup>5)</sup>	6SE7 036 - 0 E K50
<b>• Drive type:</b> Coupling R Coupling R Coupling S Coupling SR Belt R Belt R Increased cantilever forces R Increased cantilever forces R						<b>• Vibration sev. grade:</b> R R S R R R R		<b>• Shaft and flange accuracy:</b> N R R R N R N R
<b>• Direction of air flow:</b> DE → NDE NDE → DE <sup>6)</sup> DE → NDE NDE → DE <sup>6)</sup> DE → NDE NDE → DE <sup>6)</sup>						<b>• Shaft end:</b> With keyway, half-key balancing With keyway, half-key balancing With keyway, full-key balancing With keyway, full-key balancing Without keyway Without keyway		A B C D E F G H  A B C D J K
<b>• Paint finish:</b> Primed Anthracite gray, standard finish (RAL 7016) Anthracite gray, special finish (RAL 7016)						0 3 6		
<b>• Special models:</b> Please specify additional order code and any required plain text; see Page 3/45.						-Z		
Converter Inverter								E T

3

1)  $n_1$ : Maximum permissible speed at constant power or speed where for  $P = P_{rated}$ , there is still a 30% power reserve up to the stall limit.  
 2)  $n_{S1}$ : Maximum permissible speed that is continuously permitted without speed duty cycles.  
 3)  $n_{max}$ : Maximum rotational speed. This speed may not be exceeded! Notice: Due to  $f_{max} < 2 \cdot f_{rated}$ , the maximum rotational speed is sometimes limited to smaller values.

4) Rotational speed is reduced in the event of increased cantilever forces, see Part 7.  
 5) Notice: The rated converter current is smaller than the rated motor current.  
 6) Preferred air flow direction in contaminated environments.

# Servo Motors for SIMOVERT MASTERDRIVES

## Asynchronous Servo Motors

### 1PL6 Motors

#### Selection and Ordering Data with SIMOVERT MASTERDRIVES Motion Control

Rated Rotational Speed	Shaft Height	Rated Output	Rated Torque	Rated Current	Rated Voltage	Speed during Field Weakening <sup>1)</sup>	Max. Permissible Continuous Speed <sup>2)</sup>	Max. Speed <sup>3)</sup>	1PL6 Asynchronous Motors
$n_{rated}$	SH	$P_{rated}$	$M_{rated}$	$I_{rated}$	$V_{rated}$	$n_1$	$n_{S1}$	$n_{max}$	Order No.
rpm		kW (HP)	Nm (lb <sub>f</sub> -ft)	A	V	rpm	rpm	rpm	
<b>Supply voltage 3-ph. AC 480 V for SIMOVERT MASTERDRIVES Motion Control</b>									
<b>400</b>	180	24.5 (32.84)	585 (431.5)	69	300	800	800	800	<b>1PL6 184 - ■ ■ B ■ ■ - 0 . . .</b>
		31.5 (42.23)	752 (554.7)	90	290	800	800	800	<b>1PL6 186 - ■ ■ B ■ ■ - 0 . . .</b>
	225	45 (60.32)	1074 (792.2)	117	300	800	800	800	<b>1PL6 224 - ■ ■ B ■ ■ - 0 . . .</b>
		57 (76.41)	1361 (1003.9)	145	305	800	800	800	<b>1PL6 226 - ■ ■ B ■ ■ - 0 . . .</b>
		72 (96.51)	1719 (1267.9)	181	305	800	800	800	<b>1PL6 228 - ■ ■ B ■ ■ - 0 . . .</b>
<b>1150</b>	180	65 (87.13)	540 (398.3)	121	400	1750	2300	2300	<b>1PL6 184 - ■ ■ D ■ ■ - 0 . . .</b>
		85 (113.94)	706 (520.7)	158	400	1950	2300	2300	<b>1PL6 186 - ■ ■ D ■ ■ - 0 . . .</b>
	225	120 (160.86)	997 (735.4)	218	400	2100	2300	2300	<b>1PL6 224 - ■ ■ D ■ ■ - 0 . . .</b>
		155 (207.77)	1287 (949.3)	275	400	2000	2300	2300	<b>1PL6 226 - ■ ■ D ■ ■ - 0 . . .</b>
		190 (254.69)	1578 (1163.9)	334	400	1850	2300	2300	<b>1PL6 228 - ■ ■ D ■ ■ - 0 . . .</b>

**• Separate fan:**

- With separate fan
- Without separate fan, for pipe connection
- With separate fan, but with metric cable entries in accordance with EN 50262
- Without separate fan, for pipe connection, but with metric cable entries in accordance with EN 50262

4  
6  
7  
8

**• Encoder:**

- Absolute encoder EnDat 2,048 pulses/revolution
- Incremental encoder sin/cos 1  $V_{pp}$  (without C track or D track)
- Incremental encoder sin/cos 1  $V_{pp}$  (with C track and D track)
- Resolver, 2-pole

E  
N  
M  
R

**• Terminal box arrangement/direction of cable entry (drive-end view):**

- On top/from right
- On top/from drive end
- On top/from non-drive end
- On top/from left

0  
1  
2  
3

**• Construction type:**

- IM B3
  - IM B3
  - IM B35 (SH 180: With flange A 450, SH 225: With flange A 550)
  - IM B35 (SH 180: With flange A 450, SH 225: With flange A 550)
- Hoisting concept for other construction types (IM B6, IM B7, IM B8, IM V5, IM V6)
- Hoisting concept for other construction types (IM V15, IM V36)

0  
1  
3  
5

For order number supplements for drive type, direction of air flow, and paint finish (positions 14 through 16 of the order no.), see page 3/65.

# Servo Motors for SIMOVERT MASTERDRIVES

## Asynchronous Servo Motors

1PL6 Motors

### Selection and Ordering Data with SIMOVERT MASTERDRIVES Motion Control

Power Factor	Magnetizing Current $I_{\mu}$ A	Rated Efficiency $\eta_{rated}$	Rated Frequency $f_{rated}$ Hz	Moment of inertia $J$ kgm <sup>2</sup> (lb <sub>f</sub> -in-s <sup>2</sup> )	Weight, approx. kg (lb)	1PL6 Asynchronous Motors	SIMOVERT MASTERDRIVES MC Inverter/Converter Rated Current	
						Order No.	$I_{rated}$ A	Order No.
<b>Supply voltage 3-ph. AC 480 V for SIMOVERT MASTERDRIVES Motion Control</b>								
0.86	33	0.80	14.4	0.503 (4.4545)	370 (815.8)	1PL6 184 - . . B . . - 0 ■ ■ ■ ■	72	6SE7 027 - 2 ■ D51
0.85	47	0.814	14.3	0.666 (5.894)	440 (970.2)	1PL6 186 - . . B . . - 0 ■ ■ ■ ■	92	6SE7 031 - 0 ■ E50
0.87	45	0.844	14.2	1.479 (13.0889)	630 (1389.2)	1PL6 224 - . . B . . - 0 ■ ■ ■ ■	124	6SE7 031 - 2 ■ F50
0.85	67	0.868	14.0	1.930 (17.0802)	750 (1653.8)	1PL6 226 - . . B . . - 0 ■ ■ ■ ■	155	6SE7 031 - 8 ■ F50
0.86	77	0.871	14.0	2.326 (20.5848)	860 (1896.3)	1PL6 228 - . . B . . - 0 ■ ■ ■ ■	175	6SE7 032 - 1 ■ G50
0.86	46	0.906	39.4	0.503 (4.4545)	370 (815.8)	1PL6 184 - . . D . . - 0 ■ ■ ■ ■	124	6SE7 031 - 2 ■ F50
0.86	62	0.910	39.4	0.666 (5.894)	440 (970.2)	1PL6 186 - . . D . . - 0 ■ ■ ■ ■	155	6SE7 031 - 8 ■ F50
0.86	86	0.930	39.1	1.479 (13.0889)	630 (1389.2)	1PL6 224 - . . D . . - 0 ■ ■ ■ ■	218	6SE7 032 - 6 ■ G50
0.87	92	0.930	39.2	1.930 (17.0802)	750 (1653.8)	1PL6 226 - . . D . . - 0 ■ ■ ■ ■	308	6SE7 033 - 7 ■ G50
0.88	102	0.931	39.2	2.326 (20.5848)	860 (1896.3)	1PL6 228 - . . D . . - 0 ■ ■ ■ ■	423	6SE7 035 - 1 E K50

<ul style="list-style-type: none"> <li><b>Drive type:</b></li> <li>Coupling R</li> <li>Coupling R</li> <li>Coupling S</li> <li>Coupling SR</li> <li>Belt R</li> <li>Belt R</li> <li>Increased cantilever forces R</li> <li>Increased cantilever forces R</li> </ul>	<ul style="list-style-type: none"> <li><b>Vibration sev. grade:</b></li> <li>R</li> <li>R</li> <li>R</li> <li>R</li> <li>N</li> <li>R</li> <li>N</li> <li>R</li> </ul>	<ul style="list-style-type: none"> <li><b>Shaft and flange accuracy:</b></li> <li>N</li> <li>R</li> <li>R</li> <li>R</li> <li>N</li> <li>R</li> <li>N</li> <li>R</li> </ul>
---	--	---

A  
B  
C  
D  
E  
F  
G  
H

<ul style="list-style-type: none"> <li><b>Direction of air flow:</b></li> <li>DE → NDE</li> <li>NDE → DE<sup>4</sup>)</li> <li>DE → NDE</li> <li>NDE → DE<sup>4</sup>)</li> <li>DE → NDE</li> <li>NDE → DE<sup>4</sup>)</li> </ul>	<ul style="list-style-type: none"> <li><b>Shaft end:</b></li> <li>With keyway, half-key balancing</li> <li>With keyway, half-key balancing</li> <li>With keyway, full-key balancing</li> <li>With keyway, full-key balancing</li> <li>Without keyway</li> <li>Without keyway</li> </ul>
--	---

A  
B  
C  
D  
J  
K

<ul style="list-style-type: none"> <li><b>Paint finish:</b></li> <li>Primed</li> <li>Anthracite gray, standard finish (RAL 7016)</li> <li>Anthracite gray, special finish (RAL 7016)</li> </ul>
---

0  
3  
6

<ul style="list-style-type: none"> <li><b>Special models:</b></li> <li>Please specify additional order code and any required plain text; see Page 3/45.</li> </ul>
--

-Z

<ul style="list-style-type: none"> <li>Converter</li> <li>Inverter</li> </ul>	E T
---	--------

3

1)  $n_1$ : Maximum permissible speed at constant power or speed where for  $P = P_{rated}$ , there is still a 30% power reserve up to the stall limit.  
 2)  $n_{S1}$ : Maximum permissible speed that is continuously permitted without speed duty cycles.  
 3)  $n_{max}$ : Maximum rotational speed. This speed may not be exceeded! Notice: Due to  $f_{max} < 2 \cdot f_{rated}$ , the maximum rotational speed is sometimes limited to smaller values.  
 4) Preferred air flow direction in contaminated environments.

# Servo Motors for SIMOVERT MASTERDRIVES

## Asynchronous Servo Motors

### 1PL6 Motors

#### Selection and Ordering Data with SIMOVERT MASTERDRIVES Motion Control (continued)

Rated Rotational Speed	Shaft Height	Rated Output	Rated Torque	Rated Current	Rated Voltage	Speed during Field Weakening <sup>1)</sup>	Max. Permissible Continuous Speed <sup>2)</sup>	Max. Speed <sup>3)</sup>	1PL6 Asynchronous Motors
$n_{rated}$		$P_{rated}$	$M_{rated}$	$I_{rated}$	$V_{rated}$	$n_1$	$n_{S1}$	$n_{max}$	Order No.
rpm	SH	kW (HP)	Nm (lb <sub>f</sub> -ft)	A	V	rpm	rpm	rpm	
<b>Supply voltage 3-ph. AC 480 V for SIMOVERT MASTERDRIVES Motion Control</b>									
1750	180	89 (119.3)	486 (358.5)	166	400	3500	3500 <sup>4)</sup>	3500	1PL6 184 - ■ ■ F ■ ■ - 0 . . .
		125 (167.56)	682 (503)	231	400	3400	3500 <sup>4)</sup>	3500	1PL6 186 - ■ ■ F ■ ■ - 0 . . .
	225	165 (221.18)	900 (663.8)	292	400	3000	3100 <sup>4)</sup>	3500	1PL6 224 - ■ ■ F ■ ■ - 0 . . .
		200 (268.1)	1091 (804.7)	350	400	2900	3100 <sup>4)</sup>	3500	1PL6 226 - ■ ■ F ■ ■ - 0 . . .
		265 (355.23)	1446 (1066.6)	470	400	2900	3100 <sup>4)</sup>	3500	1PL6 228 - ■ ■ F ■ ■ - 0 . . .
2900	180	113 (151.47)	372 (274.4)	209	400	5000	3500 <sup>4)</sup>	5000	1PL6 184 - ■ ■ L ■ ■ - 0 . . .
		150 (201.07)	494 (364.4)	280	390	5000	3500 <sup>4)</sup>	5000	1PL6 186 - ■ ■ L ■ ■ - 0 . . .
	225	205 (274.8)	675 (497.9)	365	400	3500	3100 <sup>4)</sup>	4500	1PL6 224 - ■ ■ L ■ ■ - 0 . . .
		270 (361.93)	889 (655.7)	470	400	3500	3100 <sup>4)</sup>	4500	1PL6 226 - ■ ■ L ■ ■ - 0 . . .
		300 (402.14)	988 (728.7)	530	400	3500	3100 <sup>4)</sup>	4500 <sup>4)</sup>	1PL6 228 - ■ ■ L ■ ■ - 0 . . .

#### • Separate fan:

- With separate fan
- Without separate fan, for pipe connection
- With separate fan, but with metric cable entries in accordance with EN 50262
- Without separate fan, for pipe connection, but with metric cable entries in accordance with EN 50262

4  
6  
7  
8

#### • Encoder:

- Absolute encoder EnDat 2,048 pulses/revolution
- Incremental encoder sin/cos 1  $V_{pp}$  (without C track or D track)
- Incremental encoder sin/cos 1  $V_{pp}$  (with C track and D track)
- Resolver, 2-pole

E  
N  
M  
R

#### • Terminal box arrangement/direction of cable entry (drive-end view):

- On top/from right
- On top/from drive end
- On top/from non-drive end
- On top/from left

0  
1  
2  
3

#### • Construction type:

- IM B3
  - IM B3
  - IM B35 (SH 180: With flange A 450, SH 225: With flange A 550)
  - IM B35 (SH 180: With flange A 450, SH 225: With flange A 550)
- Hoisting concept for other construction types (IM B6, IM B7, IM B8, IM V5, IM V6)
- Hoisting concept for other construction types (IM V15, IM V36)

0  
1  
3  
5

For order number supplements for drive type, direction of air flow, and paint finish (positions 14 through 16 of the order no.), see page 3/67.

# Servo Motors for SIMOVERT MASTERDRIVES

## Asynchronous Servo Motors

1PL6 Motors

### Selection and Ordering Data with SIMOVERT MASTERDRIVES Motion Control (continued)

Power Factor	Magnetizing Current $I_{\mu}$ A	Rated Efficiency $\eta_{rated}$	Rated Frequency $f_{rated}$ Hz	Moment of inertia $J$ kgm <sup>2</sup> (lb <sub>f</sub> -in-s <sup>2</sup> )	Weight, approx. kg (lb)	1PL6 Asynchronous Motors	SIMOVERT MASTERDRIVES MC Inverter/Converter Rated Current	
						Order No.	$I_{rated}$ A	Order No.
<b>Supply voltage 3-ph. AC 480 V for SIMOVERT MASTERDRIVES Motion Control</b>								
0.84	68	0.921	59.3	0.503 (4.4545)	370 (815.8)	1PL6 184 - . . . F . . . 0 ■■■■	175	6SE7 032 - 1 ■ G50
0.84	92	0.935	59.3	0.666 (5.894)	440 (970.2)	1PL6 186 - . . . F . . . 0 ■■■■	262	6SE7 033 - 2 ■ G50
0.87	90	0.942	59.2	1.479 (13.0889)	630 (1389.2)	1PL6 224 - . . . F . . . 0 ■■■■	308	6SE7 033 - 7 ■ G50
0.87	122	0.945	59.1	1.930 (17.0802)	750 (1653.8)	1PL6 226 - . . . F . . . 0 ■■■■	423	6SE7 035 - 1 E K50
0.86	174	0.948	59.0	2.326 (20.5848)	860 (1896.3)	1PL6 228 - . . . F . . . 0 ■■■■	491	6SE7 036 - 0 E K50
0.85	79	0.938	97.6	0.503 (4.4545)	370 (815.8)	1PL6 184 - . . . L . . . 0 ■■■■	218	6SE7 032 - 6 ■ G50
0.84	110	0.943	97.5	0.666 (5.894)	440 (970.2)	1PL6 186 - . . . L . . . 0 ■■■■	308	6SE7 033 - 7 ■ G50
0.86	118	0.950	97.5	1.479 (13.0889)	630 (1389.2)	1PL6 224 - . . . L . . . 0 ■■■■	423	6SE7 035 - 1 K U50
0.87	160	0.952	97.4	1.930 (17.0802)	750 (1653.8)	1PL6 226 - . . . L . . . 0 ■■■■	491	6SE7 036 - 0 K U50
0.86	188	0.952	97.3	2.326 (20.5848)	860 (1896.3)	1PL6 228 - . . . L . . . 0 ■■■■	491 <sup>5)</sup>	6SE7 036 - 0 E K50
<ul style="list-style-type: none"> <li><b>Drive type:</b> <ul style="list-style-type: none"> <li>Coupling R</li> <li>Coupling R</li> <li>Coupling S</li> <li>Coupling SR</li> <li>Belt R</li> <li>Belt R</li> <li>Increased cantilever forces R</li> <li>Increased cantilever forces R</li> </ul> </li> <li><b>Vibration sev. grade:</b> <ul style="list-style-type: none"> <li>R</li> <li>R</li> <li>R</li> <li>R</li> <li>N</li> <li>R</li> <li>N</li> <li>R</li> </ul> </li> <li><b>Shaft and flange accuracy:</b> <ul style="list-style-type: none"> <li>N</li> <li>R</li> <li>R</li> <li>R</li> <li>N</li> <li>R</li> <li>N</li> <li>R</li> </ul> </li> </ul>						A B C D E F G H		
<ul style="list-style-type: none"> <li><b>Direction of air flow:</b> <ul style="list-style-type: none"> <li>DE → NDE</li> <li>NDE → DE<sup>6)</sup></li> <li>DE → NDE</li> <li>NDE → DE<sup>6)</sup></li> <li>DE → NDE</li> <li>NDE → DE<sup>6)</sup></li> </ul> </li> <li><b>Shaft end:</b> <ul style="list-style-type: none"> <li>With keyway, half-key balancing</li> <li>With keyway, half-key balancing</li> <li>With keyway, full-key balancing</li> <li>With keyway, full-key balancing</li> <li>Without keyway</li> <li>Without keyway</li> </ul> </li> </ul>						A B C D J K		
<ul style="list-style-type: none"> <li><b>Paint finish:</b> <ul style="list-style-type: none"> <li>Primed</li> <li>Anthracite gray, standard finish (RAL 7016)</li> <li>Anthracite gray, special finish (RAL 7016)</li> </ul> </li> </ul>						0 3 6		
<ul style="list-style-type: none"> <li><b>Special models:</b> <ul style="list-style-type: none"> <li>Please specify additional order code and any required plain text; see Page 3/45.</li> </ul> </li> </ul>						-Z		
<ul style="list-style-type: none"> <li>Converter</li> <li>Inverter</li> </ul>						E T		

- $n_1$ : Maximum permissible speed at constant power or speed where for  $P = P_{rated}$ , there is still a 30% power reserve up to the stall limit.
- $n_{S1}$ : Maximum permissible speed that is continuously permitted without speed duty cycles.
- $n_{max}$ : Maximum rotational speed. This speed may not be exceeded! Notice: Due to  $f_{max} < 2 \cdot f_{rated}$ , the maximum rotational speed is sometimes limited to smaller values.
- Rotational speed is reduced in the event of increased cantilever forces, see Part 7.
- Notice: The rated converter current is smaller than the rated motor current.
- Preferred air flow direction in contaminated environments.

# Servo Motors for SIMOVERT MASTERDRIVES

## Asynchronous Servo Motors

### 1PL6 Motors, Shaft Height 280

#### Selection and Ordering Data

##### Permissible Combinations of Mechanical Models

**1PL6 28 . Motors**  
**Shaft Height 280**

Position in  
Order No. 8 9 10 11 12 13 14 15 16  
**1PL6 28 . -** ■ . . . ■ ■ . . . ■ . . .

##### Permissible Combinations of Mechanical Models

**Separately driven fan**  
8th Position in Order No.  
**1PL6 28 . -** ■ . . . . .

##### Order No. Supplement

0	1	2	3	4	5	6
NDE <b>Top</b> Non- Drive End --> Drive End	NDE <b>Right</b> Non- Drive End --> Drive End	NDE <b>Left</b> Non- Drive End --> Drive End	Drive End <b>Top</b> Drive End --> Non- Drive End	Drive End <b>Right</b> Drive End --> Non- Drive End	Drive End <b>Left</b> Drive End --> Non- Drive End	<b>Simple Pipe Connection Non-Drive End Right</b> (Can Be Converted to NDE Left)

**1PL6 28 . - . . . . 0 - . . . .** Type of construction IM B3

**1PL6 28 . - . . . . 1 - . . . .** Type IM V5  
(Can be converted later to  
IM V6)

**1PL6 28 . - . . . . 3 - . . . .** Type of construction IM B35

**1PL6 28 . - . . . . 5 - . . . .** Type IM V15  
(Can be converted later to  
IM V36)

##### Option codes

- R1Y** Standard finish RAL ...
- R2Y** Special finish RAL ...
- G14** With air filter
- K08** Encoder connector attachment, facing
- K55** Customer-specific entry plate for terminal box<sup>1)</sup>
- K83** Terminal box rotation by + 90 degrees (from standard position)
- K84** Terminal box rotation by - 90 degrees (from standard position)
- K85** Terminal box rotation by 180 degrees (from standard position)
- K16** Additional normal shaft end (only available with no encoder)
- K31** Additional rating plate
- K45** 230 V standstill heating
- C30** 690 V model
- Y55** Atypical shaft end, drive side
- Y80** Different rating plate data<sup>1)</sup>
- Y82** Additional plate with customer information<sup>1)</sup>
- M83** Additional pulling thread on motor feet

Standard Model
Approved Supplemental Types

1) Plain text required







# Servo Motors for SIMOVERT MASTERDRIVES

## Asynchronous Servo Motors

### 1PH4 Motors Water Cooling

#### Overview

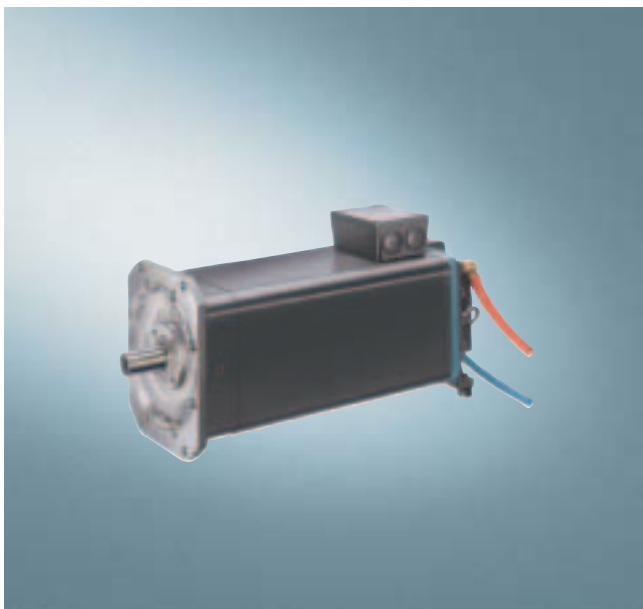

1PH4 AC Motors, Shaft Height 100 to 160

The AC motors in the 1PH4 series are compact, water-cooled asynchronous motors with a squirrel cage rotor with a high degree of protection.

These motors were developed especially for operation on the SIMOVERT MASTERDRIVES Vector Control and Motion Control drive system. In this way, power losses and noise levels have been reduced to a minimum. Depending on the control requirements, appropriate encoder systems for measuring motor speed and indirect positions are available for these motors.

#### Uses/Benefits

- High power density with small motor dimensions
- High degree of protection (IP65; IP55 for shaft exit)
- Speed to zero without torque reduction
- Low noise level
- High transverse load capability
- Robustness
- Very little maintenance required
- High rotational accuracy
- Integrated encoder system for measuring motor speed, connected via connectors
- Terminal boxes for connecting power cables
- KTY 84 monitoring of motor temperature
- Maximum permissible water pressure, 6 bar

#### Application

- All applications in which extreme environmental conditions such as dust, dirt, or a corrosive atmosphere do not allow for air cooling
- Processes in which the environment cannot withstand thermal stress.
- Special machines when cooling water is an inherent process element.

# Servo Motors for SIMOVERT MASTERDRIVES

## Asynchronous Servo Motors

1PH4 Motors  
Water Cooling

### Technical Data

Insulation of the stator winding in accordance with EN 60034-1 (IEC 60034-1)	Temperature class F for a coolant inlet temperature up to +30 °C (+86 °F)
Construction type in acc. with EN 60034-7 (IEC 60034-7)	IM B35 (IM V15, IM V36)
Degrees of protect. in acc. with EN 60034-5 (IEC 60034-5)	IP65, (IP55 on shaft exit)
Cooling in accordance with EN 60034-6 (IEC 60034-6)	Water cooling Due to the possible formation of water condensation, we recommend a coolant inlet temperature of approx. +30 °C (+86 °F), depending on the environmental conditions. Max. cooling water pressure at inlet: 6 bar Quantity of cooling water/connecting thread non-drive end: 1PH4 10: 6 l/min/G $1/4$ 7) 1PH4 13: 8 l/min/G $3/8$ 7) 1PH4 16: 10 l/min/G $1/2$ 7)
Temperature monitoring	KTY 84 temperature sensor in stator winding
Paint finish	Anthracite gray RAL 7016
Shaft end on the DE in acc. with DIN 748-3 (IEC 60072-1)	With keyway, full-key balancing
Shaft and flange accuracy in accordance with DIN 42955 (IEC 60072-1)	Tolerance N (normal)
Vibration severity grade in accordance with EN 60034-14 (IEC 60034-14)	Grade R (reduced)
Sound press. level acc. to EN 1680 Tolerance +3 dB	1PH4 10: 69 dB (A) 1PH4 13: 69 dB (A) 1PH4 16: 71 dB (A)
Bearing designs	Duplex bearings on DE for belt drive (minimum cantilever force required)
Encoder system, integrated	– Incremental encoder HTL 1,024 or 2,048 pulses/revolution – Incremental encoder sin/cos 1 V <sub>pp</sub> , 2,048 pulses/revolution – Absolute encoder EnDat 2,048 pulses/revolution
Connection	Connector for signals (mating connector not included) Terminal box for power; Terminal box on top (Can be rotated 4 x 90°)

### Options

See Selection and Ordering Data and Options table on this page

### Characteristics

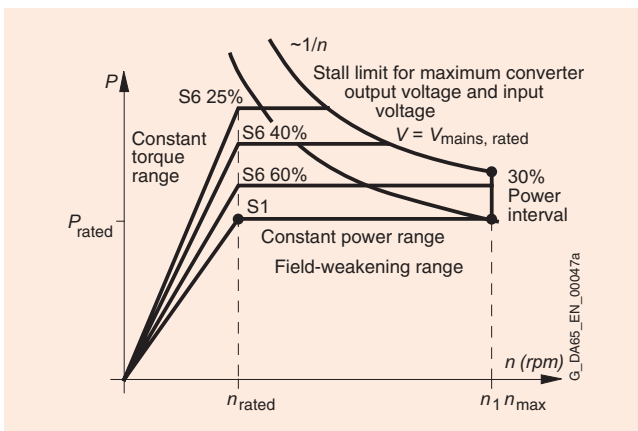

Power-Speed Curve

### Options

Code	Description
<b>K00</b>	<b>Bearing design</b> (drive end view) (Standard = duplex bearing) – Single bearing for coupling, planetary gear units or low to moderate cantilever forces
<b>K05</b> <sup>2)</sup> <b>K02</b> <sup>2)</sup> <b>K03</b> <sup>2)</sup>	<b>Vibration severity</b> in accordance with EN 60034-14 (IEC 60034-14) (Standard = vibration severity grade R, duplex bearing) – Grade S with duplex bearing arrangement <sup>1)</sup> – Grade S with single bearing arrangement <sup>1)</sup> – Grade SR with single bearing arrangement <sup>1)</sup>
<b>K04</b> <sup>3)</sup>	<b>Shaft and flange accuracy</b> in accordance with DIN 42955 (IEC 60072-1) (Standard = tolerance N) – Tolerance R
<b>K42</b> <b>L69</b>	<b>Shaft end (on drive end)</b> (Standard = full-key balancing with keyway) – Keyless shaft – Half-key balancing
<b>K18</b> <sup>4)</sup>	<b>Shaft seal (drive end)</b> – Rotary shaft seal, oil-tight, IP65
<b>K00</b>	<b>Gearbox</b> <sup>1)5)</sup> – Motor is prepared for attachment of ZF gear-change gearbox 2LG43... (IM B35 or IM V15) For information about gearbox attachment, see Part 4
<b>G46</b>	<b>Brake</b> <sup>1)</sup> – With holding brake mounted on drive end
<b>K09</b> <b>K10</b>	<b>Terminal box arrangement</b> (Drive end view) (standard = top) – Right-hand side <sup>1)</sup> – Left-hand side <sup>1)</sup> Rotation of terminal box on its own axis
<b>K83</b> <b>K84</b> <b>K85</b>	– 90°, cable entry from drive end <sup>1)</sup> – 90°, cable entry from non-drive end <sup>1)</sup> – 180° <sup>1)</sup>
<b>L37</b>	<b>Speed</b> <sup>1)6)</sup> – with increased speed 1PH4 10: 12000 rpm 1PH4 13: 10000 rpm 1PH4 16: 8000 rpm (No ZF gearbox attachment)
<b>K31</b>	<b>Others</b> – Second rating plate, separately packed
<b>H30</b>	<b>Encoder system</b> – Without encoder

- Options mutually exclude one another.
- Automatically includes version K04.
- Increased shaft accuracy.
- Only useful if oil spray/mist occasionally lubricate the sealing ring.
- Vibration severity grades S and SR not possible with attached gearbox. Use code K00 + G97 for old ZF gearbox 2LG42..., see Part 4 for gearbox selection
- Version for increased maximum speed contains vibration severity SR. The following options are not possible:
  - Prepared for ZF gearbox attachment
  - Shaft seal
- 6 l = 1.32 British gallons/1.58 US gallons  
8 l = 1.76 British gallons/2.11 US gallons  
10 l = 2.2 British gallons/2.64 US gallons

# Servo Motors for SIMOVERT MASTERDRIVES

## Asynchronous Servo Motors

### 1PH4 Motors Water Cooling

#### Selection and Ordering Data with SIMOVERT MASTERDRIVES Vector Control<sup>1)</sup>

Rated Rotational Speed	Shaft Height	Rated Output	Rated Torque	Rated Current	Rated Voltage	Speed during Field Weakening <sup>2)</sup>	Max. Permissible Continuous Speed <sup>3)</sup>	Max. Speed <sup>4)</sup>	1PH4 Asynchronous Motors
$n_{rated}$	SH	$P_{rated}$	$M_{rated}$	$I_{rated}$	$V_{rated}$	$n_1$	$n_{S1}$	$n_{max}$	Order No.
rpm		kW (HP)	Nm (lb <sub>f</sub> -ft)	A	V	rpm	rpm	rpm	
<b>Supply voltage 3-ph. AC 400 V for SIMOVERT MASTERDRIVES Vector Control</b>									
<b>1750</b>	100	8.8 (11.8)	48 (35.4)	20.5	400	2800	5600	8750	<b>1PH4 103 – 4 ■ F56</b>
		12.8 (17.26)	70 (51.6)	28	400	2600	5600	8750	<b>1PH4 105 – 4 ■ F56</b>
		16.3 (21.85)	89 (65.6)	35.5	400	2800	5600	8750	<b>1PH4 107 – 4 ■ F56</b>
	132	17.5 (23.46)	96 (70.8)	35.5	400	2100	5200	8000	<b>1PH4 133 – 4 ■ F56</b>
		25.5 (34.18)	139 (102.5)	52	400	2500	5200	8000	<b>1PH4 135 – 4 ■ F56</b>
		31.5 (42.26)	172 (126.9)	63	400	2300	5200	8000	<b>1PH4 137 – 4 ■ F56</b>
	160	43 (57.64)	235 (173.3)	88	400	2800	4000	6500	<b>1PH4 163 – 4 ■ F56</b>
		54 (72.39)	295 (217.6)	107	400	2600	4000	6500	<b>1PH4 167 – 4 ■ F56</b>
		61 (81.8)	333 (245.6)	117	400	2400	4000	6500	<b>1PH4 168 – 4 ■ F56</b>
<b>Supply voltage 3-ph. AC 480 V for SIMOVERT MASTERDRIVES Vector Control</b>									
<b>2000</b>	100	9.5 (12.73)	45 (33.2)	19.5	450	3300	5600	9000	<b>1PH4 103 – 4 ■ F56</b>
		14 (18.77)	67 (49.4)	26.5	450	3000	5600	9000	<b>1PH4 105 – 4 ■ F56</b>
		18 (24.13)	86 (63.4)	34.5	450	3200	5600	9000	<b>1PH4 107 – 4 ■ F56</b>
	132	19 (25.47)	91 (67.1)	33.5	450	2400	5200	8000	<b>1PH4 133 – 4 ■ F56</b>
		28 (37.53)	134 (98.8)	50	450	2700	5200	8000	<b>1PH4 135 – 4 ■ F56</b>
		34 (45.58)	162 (119.5)	59	450	2600	5200	8000	<b>1PH4 137 – 4 ■ F56</b>
	160	47 (63)	224 (165.2)	84	450	3000	4000	6500	<b>1PH4 163 – 4 ■ F56</b>
		58 (77.75)	277 (204.3)	101	450	3000	4000	6500	<b>1PH4 167 – 4 ■ F56</b>
		65 (87.13)	310 (228.7)	110	450	2800	4000	6500	<b>1PH4 168 – 4 ■ F56</b>

• Encoder:

Incremental encoder HTL 1,024 pulses/revolution  
Incremental encoder HTL 2,048 pulses/revolution

H  
J

# Servo Motors for SIMOVERT MASTERDRIVES

## Asynchronous Servo Motors

1PH4 Motors  
Water Cooling

### Selection and Ordering Data with SIMOVERT MASTERDRIVES Vector Control<sup>1)</sup>

Power Factor $\cos \varphi$	Magnetizing Current $I_{\mu}$ A	Rated Efficiency $\eta_{rated}$	Rated Frequency $f_{rated}$ Hz	Moment of inertia $J$ kgm <sup>2</sup> (lb <sub>f</sub> -in-s <sup>2</sup> )	Weight, approx. kg (lb)	1PH4 Asynchronous Motors Order No.	SIMOVERT MASTERDRIVES VC Inverter/Converter Rated Current $I_{rated}$ A	Order No.
	<b>Supply voltage 3-ph. AC 400 V for SIMOVERT MASTERDRIVES Vector Control</b>							
0.75	11.5	0.841	61.2	0.017 (0.1504)	52 (114.7)	1PH4 103 -4 . F56	20.5	6SE7 022 - 1 E P60
0.78	13.5	0.854	61.3	0.024 (0.2124)	67 (147.7)	1PH4 105 -4 . F56	34	6SE7 023 - 4 P60
0.78	18	0.867	61.0	0.031 (0.2743)	80 (176.4)	1PH4 107 -4 . F56	37.5	6SE7 023 - 8 D61
0.82	12	0.887	60.2	0.046 (0.4071)	90 (198.5)	1PH4 133 -4 . F56	37.5	6SE7 023 - 8 D61
0.79	22	0.901	59.8	0.071 (0.6283)	112 (247)	1PH4 135 -4 . F56	59	6SE7 026 - 0 D61
0.81	23	0.905	59.9	0.085 (0.7522)	130 (286.7)	1PH4 137 -4 . F56	72	6SE7 027 - 2 D61
0.78	42	0.914	59.3	0.170 (1.5045)	175 (385.9)	1PH4 163 -4 . F56	92	6SE7 031 - 0 E60
0.80	44	0.920	59.4	0.206 (1.8231)	210 (463.1)	1PH4 167 -4 . F56	124	6SE7 031 - 2 F60
0.82	43	0.921	59.4	0.220 (1.947)	240 (529.2)	1PH4 168 -4 . F56	124	6SE7 031 - 2 F60
<b>Supply voltage 3-ph. AC 480 V for SIMOVERT MASTERDRIVES Vector Control</b>								
0.74	11.2	0.856	69.3	0.017 (0.1504)	52 (114.7)	1PH4 103 -4 . F56	20.5	6SE7 022 - 1 E P60
0.79	12.9	0.870	69.4	0.024 (0.2124)	67 (147.7)	1PH4 105 -4 . F56	34	6SE7 023 - 4 P60
0.78	17.1	0.879	69.1	0.031 (0.2743)	80 (176.4)	1PH4 107 -4 . F56	37.5	6SE7 023 - 8 D61
0.83	11.9	0.899	68.4	0.046 (0.4071)	90 (198.5)	1PH4 133 -4 . F56	37.5	6SE7 023 - 8 D61
0.80	21.5	0.909	68.1	0.071 (0.6283)	112 (247)	1PH4 135 -4 . F56	59	6SE7 026 - 0 D61
0.83	22.1	0.914	68.1	0.085 (0.7522)	130 (286.7)	1PH4 137 -4 . F56	72	6SE7 027 - 2 D61
0.79	39.7	0.923	67.6	0.170 (1.5045)	175 (385.9)	1PH4 163 -4 . F56	92	6SE7 031 - 0 E60
0.81	42.6	0.926	67.6	0.206 (1.8231)	210 (463.1)	1PH4 167 -4 . F56	124	6SE7 031 - 2 F60
0.83	41.0	0.928	67.6	0.220 (1.947)	240 (529.2)	1PH4 168 -4 . F56	124	6SE7 031 - 2 F60
Converter Inverter							E T	

1) For rated currents < 37.5 A, Compact PLUS devices are assigned.  
 2)  $n_1$ : Maximum permissible speed at constant power or speed where for  $P = P_{rated}$ , there is still a 30% power reserve up to the stall limit.  
 3)  $n_{S1}$ : Maximum permissible speed that is continuously permitted without speed duty cycles.

4)  $n_{max}$ : Maximum rotational speed. This speed may not be exceeded!  
 Notice: Due to  $f_{max} < 5 \cdot f_{rated}$ , the maximum rotational speed is sometimes limited to smaller values.

3

# Servo Motors for SIMOVERT MASTERDRIVES

## Asynchronous Servo Motors

### 1PH4 Motors Water Cooling

#### Selection and Ordering Data with SIMOVERT MASTERDRIVES Motion Control<sup>1)</sup>

Rated Rotational Speed	Shaft Height	Rated Output	Rated Torque	Rated Current	Rated Voltage	Speed during Field Weakening <sup>2)</sup>	Max. Permissible Continuous Speed <sup>3)</sup>	Max. Speed <sup>4)</sup>	1PH4 Asynchronous Motors
$n_{rated}$	SH	$P_{rated}$	$M_{rated}$	$I_{rated}$	$V_{rated}$	$n_1$	$n_{S1}$	$n_{max}$	Order No.
rpm		kW (HP)	Nm (lb <sub>f</sub> -ft)	A	V	rpm	rpm	rpm	
<b>Supply voltage 3-ph. AC 400 V for SIMOVERT MASTERDRIVES Motion Control</b>									
<b>1500</b>	100	7.5 (10.05)	48 (35.4)	20.5	350	2400	3000	3000	<b>1PH4 103 – 4 ■ F56</b>
		11 (14.75)	70 (51.6)	28	350	2100	3000	3000	<b>1PH4 105 – 4 ■ F56</b>
		14 (18.77)	89 (65.6)	35.5	350	2400	3000	3000	<b>1PH4 107 – 4 ■ F56</b>
	132	15 (20.11)	95 (70.1)	35	350	1800	3000	3000	<b>1PH4 133 – 4 ■ F56</b>
		22 (29.49)	140 (103.3)	52	350	2100	3000	3000	<b>1PH4 135 – 4 ■ F56</b>
		27 (36.19)	172 (126.9)	62	350	1900	3000	3000	<b>1PH4 137 – 4 ■ F56</b>
	160	37 (49.6)	236 (174.1)	89	350	2400	3000	3000	<b>1PH4 163 – 4 ■ F56</b>
		46 (61.7)	293 (216.1)	107	350	2200	3000	3000	<b>1PH4 167 – 4 ■ F56</b>
		52 (69.7)	331 (244.1)	117	350	2100	3000	3000	<b>1PH4 168 – 4 ■ F56</b>
<b>Supply voltage 3-ph. AC 480 V for SIMOVERT MASTERDRIVES Motion Control</b>									
<b>1750</b>	100	8.8 (11.8)	48 (35.4)	20.5	400	2800	3500	3500	<b>1PH4 103 – 4 ■ F56</b>
		12.8 (17.16)	70 (51.6)	28	400	2600	3500	3500	<b>1PH4 105 – 4 ■ F56</b>
		16.3 (21.85)	89 (65.6)	35.5	400	2800	3500	3500	<b>1PH4 107 – 4 ■ F56</b>
	132	17.5 (23.46)	96 (70.8)	35.5	400	2100	3500	3500	<b>1PH4 133 – 4 ■ F56</b>
		25.5 (34.18)	139 (102.5)	52	400	2500	3500	3500	<b>1PH4 135 – 4 ■ F56</b>
		31.5 (42.23)	172 (126.9)	63	400	2300	3500	3500	<b>1PH4 137 – 4 ■ F56</b>
	160	43 (57.64)	235 (173.3)	88	400	2800	3500	3500	<b>1PH4 163 – 4 ■ F56</b>
		54 (72.39)	295 (217.6)	107	400	2600	3500	3500	<b>1PH4 167 – 4 ■ F56</b>
		61 (81.77)	333 (245.6)	117	400	2400	3500	3500	<b>1PH4 168 – 4 ■ F56</b>

• **Encoder:**

- Incremental encoder sin/cos 1  $V_{pp}$  (without C track or D track)
- Incremental encoder sin/cos 1  $V_{pp}$  (with C track and D track)
- Absolute encoder EnDat 2,048 pulses/revolution

**N  
M  
E**

# Servo Motors for SIMOVERT MASTERDRIVES

## Asynchronous Servo Motors

1PH4 Motors  
Water Cooling

### Selection and Ordering Data with SIMOVERT MASTERDRIVES Motion Control<sup>1)</sup>

Power Factor	Magnetizing Current $I_{\mu}$ A	Rated Efficiency $\eta_{\text{rated}}$	Rated Frequency $f_{\text{rated}}$ Hz	Moment of inertia $J$ kgm <sup>2</sup> (lb <sub>f</sub> -in-s <sup>2</sup> )	Weight, approx. kg (lb)	1PH4 Asynchronous Motors	SIMOVERT MASTERDRIVES MC Inverter/Converter Rated Current	
						Order No.	$I_{\text{rated}}$ A	Order No.
<b>Supply voltage 3-ph. AC 400 V for SIMOVERT MASTERDRIVES Motion Control</b>								
0.74	12	0.820	52.8	0.017 (0.1504)	52 (114.7)	1PH4 103 -4 . F56	20.5	6SE7 022 - 1 E P50
0.78	13.5	0.836	52.9	0.024 (0.2124)	67 (147.7)	1PH4 105 -4 . F56	34	6SE7 023 - 4 E P50
0.77	18.5	0.851	52.5	0.031 (0.2743)	80 (176.4)	1PH4 107 -4 . F56	37.5	6SE7 023 - 8 D51
0.81	13	0.877	51.8	0.046 (0.4071)	90 (198.5)	1PH4 133 -4 . F56	37.5	6SE7 023 - 8 D51
0.79	24	0.890	51.4	0.071 (0.6283)	112 (247)	1PH4 135 -4 . F56	59	6SE7 026 - 0 D51
0.81	24	0.895	51.5	0.085 (0.7522)	130 (286.7)	1PH4 137 -4 . F56	72	6SE7 027 - 2 D51
0.77	45	0.905	50.9	0.170 (1.5045)	175 (385.9)	1PH4 163 -4 . F56	92	6SE7 031 - 0 E50
0.79	48	0.910	51.0	0.206 (1.8231)	210 (463.1)	1PH4 167 -4 . F56	124	6SE7 031 - 2 F50
0.81	46	0.913	51.0	0.220 (1.947)	240 (529.2)	1PH4 168 -4 . F56	124	6SE7 031 - 2 F50
<b>Supply voltage 3-ph. AC 480 V for SIMOVERT MASTERDRIVES Motion Control</b>								
0.75	11.5	0.841	61.2	0.017 (0.1504)	52 (114.7)	1PH4 103 -4 . F56	25.5	6SE7 022 - 6 C51
0.78	13.5	0.854	61.3	0.024 (0.2124)	67 (147.7)	1PH4 105 -4 . F56	34	6SE7 023 - 4 C51
0.78	18	0.867	61.0	0.031 (0.2743)	80 (176.4)	1PH4 107 -4 . F56	37.5	6SE7 023 - 8 D51
0.82	12	0.887	60.2	0.046 (0.4071)	90 (198.5)	1PH4 133 -4 . F56	37.5	6SE7 023 - 8 D51
0.79	22	0.901	59.8	0.071 (0.6283)	112 (247)	1PH4 135 -4 . F56	59	6SE7 026 - 0 D51
0.81	23	0.905	59.9	0.085 (0.7522)	130 (286.7)	1PH4 137 -4 . F56	72	6SE7 027 - 2 D51
0.78	42	0.914	59.3	0.170 (1.5045)	175 (385.9)	1PH4 163 -4 . F56	92	6SE7 031 - 0 E50
0.80	44	0.920	59.4	0.206 (1.8231)	210 (463.1)	1PH4 167 -4 . F56	124	6SE7 031 - 2 F50
0.82	43	0.921	59.4	0.220 (1.947)	240 (529.2)	1PH4 168 -4 . F56	124	6SE7 031 - 2 F50
Converter Inverter							E T	

1) For rated currents < 37.5 A, Compact PLUS devices are assigned.  
 2)  $n_1$ : Maximum permissible speed at constant power or speed where for  $P = P_{\text{rated}}$ , there is still a 30% power reserve up to the stall limit.  
 3)  $n_{S1}$ : Maximum permissible speed that is continuously permitted without speed duty cycles.

4)  $n_{\text{max}}$ : Maximum rotational speed. This speed may not be exceeded!  
 Notice: Due to  $f_{\text{max}} < 2 \cdot f_{\text{rated}}$ , the maximum rotational speed is sometimes limited to smaller values.

3

# Servo Motors for SIMOVERT MASTERDRIVES

## Asynchronous Servo Motors

Notes

3



# Mounted Parts Geared Motors Gearboxes

# 4



<b>4/2</b>	<b>Encoder Systems</b>
<b>4/4</b>	<b>Holding Brakes</b>
<b>4/9</b>	<b>1FK7 Geared Servo Motors</b>
<b>4/36</b>	<b>Gearboxes for 1FK7 Motors</b>
<b>4/38</b>	<b>Gearboxes for 1FT6 Motors</b>
<b>4/41</b>	<b>Gearboxes for 1PH7 Motors</b>





# Servo Motors for SIMOVERT MASTERDRIVES Mounted Parts

## Encoder Systems

### HTL Incremental Encoder (1,024 Pulses/Revolution and 2,048 Pulses/Revolution)

#### Principle of Operation: Photoelectric Scanning

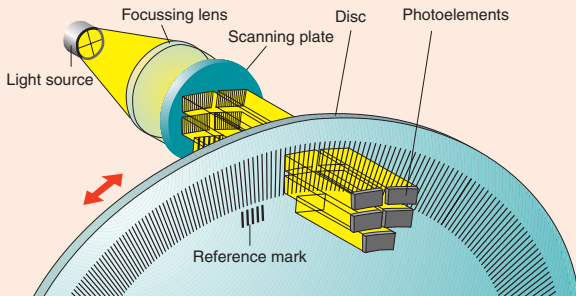

G\_DA65\_EN\_00050a

#### Output Signals

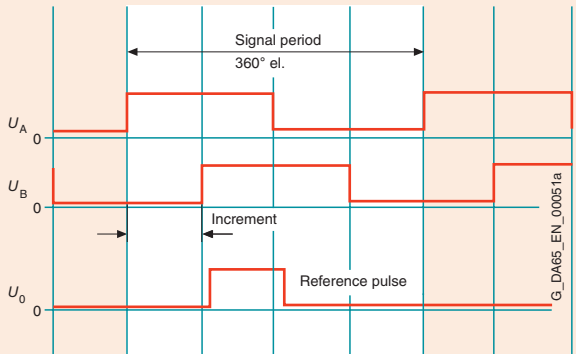

G\_DA65\_EN\_00051a

#### Technical Data

Supply voltage:	+10 to 30 V
Output signals:	HTL Track A, Track B Zero pulse and inverted signals
PPR count:	1,024 (optional: 2,048)
Accuracy:	$\pm 1'$
Limit frequency (-3 dB):	160 kHz
Use:	Asynchronous servo motors 1PH7, 1PL6, 1PH4
Max. possible connection cable length:	
- Without transmission of inverted signals	150 m (492.2 ft)
- With transmission of inverted signals	300 m (984.5 ft)

### Resolver, 2-pole/multipole<sup>1)</sup>

#### Principle of Operation: Inductive Scanning, sin/cos Evaluation for Rotor Position

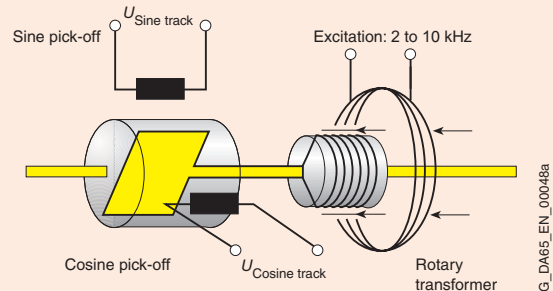

G\_DA65\_EN\_00048a

#### Output Signals

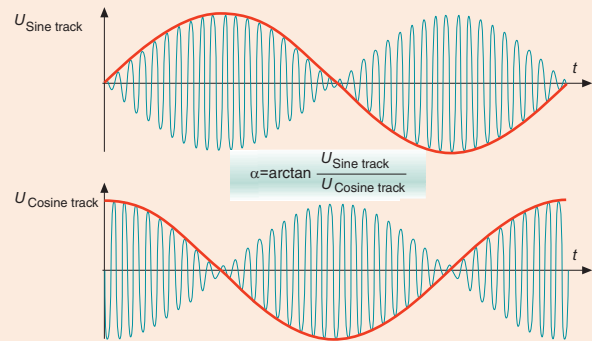

G\_DA65\_EN\_00049a

#### Technical Data

Operating voltage/frequency	+5 V/ 4 kHz
Output signals <sup>2)</sup> :	$U_{\text{sine trace}} = \dot{u} \cdot U_{\text{Excitation}} \cdot \sin \alpha$ $U_{\text{cosine trace}} = \dot{u} \cdot U_{\text{Excitation}} \cdot \cos \alpha$
Ratio:	$\dot{u} = 0.5 \pm 5\%$
Width of the angular error:	< 5' (multipole) < 14' (2-pole) < 20' (2-pole in shaft height 28)
Use:	Synchronous servo motors 1FT6, 1FK7, 1FW3 Asynchronous servo motors 1PH7, 1PH4
Max. possible connection cable length:	150 m (492.2 ft)

1) When a multipole resolver is used, the pole number of the resolver corresponds to that of the motor.

2) Output signals:

- Resolver, 2-pole:  
One sin/cos signal per revolution
- Resolver, 4-pole:  
Two sin/cos signals per revolution
- Resolver, 6-pole:  
Three sin/cos signals per revolution

#### Incremental encoder sin/cos 1 V<sub>pp</sub>

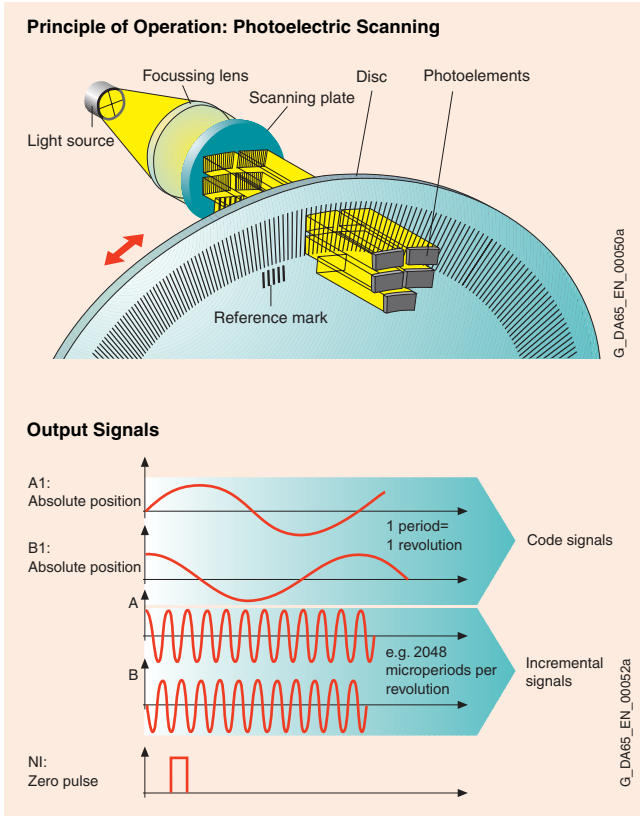

#### Technical Data

Supply voltage:	+5 V ± 5%
Incremental signals (sinewaves):	
• Voltage:	1 V <sub>pp</sub>
• PPR count:	2,048
• Accuracy:	± 40°
Code signals:	
• Voltage:	1 V <sub>pp</sub>
• Signal type (C and D track):	1 sine and 1 cosine signal /revolution
Use:	Synchronous servo motors 1FT6, 1FK7, 1FS6, 1FW3 Asynchronous servo motors 1PH7, 1PL6, 1PH4
Max. possible connection cable length:	100 m (328.2 ft)

Note about principle of operation diagrams:  
These principle of operation diagrams for incremental and absolute encoders have been reprinted with kind permission from the catalog of DR. JOHANNES HEIDENHAIN GmbH, Traunreut, Germany.

#### Absolute Encoder (EnDat)

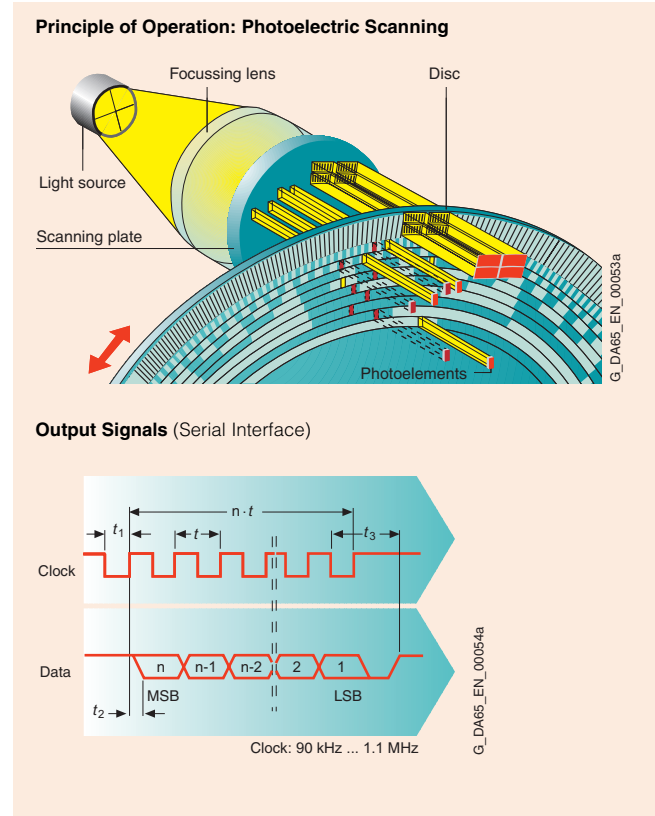

#### Technical Data

Supply voltage:	+5 V ± 5%
Incremental signals (sinewaves):	
• Voltage:	1 V <sub>pp</sub>
• PPR count:	2,048 / 512 / 32 <sup>1)</sup>
• Accuracy:	± 40° / ± 80° / ± 400°
Code signals:	Synchronous serial EnDat interface Dual code 4,096 encoded revolutions
Use:	Synchronous servo motors 1FT6, 1FK7, 1FS6, 1FW3 Asynchronous servo motors 1PH7, 1PL6, 1PH4
Max. possible connection cable length:	100 m (328.2 ft)

1) Absolute encoder (EnDat) with 2,048 pulses/revolution for motors 1FT6, 1FK7, and 1FS6 for shaft height 48 and higher; 1FW3 and all asynchronous motors.

• Absolute encoder (EnDat) with 512 pulses/revolution for 1FT6 motors for shaft height 28 and 1FK7 motors for shaft heights 28 and 36.  
• Simple absolute encoder (EnDat) with 32 pulses/revolution for 1FK7 motors, axis height 48 and higher

# Servo Motors for SIMOVERT MASTERDRIVES

## Mounted Parts

### Holding Brakes

Because of the processes involved or for safety reasons, many drives need a holding brake with an emergency stop function. A holding brake can be attached to the motor in two ways.

1. An integrated (built-in) holding brake in motors 1FK7 and 1FT6
2. An attached (built-on) holding brake on the external drive end of the 1PH7 motors

### Built-In Holding Brakes for 1FK7 and 1FT6 Motors

The permanent-magnet or fail-safe single-face brakes implemented in these motor series operate according to the closed-circuit current principle. The magnetic field of the permanent magnet exerts a pull on the armature plate of the brake, i.e., in a de-energized state, the brake closes and causes the motor shaft to stop. When the rated voltage of 24 V DC is applied to the brake, current flows through the coil and produces a counter-field that cancels the pull of the permanent magnet, causing the brake to release.

The spring-operated single-face brake operates by the force of pressure exerted by the spring instead of a permanent magnet.

In the event of an emergency stop or power outage, approximately 2,000 braking operations can be performed with the maximum switched energy without causing excessive wear on the holding brake (condition: maximum external moment of inertia = moment of inertia of motor and  $\eta_{\max}$ , type-specific).

The holding brake is not an operational brake.

To prevent the occurrence of overvoltages on circuit interruption and any effects this could have on the plant environment, the brake supply cable must be connected externally to a varistor. This is done via the power connector or terminal box.

Refer to the table below for technical data.

# Servo Motors for SIMOVERT MASTERDRIVES

## Mounted Parts

### Holding Brakes

#### Technical Data for Built-In Holding Brakes (Brake Supply Voltage 24 V DC $\pm$ 10%)

Size	Motor Type	Brake Type	Holding Torque	DC Current	Opening Time with Varistor	Closing Time with Varistor	Moment of Inertia	Maximum Switched Energy per Brake Operation from $n = 3,000$ rpm
			Nm (lb <sub>f</sub> -ft)	A	ms	ms	$10^{-4}$ kgm <sup>2</sup> (lb <sub>f</sub> -in-s <sup>2</sup> )	J (lb <sub>f</sub> -in)
<b>For 1FK7 CT Motors</b>								
28	1FK7 022	EBD 0.11 BN	1.1 (0.8)	0.3	25	15	0.07 (0.00006)	8 (70.8)
36	1FK7 032	EBD 0.13 BN	1.3 (1)	0.4	45	25	0.08 (0.00071)	17 (150.5)
48	1FK7 04.	EBD 0,3 BV	3.8 (2.8)	0.6	70	20	0.72 (0.00064)	74 (655)
63	1FK7 06.	EBD 0,8 BK	13.2 (9.7)	0.8	90	20	2.25 (0.00199)	350 (3097.9)
80	1FK7 080	EBD 1.5 BN	10 (7.3)	0.7	90	20	3.1 (0.00274)	400 (3540.4)
80	1FK7 083	EBD 2 BY	22 (16.2)	0.9	125	65	8.6 (0.00761)	1400 (12391.4)
100	1FK7 100	EBD 2 BY	22 (16.2)	0.9	125	65	8.6 (0.00761)	1400 (12391.4)
100	1FK7 101/103/105	EBD 3.5 BV	41 (30.2)	1.0	250	70	13.5 (0.01195)	3000 (26550)
<b>For 1FK7 HD Motors</b>								
36	1FK7 033	1EB 14	1.3 (1)	0.45	70	35	0.12 (0.00011)	14 (123.9)
48	1FK7 04.	1EB 20	4 (3)	0.6	110	40	0.13 (0.00012)	96 (849.6)
63	1FK7 06.	1EB 28	12 (8.9)	0.8	150	45	0.34 (0.00030)	230 (2035.5)
80	1FK7 08.	1EB 35	22 (16.2)	1.2	190	50	2.0 (0.00177)	700 (6195)
<b>For 1FT6 Motors</b>								
28	1FT6 02.	EBD 0.11 B	1.2 (0.9)	0.3	20	10	0.07 (0.00006)	34 (300.9)
36	1FT6 03.	EBD 0.15 B	2 (1.5)	0.4	30	15	0.12 (0.00011)	27 (238.9)
48	1FT6 04.	EBD 0.4 BA	5 (3.7)	0.8	30	15	1.06 (0.00094)	126 (1115.1)
63	1FT6 06.	EBD 1.5 BN	22 (16.2)	0.7	130	20	3.2 (0.00283)	321 (2840.9)
80	1FT6 081/082	EBD 1.2 B	12 (8.9)	0.8	70	35	3.2 (0.00283)	740 (6549)
80	1FT6 084/086	EBD 3.5 BN	28 (20.7)	0.9	180	35	13.5 (0.01195)	1640 (14514)
100	1FT6 10.	EBD 4 B	80 (59)	1.4	180	20	32 (0.02832)	2150 (19027.5)
132	1FT6 13.	EBD 8 B	140 (103.3)	1.7	260	70	76 (0.06726)	9870 (87349.5)

# Servo Motors for SIMOVERT MASTERDRIVES

## Mounted Parts

### Holding Brakes

#### Built-On Holding Brakes for 1PH7 Motors

A brake can be built onto the drive end of 1PH7 motors with shaft heights 100, 132, 160, 180, and 225.

These brakes are electromagnetic devices for dry running in which the force of an electromagnetic field is used to cancel the braking action generated by spring force. They operate according to the closed-circuit current principle, i.e., in a de-energized state, the spring-operated brake is applied, causing the motor to stop. When current is flowing, the brake is released, allowing the motor to rotate.

In the event of a power outage or emergency stop, the drive is slowed from its current rotational speed until it comes to a standstill. The holding torques and number of emergency stops are indicated in the table on page 4/7.

These brakes can be connected at 230 V AC, 50 to 60 Hz or 24 V DC (only up to size 160), which must be supplied plant-side.

The rectifier is integrated in the terminal box of the brake. The degree of protection is IP55.

The basic model of this brake has three emergency release screws (only for shaft heights 180 and 225), which can be accessed axially from the front. The integrated or attached microcircuit can be linked to a higher-lever controller as an NC contact or an NO contact. The fast-switching rectifier over-excites the coil to release the brake and achieve faster release times (release current = 2 x holding current).

All technical data, such as holding torque, permissible rotational speeds, number of emergency braking operations, and braking currents are indicated in the table on page 4/7.

The operating instructions for the built-on holding brake are supplied with the motor-brake unit.

Order example: 1PH7 186-2HF00-2AA3

Construction type IM B3, holding brake includes microcircuit and emergency release screw (for additional ordering options, see also the order number key on page 4/7).

#### Built-On Holding Brake for Motors with Shaft Heights 100 to 160

The holding brake for motors with shaft heights 100, 132, and 160 are brake modules (manufactured by Binder) with their own bearing, flange, and shaft end. The flange and shaft end of the brake module have the same dimensions as those of the motor. A motor that is supposed to have a brake installed has a flange construction type and a keyless shaft (no key). The shaft of the brake module can then be shrunk onto the motor shaft. It can be uninstalled with an oil press-fit assembly. The brake module is then screwed onto the motor flange. The shaft end on the brake module receives a key (with half-key balancing).

The output can take place by means of a coupling or a belt. The permissible cantilever forces are indicated in the relevant cantilever force diagrams.

1PH7 motors (shaft heights 100 and 132) are available as construction type IM B5; in addition, motors with shaft heights 100, 132, and 160 are also available as IM B 35 (and foot-mounting type IM B3 is also available).

A manual release can also be added to the brake module, allowing for manual release of the brake in the event of a power outage or motor standstill. When the manual release lever is released, it automatically springs back to braking state. Another available option is an attached microcircuit that can be connected to a higher-lever controller as an NC or NO contact. The microcircuit is connected by means of a separately fed-out cable.

The brake module complies with degree of protection IP55. Motors with a built-on brake module are only available with vibration severity grade N and shaft and flange accuracy N.

All technical data, such as holding torque, maximum braking energy, permissible rotational speeds, cantilever forces, and braking currents are indicated in the table on page 4/7.

Order example: 1PH7 137-2HF02-3KB3

Construction type IM B5, holding brake with manual release (for additional ordering options, see also the order number key on page 4/7).

#### Built-On Holding Brake for 1PH7 Motors Shaft Height 180 and 225

In these motors, the brake (manufactured by Stromag) is attached to the drive-end shield. To this end, the motor shaft length is increased by means of a shrunk-on insertable shaft. Torque transfer takes place by means of a key in accordance with DIN 6885/1. The insertable shaft can also be secured axially with a thrust washer and a center screw (M20). The holding brake has no bearing of its own. Therefore, the output forces are absorbed in the motor bearings. Due to the limited space available and the high cantilever forces involved, belt pulleys cannot be attached. When selecting a coupling to connect to the motor-brake combination, ensure that the diameter of the shaft end is now greater than the diameter of the motor shaft end. The preferred couplings are REVOLUX pin couplings in model 2LF6337 for shaft height 180 and 2LF6338 for shaft height 225.

For ordering data and dimensions, see Calatog M 11.

# Servo Motors for SIMOVERT MASTERDRIVES

## Mounted Parts

### Holding Brakes

#### Built-On Holding Brakes for 1PH7 Motors (continued)

#### Technical Data for Built-On Holding Brakes with Emergency Stop Function (Brake Supply Voltage 230 V AC, 50 to 60 Hz/ 24 V DC +5% -10%)

Shaft Height	Motor Type	Brake Type	Holding Torque (Tolerance ±20%)	Speed $n_{max}$	Permiss. Single Switched Energy $W_S$	Life-time Switched Energy $W_{max}$	No. Emergency Stops before Lining Change from $n_{max}$ at $J$ $z$	Coil Current		Flange Diameter DIN 42 948	Shaft End Diameter DIN 748 Ø Length	Permiss. Cantilever Force (3000 rpm, $x_{max}$ )	Moment of Inertia of Brake	Brake Weight	Opening Time	Closing Time		
								AC	DC									
			Nm (lb <sub>f</sub> -ft)	rpm	kJ (lb <sub>f</sub> -ft x 10 <sup>3</sup> )	MJ (lb <sub>f</sub> -ft x 10 <sup>6</sup> )	-	A	A		mm (in)	mm (in)	N (lb <sub>f</sub> )	kgm <sup>2</sup> (lb <sub>f</sub> -in-s <sup>2</sup> )	kg (lb)	ms	ms	
100	<b>1PH710. Size 19</b>		60 to 150 (44 to 111)	5500	25 (18.4)	90 (66.4)	8700 (0.5487)	0.062 (0.5487)	1.0	4.7	A250	38 (1.5)	80 (3.1)	2300 (517)	0.005 (0.0442)	21 (46)	255	60
132	<b>1PH713. Size 24</b>		140 to 310 (103 to 229)	4500	40 (29.5)	226 (166.7)	9400 (1.8407)	0.208 (1.8407)	1.3	6.3	A350	42 (1.7)	110 (4.3)	2000 (450)	0.015 (0.1327)	46 (101)	330	95
160	<b>1PH716. Size 29</b>		280 to 500 (207 to 369)	3700	60 (44.3)	401 (295.8)	11900 (3.9646)	0.448 (3.9646)	1.35	6.7	A400	55 (2.2)	110 (4.3)	6800 (1528)	0.028 (0.2478)	66 (145)	350	450
180	<b>1PH7184 NFE 60</b>		600 (443)	3500	69 (50.9)	154 (113.6)	2230 (9.0265)	1.02 (9.0265)	0.9	-	-	90 (3.5)	90 (3.5)	2800 (629)	0.027 (0.2389)	55 (121)	400	160
	<b>1PH7186 NFE 800</b>		800 (590)		91 (67.1)	56 (41.3)	620 (12.0364)	1.36 (12.0364)	-	-	-	-	-	-	0.026 (0.2301)	-	-	-
	<b>60/80</b>																	
225	<b>1PH7224 NFE 100</b>		1000 (738)	3100	158 (116.5)	153 (112.9)	970 (26.5487)	3 (26.5487)	1.3	-	-	100 (3.9)	100 (3.9)	2800 (629)	0.041 (0.3628)	75 (165)	460	200
	<b>1PH7226 NFE 100</b>		1000 (738)		206 (151.9)	109 (80.4)	530 (24.5133)	3.9 (24.5133)	-	-	-	-	-	-	0.041 (0.3628)	-	-	-
	<b>1PH7228 NFE 1400</b>		1400 (1033)		248 (182.9)	32 (23.6)	130 (41.59)	4.7 (41.59)	-	-	-	-	-	-	0.041 (0.3628)	-	-	-
	<b>100/140</b>																	

**Holding torque in Nm:** For motors with a shaft height of 100 to 160, a setting ring is used for infinite adjustment of the holding torque within the specified range. The dynamic braking torque is approximately 0.7 to 0.8 x the holding torque.

**Speed  $n_{max}$ :** Maximum permissible rotational speed at which an emergency stop is possible.

**Permissible single switched energy  $W_S$  in kJ:** Permissible switched energy during an emergency stop,  $W_S = J_{total} \times n^2 / 182.5 \times 10^{-3}$  (J in kgm<sup>2</sup>, n in rpm) ( $W_S = J_{total} \times n^2 / 1.6151 \times 10^{-3}$ ; J in lb<sub>f</sub>-in-s<sup>2</sup>, n in rpm)

**Lifetime switched energy  $W_{max}$  in MJ:** Maximum possible switched energy of the brake (during an emergency stop) before the brake linings must be replaced,  $W_{max} = W_S \times z$ .

**No. of emergency stops  $z$ :** The specified number of emergency stops relates to the following conditions: Braking from speed  $n_{max}$ ,  $J_{total} = 2 \times J_{mot}$ . The following conversion can be made for different conditions: Number of emergency stops  $z = W_{max} / W_S$

**Coil current in A:** Current required to keep the brake in a released state. For NFE brakes: Release current = 2 x holding current

**Permissible cantilever force in N:** Motors with a shaft height of 100 to 160 can have both coupling drives and belt drives, but motors with an axis height of 180 or 255 can only have coupling drives.

**Opening time in ms:** Separation time before the brake opens (specified values refer to maximum braking torque)

**Closing time in ms:** Connection time before the brake closes (specified values refer to maximum braking torque)

# Servo Motors for SIMOVERT MASTERDRIVES Mounted Parts

## Holding Brakes

### Order Number Key for 1PH7 Shaft Height 100, 132, and 160 for Built-On Holding Brake with Emergency Stop Function

1 2 3 4 5 6 7 8 9 10 11 12 13 14 15 16  
**1 PH7 . . . . - . . . . . 0 - AA . . .**

Without brake	0
Brake supply voltage: 230 V AC, 50 – 60 Hz	
With brake (brake supply voltage: 230 V AC, 50–60 Hz)	1
With brake (brake includes microcircuit)	2
With brake (brake includes manual release)	3
With brake (brake includes microcircuit and manual release)	4
Brake supply voltage: 24 V DC	
With brake (brake supply voltage: 24 V DC)	5
With brake (brake includes microcircuit)	6
With brake (brake includes manual release)	7
With brake (brake includes microcircuit and manual release)	8

- Models with brake are only available in the following combinations:
- Vibration severity grade N, shaft and flange accuracy N (“K” in position 14)
  - Shaft end on brake module with key and half-key balancing (“A” or “B” in position 15) or keyless shaft end (“J” or “K” in position 15)
  - Type IM B5 (only for sizes 100 and 132; “2” in position 12) or IM B35 (“3” in position 12; foot-mounting type IM B3 is available)
  - and “0”, “3”, or “6” in position 16.

### Order Number Key for 1PH7 Shaft Height 180 and 225 for Built-On Holding Brake with Emergency Stop Function

1 2 3 4 5 6 7 8 9 10 11 12 13 14 15 16  
**1 PH7 . . . . - . . . . 0 - AA . . .**

Without brake	0
With brake (brake includes microcircuit and emergency release screw)	2
With brake (brake includes microcircuit and manual release)	4

- Models 2 and 4 are only available as construction type IM B3, i.e.:
- Only “0” in position 12
  - Only “A” in position 14
  - Only “A” in position 15
  - Only “0”, “3”, or “6” in position 16

4

#### Overview



1FK7 Geared Servo Motors

1FK7 geared servo motors are composed of the 1FK7 servo motors presented in Part 2 and the directly attached helical gears and angular gears.

1FK7 geared servo motors are fully assembled, complete units that come supplied with an oil-filled gearbox. This family of motors includes helical geared motors in 9 sizes, offset shaft geared motors in 5 sizes, bevel geared motors in 8 sizes, and worm geared motors in 5 sizes. A wide variety of mechanical attachments can be implemented with these many options.

1FK7 geared servo motors are designed for operation without external cooling whereby generated heat is dissipated through the motor surface.

Combined with the SIMOVERT MASTERDRIVES Motion Control drive system, 1FK7 geared servo motors form a powerful high-performance system. As with 1FK7 servo motors, the built-in encoder systems for speed and position control can be selected specifically for the application.

#### Uses/Benefits

##### *Features of 1FK7 geared servo motors:*

- Very compact design due to direct attachment (no coupling locks between motor and gearbox)
- Maintenance-free lifetime lubrication (except for worm gearbox)
- High efficiency
- Small torsional backlash
- Helical gearing ensures quiet running
- Gearing rated for endurance strength (except for worm gearbox)
- Suitable for cyclic operation with varying load and continuous duty
- Economical solution compared to planetary geared motors

#### Application

1FK7 geared servo motors are very well suited for simple positioning tasks and continuously running, servo-quality auxiliary drives in general mechanical engineering applications, such as:

- Packaging machines
- Stacker cranes
- Woodworking, glass, and ceramics machines
- Bottling plants
- Conveyor belts



# Servo Motors for SIMOVERT MASTERDRIVES

## Synchronous Servo Motors

### 1FK7 Geared Servo Motors

#### Technical Data

##### Helical Geared Motors

Nominal ratio	$i_{nom} = 3.8$ to 70
Rated output torque	$M_2 = 46$ Nm (33.9 lb <sub>f</sub> -ft) to 1370 Nm (1010.5 lb <sub>f</sub> -ft)
Max. permiss. acceleration torque	$M_{2max} = 65$ Nm (47.9 lb <sub>f</sub> -ft) to 4140 Nm (3053.7 lb <sub>f</sub> -ft)
Torsional backlash	10 arcmin to 20 arcmin
Efficiency	94% to 96%
Mechanical options	Solid shaft with key, flange, base, tapped hole group

##### Offset Shaft Geared Motors

Nominal ratio	$i_{nom} = 4.3$ to 35
Rated output torque	$M_2 = 58$ Nm (42.8 lb <sub>f</sub> -ft) to 529 Nm (390.2 lb <sub>f</sub> -ft)
Max. permiss. acceleration torque	$M_{2max} = 120$ Nm (88.5 lb <sub>f</sub> -ft) to 1100 Nm (811.4 lb <sub>f</sub> -ft)
Torsional backlash	10 arcmin to 11 arcmin
Efficiency	94% to 96%
Mechanical options	Solid shaft, hollow shaft with key, hollow shaft with tensioning element/shrink disk, base, tapped hole group

##### Bevel Geared Motor

Nominal ratio	$i_{nom} = 4$ to 76
Rated output torque	$M_2 = 89$ Nm (65.6 lb <sub>f</sub> -ft) to 1280 Nm (944.1 lb <sub>f</sub> -ft)
Max. permiss. acceleration torque	$M_{2max} = 135$ Nm (99.6 lb <sub>f</sub> -ft) to 4650 Nm (3429.8 lb <sub>f</sub> -ft)
Torsional backlash	10 arcmin to 12 arcmin
Efficiency	94% to 96%
Mechanical options	Solid shaft, hollow shaft with key, hollow shaft with tensioning element/shrink disk, base, tapped hole group

##### Worm Geared Motors

Nominal ratio	$i_{nom} = 9.2$ to 70
Rated output torque	$M_2 = 80$ Nm (59 lb <sub>f</sub> -ft) to 430 Nm (317.2 lb <sub>f</sub> -ft)
Max. permiss. acceleration torque	$M_{2max} = 96$ Nm (70.8 lb <sub>f</sub> -ft) to 720 Nm (531.1 lb <sub>f</sub> -ft)
Torsional backlash	Adjustable, average approx. 13 arcmin
Mechanical options	Solid shaft, hollow shaft with key, hollow shaft with tensioning element/shrink disk, base, tapped hole group

A CD-ROM with the "SGM Designer" program is available to help you select, order, and configure your geared motors (order no. E86060-D5202-A100-A2). This CD-ROM contains all of the data and dimension diagrams for the 2KG.. geared motors and the 1FK7 geared servo motors. The same "SGM Designer" program can be accessed online at:

[www.siemens.com/sgmdesigner](http://www.siemens.com/sgmdesigner)

You can also use the "SGM Designer" program to create dimension drawings in 3D.

This program was configured by it-motive, a system vendor and consulting firm located in Duisburg, Germany ([www.it-motive.com](http://www.it-motive.com)).

#### Selection and Ordering Data

##### Definition of Terms in the Selection Tables

$P_2$	kW (HP)	Mechanical output on the gear shaft (in S3 duty)
$n_2$	rpm	Output speed of gear in relation to the input speed of the motor of $n_1 = 3000$ rpm for a horizontal gear shaft output
$M_2$	Nm (lb <sub>f</sub> -ft)	Rated output torque of gear in S3 duty
$M_{2max}$	Nm (lb <sub>f</sub> -ft)	Maximum permissible acceleration torque of gear
$i_{nom}$		Nominal gear ratio (approximate value as decimal number)
$i_{exact}$		Exact gear ratio (indicated as a fraction of parameter input in converter)
$F_{rpermis}$	N	Maximum permissible cantilever force on gear shaft end
$f_B$		Overload factor of gear (quotient between maximum permissible acceleration torque and standstill torque of motor and gear ratio)
		Gear size (identifier for gear type and gear size)
<b>SH</b>		Motor size (1FK7 motors are available in shaft heights, 36, 48, 63, 80, and 100)
<b>Order Codes</b>		These Order Codes indicate the gear type, size, ratio, and mechanical design
<b>Weight</b>	kg (lb)	Total weight of gearbox motor

# Servo Motors for SIMOVERT MASTERDRIVES

## Synchronous Servo Motors

### 1FK7 Geared Servo Motors Helical Geared Motors

#### Selection and Ordering Data

Output (S3 60%)	Output Speed	Rated Output Torque	Max. Permiss. Acceleration Torque	Nominal Ratio	Exact Ratio	Cantilever Force Gear Shaft End	Overload Factor
$P_2$ kW (HP)	$n_2$ rpm	$M_2$ Nm (lb <sub>f</sub> -ft)	$M_{2max}$ Nm (lb <sub>f</sub> -ft)	$i_{nom}$	$i_{exact}$	$F_{rperm}$ N (lb <sub>f</sub> )	$f_B$
<b>0.30 (0.40)</b>	782	3.63 (2.7)	19 (14)	3.8	441/115	560 (126)	4.2
	476	5.96 (4.4)	29 (21.4)	6.3	2035/323	660 (148)	3.9
	291	9.74 (7.2)	51 (37.6)	10.5	1421/138	778 (174.9)	4.2
	192	14.8 (10.9)	72 (53.1)	15.5	1595/102	894 (200.9)	3.9
	129	22 (16.2)	65 (47.9)	23	325/14	1020 (229.3)	2.4
86	33.1 (24.4)	65 (47.9)	35	1261/36	1170 (263)	1.6	
<b>0.41 (0.55)</b>	64	44.3 (32.7)	65 (47.9)	47	7865/168	1289 (289.7)	1.2
	43	66.6 (49.2)	138 (101.8)	70	775/11	2099 (471.9)	1.7
	782	5.02 (3.7)	36 (26.6)	3.8	441/115	560 (125.9)	6.0
	476	8.25 (6.1)	55 (40.6)	6.3	2035/323	660 (148.4)	5.6
	291	13.5 (10)	72 (53.1)	10.5	1421/138	778 (174.9)	4.5
192	20.5 (15.1)	72 (53.1)	15.5	1595/102	894 (200.9)	3.0	
<b>0.79 (1.06)</b>	128	30.8 (22.7)	138 (101.8)	24	1035/44	1456 (327.3)	3.8
	129	30.4 (22.4)	65 (47.9)	23	325/14	1020 (229.3)	1.8
	86	45.9 (33.9)	138 (101.8)	35	2700/77	1663 (373.9)	2.5
	86	45.9 (33.9)	65 (47.9)	35	1261/36	1170 (263)	1.2
	64	61.4 (45.3)	138 (101.8)	47	516/11	1833 (412)	1.9
<b>0.79 (1.06)</b>	782	9.67 (7.1)	36 (26.6)	3.8	441/115	560 (126.9)	3.2
	476	15.9 (11.7)	55 (40.6)	6.3	2035/323	660 (148.4)	3.0
	291	26 (19.2)	72 (53.1)	10.5	1421/138	778 (174.9)	2.4
	191	39.6 (29.2)	138 (101.8)	15.5	377/24	1273 (286.2)	3.0
	192	39.4 (29.1)	72 (53.1)	15.5	1595/102	894 (200.1)	1.6
128	59.3 (43.7)	138 (101.8)	24	1035/44	1456 (327.3)	2.0	
<b>1.43 (1.92)</b>	86	88.4 (65.2)	138 (101.8)	35	2700/77	1663 (373.9)	1.4
	64	118 (87)	138 (101.8)	47	516/11	1833 (412)	1.0
	782	17.5 (12.9)	50 (36.9)	3.8	441/115	560 (125.9)	2.2
	476	28.7 (21.2)	59 (43.5)	6.3	2035/323	660 (148.4)	1.6
	511	26.8 (19.8)	102 (75.2)	6.3	47/8	917 (206.1)	3.0
291	46.9 (34.6)	72 (53.1)	10.5	1421/138	778 (174.9)	1.2	
<b>1.43 (1.92)</b>	289	47.3 (34.9)	138 (101.8)	10.5	841/81	1109 (249.3)	2.3
	191	71.6 (52.8)	138 (101.8)	15.5	377/24	1273 (286.1)	1.5
	196	69.7 (51.4)	230 (169.7)	15.5	703/46	1775 (399)	2.6
	128	107 (78.9)	138 (101.8)	25	1035/44	1456 (327.3)	1.0
	128	107 (78.9)	350 (258.2)	24	845/36	3045 (684.5)	2.6
<b>1.42 (1.9)</b>	85	160 (118)	230 (169.6)	35	1372/39	2343 (526.7)	1.1
<b>1.43 (1.92)</b>	86	159 (117.3)	550 (405.7)	35	975/28	5961 (1340)	2.7
	60	227 (167.4)	400 (295)	50	2736/55	3911 (879.2)	1.4
<b>1.44 (1.93)</b>	60	229 (168.9)	600 (442.6)	50	1305/26	6734 (1513.8)	2.1
	43	319 (235.3)	550 (405.7)	70	559/8	7519 (1690.3)	1.4
	43	319 (235.3)	850 (627)	70	10075/144	9229 (2074.8)	2.1

# Servo Motors for SIMOVERT MASTERDRIVES

## Synchronous Servo Motors

1FK7 Geared Servo Motors  
Helical Geared Motors

Gear Size	Motor Type	SH	Helical Geared Motors		Order codes			Approx. Total Weight kg (lb)
			Order No.	Gearbox Type	Type of Construction	Mounting Position Type		
C002	36	36	1FK7032 – 5AK71 – 1 ■ ■ 5 – Z	D01	G ■ ■	H ■ ■	8.6 (19)	
C002	36	36	1FK7032 – 5AK71 – 1 ■ ■ 5 – Z	D02	G ■ ■	H ■ ■	8.6 (19)	
C002	36	36	1FK7032 – 5AK71 – 1 ■ ■ 5 – Z	D03	G ■ ■	H ■ ■	8.6 (19)	
C002	36	36	1FK7032 – 5AK71 – 1 ■ ■ 5 – Z	D04	G ■ ■	H ■ ■	8.6 (19)	
C002	36	36	1FK7032 – 5AK71 – 1 ■ ■ 5 – Z	D05	G ■ ■	H ■ ■	8.6 (19)	
C002	36	36	1FK7032 – 5AK71 – 1 ■ ■ 5 – Z	D06	G ■ ■	H ■ ■	8.6 (19)	
C002	36	36	1FK7032 – 5AK71 – 1 ■ ■ 5 – Z	D07	G ■ ■	H ■ ■	8.6 (19)	
C102	36	36	1FK7032 – 5AK71 – 1 ■ ■ 5 – Z	D18	G ■ ■	H ■ ■	13.5 (29.8)	
C002	48	48	1FK7040 – 5AK71 – 1 ■ ■ 5 – Z	D01	G ■ ■	H ■ ■	9.4 (20.7)	
C002	48	48	1FK7040 – 5AK71 – 1 ■ ■ 5 – Z	D02	G ■ ■	H ■ ■	9.4 (20.7)	
C002	48	48	1FK7040 – 5AK71 – 1 ■ ■ 5 – Z	D03	G ■ ■	H ■ ■	9.4 (20.7)	
C002	48	48	1FK7040 – 5AK71 – 1 ■ ■ 5 – Z	D04	G ■ ■	H ■ ■	9.4 (20.7)	
C102	48	48	1FK7040 – 5AK71 – 1 ■ ■ 5 – Z	D15	G ■ ■	H ■ ■	14.3 (31.5)	
C002	48	48	1FK7040 – 5AK71 – 1 ■ ■ 5 – Z	D05	G ■ ■	H ■ ■	9.4 (20.7)	
C102	48	48	1FK7040 – 5AK71 – 1 ■ ■ 5 – Z	D16	G ■ ■	H ■ ■	14.3 (31.5)	
C002	48	48	1FK7040 – 5AK71 – 1 ■ ■ 5 – Z	D06	G ■ ■	H ■ ■	9.4 (20.7)	
C102	48	48	1FK7040 – 5AK71 – 1 ■ ■ 5 – Z	D17	G ■ ■	H ■ ■	14.3 (31.5)	
C002	48	48	1FK7042 – 5AF71 – 1 ■ ■ 5 – Z	D01	G ■ ■	H ■ ■	10.7 (23.6)	
C002	48	48	1FK7042 – 5AF71 – 1 ■ ■ 5 – Z	D02	G ■ ■	H ■ ■	10.7 (23.6)	
C002	48	48	1FK7042 – 5AF71 – 1 ■ ■ 5 – Z	D03	G ■ ■	H ■ ■	10.7 (23.6)	
C102	48	48	1FK7042 – 5AF71 – 1 ■ ■ 5 – Z	D14	G ■ ■	H ■ ■	15.6 (34.4)	
C002	48	48	1FK7042 – 5AF71 – 1 ■ ■ 5 – Z	D04	G ■ ■	H ■ ■	10.7 (23.6)	
C102	48	48	1FK7042 – 5AF71 – 1 ■ ■ 5 – Z	D15	G ■ ■	H ■ ■	15.6 (34.4)	
C102	48	48	1FK7042 – 5AF71 – 1 ■ ■ 5 – Z	D16	G ■ ■	H ■ ■	15.6 (34.4)	
C102	48	48	1FK7042 – 5AF71 – 1 ■ ■ 5 – Z	D17	G ■ ■	H ■ ■	15.6 (34.4)	
C002	63	63	1FK7060 – 5AF71 – 1 ■ ■ 5 – Z	D01	G ■ ■	H ■ ■	13.4 (29.5)	
C002	63	63	1FK7060 – 5AF71 – 1 ■ ■ 5 – Z	D02	G ■ ■	H ■ ■	13.4 (29.5)	
C102	63	63	1FK7060 – 5AF71 – 1 ■ ■ 5 – Z	D12	G ■ ■	H ■ ■	18.3 (40.4)	
C002	63	63	1FK7060 – 5AF71 – 1 ■ ■ 5 – Z	D03	G ■ ■	H ■ ■	13.4 (29.5)	
C102	63	63	1FK7060 – 5AF71 – 1 ■ ■ 5 – Z	D13	G ■ ■	H ■ ■	18.3 (40.4)	
C102	63	63	1FK7060 – 5AF71 – 1 ■ ■ 5 – Z	D14	G ■ ■	H ■ ■	18.3 (40.4)	
C202	63	63	1FK7060 – 5AF71 – 1 ■ ■ 5 – Z	D24	G ■ ■	H ■ ■	22.3 (49.2)	
C102	63	63	1FK7060 – 5AF71 – 1 ■ ■ 5 – Z	D15	G ■ ■	H ■ ■	18.3 (40.4)	
C302	63	63	1FK7060 – 5AF71 – 1 ■ ■ 5 – Z	D35	G ■ ■	H ■ ■	27.4 (60.4)	
C202	63	63	1FK7060 – 5AF71 – 1 ■ ■ 5 – Z	D26	G ■ ■	H ■ ■	22.3 (49.2)	
C402	63	63	1FK7060 – 5AF71 – 1 ■ ■ 5 – Z	D46	G ■ ■	H ■ ■	37.6 (82.9)	
C302	63	63	1FK7060 – 5AF71 – 1 ■ ■ 5 – Z	D37	G ■ ■	H ■ ■	27.4 (60.4)	
C402	63	63	1FK7060 – 5AF71 – 1 ■ ■ 5 – Z	D47	G ■ ■	H ■ ■	37.6 (82.9)	
C402	63	63	1FK7060 – 5AF71 – 1 ■ ■ 5 – Z	D48	G ■ ■	H ■ ■	37.6 (82.9)	
C502	63	63	1FK7060 – 5AF71 – 1 ■ ■ 5 – Z	D58	G ■ ■	H ■ ■	49.2 (108.5)	
<ul style="list-style-type: none"> <li>Encoder system in motor:</li> </ul>		<ul style="list-style-type: none"> <li>Incremental encoder sin/cos 1 V<sub>pp</sub></li> <li>Absolute encoder EnDat 2,048 pulses/revolution (shaft height 48 and higher)</li> <li>Absolute encoder EnDat 512 pulses/revolution (shaft height 36 only)</li> <li>Simple absolute encoder EnDat 32 pulses/revolution (shaft height 48 and higher)</li> <li>Resolver, multipole (pole number = pole number for motor)</li> <li>Resolver, 2-pole</li> </ul>	<ul style="list-style-type: none"> <li>A</li> <li>E</li> <li>H</li> <li>G</li> <li>S</li> <li>T</li> </ul>					
<ul style="list-style-type: none"> <li>Holding brake:</li> </ul>		<ul style="list-style-type: none"> <li>Motor <b>without</b> holding brake</li> <li>Motor <b>with</b> holding brake</li> </ul>	<ul style="list-style-type: none"> <li>U</li> <li>V</li> </ul>					

For order codes for type of construction, design, and mounting position, see 4/32

# Servo Motors for SIMOVERT MASTERDRIVES

## Synchronous Servo Motors

### 1FK7 Geared Servo Motors Helical Geared Motors

#### Selection and Ordering Data

Output (S3 60%) $P_2$ kW (HP)	Output Speed $n_2$ rpm	Rated Output Torque $M_2$ Nm (lb <sub>f</sub> -ft)	Max. Permiss. Acceleration Torque $M_{2max}$ Nm (lb <sub>f</sub> -ft)	Nominal Ratio $i_{nom}$	Exact Ratio $i_{exact}$	Cantilever Force Gear Shaft End $F_{rperm}$ N (lb <sub>f</sub> )	Overload Factor $f_B$
<b>2.23 (2.99)</b>	782	27.2 (20.1)	50 (36.9)	3.8	441/115	560 (125.9)	1.2
	511	41.6 (30.7)	102 (75.2)	5.9	47/8	917 (206.2)	1.6
<b>2.22 (2.98)</b>	289	73.5 (54.2)	138 (101.8)	10.5	841/81	1109 (249.3)	1.2
	196	108 (79.7)	230 (169.6)	15.5	703/46	1775 (399)	1.4
	128	166 (122.4)	350 (258.2)	23	845/36	3045 (684.5)	1.4
	86	247 (182.2)	550 (405.7)	35	975/28	5961 (1340.1)	1.5
<b>2.23 (2.99)</b>	60	355 (261.8)	600 (442.6)	50	1305/26	6734 (1513.9)	1.1
	43	495 (365.1)	850 (627)	70	10075/144	9229 (2074.8)	1.1
<b>2.07 (2.77)</b>	773	25.6 (18.9)	101 (74.5)	3.9	1363/351	799 (179.6)	3.3
<b>2.08 (2.79)</b>	511	38.8 (28.6)	115 (84.8)	5.9	47/8	917 (206.2)	2.5
<b>2.07 (2.77)</b>	289	68.5 (50.5)	138 (101.8)	10.5	847/81	1109 (249.3)	1.7
	196	101 (74.5)	230 (169.4)	15.5	703/46	1775 (399)	1.9
<b>2.08 (2.79)</b>	191	104 (76.7)	138 (101.8)	15.5	377/24	1273 (286.2)	1.1
	128	155 (114.3)	350 (258.2)	23	845/36	3045 (684.5)	1.9
<b>2.07 (2.77)</b>	127	156 (115.1)	230 (169.4)	24	637/27	2051 (461.1)	1.3
	86	230 (169.6)	550 (405.7)	35	975/28	5961 (1340.1)	2.0
<b>2.08 (2.79)</b>	86	231 (170.4)	350 (258.2)	35	1261/36	3479 (782.1)	1.3
<b>2.07 (2.77)</b>	60	329 (242.7)	920 (678.6)	50	1943/39	8241 (1852.7)	2.4
<b>2.09 (2.8)</b>	44	454 (334.9)	1380 (1017.9)	69	620/9	12344 (2775.1)	2.6
<b>3.20 (4.29)</b>	773	39.5 (29.1)	101 (74.5)	3.9	1363/351	799 (179.6)	1.7
	772	39.6 (29.2)	154 (113.6)	3.9	486/125	1125 (252.9)	2.5
	511	59.8 (44.1)	115 (84.8)	5.9	47/8	917 (206.2)	1.3
	518	59 (43.5)	176 (129.8)	5.8	666/115	1284 (288.7)	2.0
	320	95.6 (70.5)	230 (169.6)	9.4	2450/261	1509 (339.2)	1.6
	322	94.8 (69.9)	350 (258.2)	9.3	3575/384	2237 (502.9)	2.4
<b>3.19 (4.28)</b>	193	158 (116.5)	400 (295)	15.5	544/35	2654 (596.6)	1.7
<b>3.18 (4.26)</b>	190	160 (118)	600 (442.6)	16	63/4	4576 (1028.7)	2.5
<b>3.19 (4.28)</b>	128	238 (175.5)	550 (405.7)	23	1495/64	5219 (1173.3)	1.5
	128	238 (175.5)	850 (627)	23	1495/64	6402 (1439.2)	2.3
<b>3.20 (4.29)</b>	86	355 (261.8)	550 (405.7)	35	975/28	5961 (1340.1)	1.0
	86	355 (261.8)	1380 (1017.9)	35	1360/39	9838 (2211.7)	2.6
<b>3.19 (4.28)</b>	60	507 (374)	920 (678.6)	50	1943/39	2265 (509.2)	1.2
<b>3.20 (4.29)</b>	64	477 (351.8)	1971 (1453.8)	47	515/11	14923 (3354.8)	2.7
<b>3.23 (4.33)</b>	44	702 (517.8)	1380 (1017.9)	69	620/9	12344 (2775.1)	1.3
<b>3.19 (4.28)</b>	43	708 (522.2)	2300 (1696.5)	70	765/11	17027 (3827.8)	2.1
<b>3.66 (4.91)</b>	774	45.1 (33.3)	251 (185.1)	3.9	190/49	1671 (375.7)	3.7
	512	68.2 (50.3)	288 (212.4)	5.9	2584/441	1917 (431)	2.8
<b>3.64 (4.88)</b>	322	108 (79.7)	350 (258.2)	9.3	3575/384	2237 (502.9)	2.2
<b>3.66 (4.91)</b>	193	181 (133.5)	400 (295)	15.5	544/35	2654 (596.6)	1.5
<b>3.64 (4.88)</b>	190	183 (135)	600 (442.6)	16	63/4	4576 (1028.7)	2.2
<b>3.65 (4.89)</b>	128	272 (200.6)	850 (627)	23	1495/64	6402 (1439.2)	2.1
	128	272 (200.6)	550 (405.7)	23	1495/64	5219 (1173.3)	1.3
<b>3.66 (4.91)</b>	86	406 (299.5)	1380 (1017.9)	35	1360/39	9838 (2211.7)	2.3
<b>3.65 (4.89)</b>	66	528 (389.5)	1380 (1017.9)	45	136/3	1852 (416.3)	1.7
	64	545 (402)	2300 (1696.5)	47	515/11	14923 (3354.8)	2.8
<b>3.70 (4.96)</b>	44	802 (591.6)	4140 (3053.7)	69	6209	23146 (5203.5)	3.4

# Servo Motors for SIMOVERT MASTERDRIVES

## Synchronous Servo Motors

### 1FK7 Geared Servo Motors Helical Geared Motors

	Gear Size	Motor Type	Helical Geared Motors			Approx. Total Weight kg (lb)	
			Order No.	Order codes	Order codes		
		SH		Gearbox Type	Type of Construction	Mounting Position Type	
	C002	63	1FK7063 – 5AF71 – 1 ■ ■ ■ 5 – Z	D01	G ■ ■	H ■ ■	17.1 (37.7)
	C102	63	1FK7063 – 5AF71 – 1 ■ ■ ■ 5 – Z	D12	G ■ ■	H ■ ■	22 (48.5)
	C102	63	1FK7063 – 5AF71 – 1 ■ ■ ■ 5 – Z	D13	G ■ ■	H ■ ■	22 (48.5)
	C202	63	1FK7063 – 5AF71 – 1 ■ ■ ■ 5 – Z	D24	G ■ ■	H ■ ■	26 (57.3)
	C302	63	1FK7063 – 5AF71 – 1 ■ ■ ■ 5 – Z	D35	G ■ ■	H ■ ■	31.1 (68.6)
	C402	63	1FK7063 – 5AF71 – 1 ■ ■ ■ 5 – Z	D46	G ■ ■	H ■ ■	41.3 (91.1)
	C402	63	1FK7063 – 5AF71 – 1 ■ ■ ■ 5 – Z	D47	G ■ ■	H ■ ■	41.3 (91.1)
	C502	63	1FK7063 – 5AF71 – 1 ■ ■ ■ 5 – Z	D58	G ■ ■	H ■ ■	52.9 (116.6)
	C102	80	1FK7080 – 5AF71 – 1 ■ ■ ■ 5 – Z	D11	G ■ ■	H ■ ■	21.7 (47.8)
	C102	80	1FK7080 – 5AF71 – 1 ■ ■ ■ 5 – Z	D12	G ■ ■	H ■ ■	21.7 (47.8)
	C102	80	1FK7080 – 5AF71 – 1 ■ ■ ■ 5 – Z	D13	G ■ ■	H ■ ■	21.7 (47.8)
	C202	80	1FK7080 – 5AF71 – 1 ■ ■ ■ 5 – Z	D24	G ■ ■	H ■ ■	25.7 (56.7)
	C102	80	1FK7080 – 5AF71 – 1 ■ ■ ■ 5 – Z	D14	G ■ ■	H ■ ■	21.7 (47.8)
	C302	80	1FK7080 – 5AF71 – 1 ■ ■ ■ 5 – Z	D35	G ■ ■	H ■ ■	30.8 (67.9)
	C202	80	1FK7080 – 5AF71 – 1 ■ ■ ■ 5 – Z	D25	G ■ ■	H ■ ■	25.7 (56.7)
	C402	80	1FK7080 – 5AF71 – 1 ■ ■ ■ 5 – Z	D46	G ■ ■	H ■ ■	41 (90.4)
	C302	80	1FK7080 – 5AF71 – 1 ■ ■ ■ 5 – Z	D36	G ■ ■	H ■ ■	30.8 (67.9)
	C502	80	1FK7080 – 5AF71 – 1 ■ ■ ■ 5 – Z	D57	G ■ ■	H ■ ■	52.6 (116)
	C612	80	1FK7080 – 5AF71 – 1 ■ ■ ■ 5 – Z	D68	G ■ ■	H ■ ■	67.9 (149.7)
	C102	80	1FK7083 – 5AF71 – 1 ■ ■ ■ 5 – Z	D11	G ■ ■	H ■ ■	26.9 (59.3)
	C202	80	1FK7083 – 5AF71 – 1 ■ ■ ■ 5 – Z	D21	G ■ ■	H ■ ■	30.9 (68.1)
	C102	80	1FK7083 – 5AF71 – 1 ■ ■ ■ 5 – Z	D12	G ■ ■	H ■ ■	26.9 (59.3)
	C202	80	1FK7083 – 5AF71 – 1 ■ ■ ■ 5 – Z	D22	G ■ ■	H ■ ■	30.9 (68.1)
	C202	80	1FK7083 – 5AF71 – 1 ■ ■ ■ 5 – Z	D23	G ■ ■	H ■ ■	30.9 (68.1)
	C302	80	1FK7083 – 5AF71 – 1 ■ ■ ■ 5 – Z	D33	G ■ ■	H ■ ■	36 (79.4)
	C302	80	1FK7083 – 5AF71 – 1 ■ ■ ■ 5 – Z	D34	G ■ ■	H ■ ■	36 (79.4)
	C402	80	1FK7083 – 5AF71 – 1 ■ ■ ■ 5 – Z	D44	G ■ ■	H ■ ■	46.2 (101.9)
	C402	80	1FK7083 – 5AF71 – 1 ■ ■ ■ 5 – Z	D45	G ■ ■	H ■ ■	46.2 (101.9)
	C502	80	1FK7083 – 5AF71 – 1 ■ ■ ■ 5 – Z	D55	G ■ ■	H ■ ■	57.8 (127.5)
	C402	80	1FK7083 – 5AF71 – 1 ■ ■ ■ 5 – Z	D46	G ■ ■	H ■ ■	46.2 (101.9)
	C612	80	1FK7083 – 5AF71 – 1 ■ ■ ■ 5 – Z	D66	G ■ ■	H ■ ■	73.1 (161.2)
	C502	80	1FK7083 – 5AF71 – 1 ■ ■ ■ 5 – Z	D57	G ■ ■	H ■ ■	57.8 (127.5)
	C712	80	1FK7083 – 5AF71 – 1 ■ ■ ■ 5 – Z	D77	G ■ ■	H ■ ■	108.4 (239)
	C612	80	1FK7083 – 5AF71 – 1 ■ ■ ■ 5 – Z	D68	G ■ ■	H ■ ■	73.1 (161.2)
	C712	80	1FK7083 – 5AF71 – 1 ■ ■ ■ 5 – Z	D78	G ■ ■	H ■ ■	108.4 (239)
	C302	100	1FK7100 – 5AF71 – 1 ■ ■ ■ 5 – Z	D31	G ■ ■	H ■ ■	38.2 (84.2)
	C302	100	1FK7100 – 5AF71 – 1 ■ ■ ■ 5 – Z	D32	G ■ ■	H ■ ■	38.2 (84.2)
	C302	100	1FK7100 – 5AF71 – 1 ■ ■ ■ 5 – Z	D33	G ■ ■	H ■ ■	38.2 (84.2)
	C302	100	1FK7100 – 5AF71 – 1 ■ ■ ■ 5 – Z	D34	G ■ ■	H ■ ■	38.2 (84.2)
	C402	100	1FK7100 – 5AF71 – 1 ■ ■ ■ 5 – Z	D44	G ■ ■	H ■ ■	48.4 (106.7)
	C502	100	1FK7100 – 5AF71 – 1 ■ ■ ■ 5 – Z	D55	G ■ ■	H ■ ■	60 (132.3)
	C402	100	1FK7100 – 5AF71 – 1 ■ ■ ■ 5 – Z	D45	G ■ ■	H ■ ■	48.4 (106.7)
	C612	100	1FK7100 – 5AF71 – 1 ■ ■ ■ 5 – Z	D66	G ■ ■	H ■ ■	75.3 (166)
	C612	100	1FK7100 – 5AF71 – 1 ■ ■ ■ 5 – Z	D67	G ■ ■	H ■ ■	75.3 (166)
	C712	100	1FK7100 – 5AF71 – 1 ■ ■ ■ 5 – Z	D77	G ■ ■	H ■ ■	110.6 (243.8)
	C812	100	1FK7100 – 5AF71 – 1 ■ ■ ■ 5 – Z	D88	G ■ ■	H ■ ■	170.2 (375.3)
• Encoder system in motor:		Incremental encoder sin/cos 1 V <sub>pp</sub> Absolute encoder EnDat 2,048 pulses/revolution (shaft height 48 and higher) Simple absolute encoder EnDat 32 pulses/revolution (shaft height 48 and higher) Resolver, multipole (pole number = pole number for motor) Resolver, 2-pole	A E G S T				
• Holding brake:		Motor <b>without</b> holding brake Motor <b>with</b> holding brake	U V				

For order codes for type of construction, design, and mounting position, see page 4/32

# Servo Motors for SIMOVERT MASTERDRIVES

## Synchronous Servo Motors

1FK7 Geared Servo Motors  
Helical Geared Motors

### Selection and Ordering Data

Output (S3 60%) $P_2$ kW (HP)	Output Speed $n_2$ rpm	Rated Output Torque $M_2$ Nm (lb <sub>f</sub> -ft)	Max. Permiss. Acceleration Torque $M_{2max}$ Nm (lb <sub>f</sub> -ft)	Nominal Ratio $i_{nom}$	Exact Ratio $i_{exact}$	Cantilever Force Gear Shaft End $F_{rperm}$ N (lb <sub>f</sub> )	Overload Factor $f_B$
<b>4.73 (6.34)</b>	774	58.3 (43)	251 (185.1)	3.9	190/49	1671 (375.7)	2.5
<b>4.72 (6.33)</b>	512	88.1 (65)	288 (212.4)	5.9	2584/441	1917 (431)	1.9
	324	139 (102.5)	550 (405.7)	9.3	3445/372	3834 (862)	2.3
	322	140 (103.3)	350 (258.2)	9.3	3575/384	2237 (502.9)	1.4
	191	236 (174.1)	920 (678.6)	15.5	377/24	5609 (1261)	2.2
	190	237 (174.8)	600 (442.6)	16	63/4	4576 (1028.7)	1.5
<b>4.70 (6.3)</b>	128	351 (258.9)	850 (627)	23	1495/64	6402 (1439.2)	1.4
<b>4.71 (6.31)</b>	120	375 (276.6)	1650 (1217)	25	5185/208	8797 (1977.6)	2.5
<b>4.75 (6.37)</b>	86	527 (388.7)	2300 (1696.5)	35	2700/77	13552 (3046.6)	2.5
<b>4.71 (6.31)</b>	66	682 (503)	1380 (1017.9)	45	136/3	10737 (2413.8)	1.2
<b>4.72 (6.33)</b>	64	704 (519.3)	2300 (1696.5)	47	515/11	14923 (3354.8)	1.9
<b>4.77 (6.39)</b>	44	1036 (764.2)	4140 (3053.7)	69	620/6	23146 (5203.4)	2.3
<b>5.19 (6.96)</b>	644	77 (56.8)	251 (185.1)	3.9	190/49	1671 (375.7)	1.9
<b>5.18 (6.94)</b>	423	117 (86.3)	288 (212.4)	5.9	2584/441	1917 (431)	2.0
<b>5.19 (6.96)</b>	424	117 (86.3)	420 (309.8)	5.9	377/64	3297 (741.1)	1.4
<b>5.18 (6.94)</b>	269	184 (135.7)	350 (258.2)	9.3	3575/384	2237 (502.9)	2.5
<b>5.20 (6.97)</b>	241	206 (151.9)	920 (678.2)	10.5	841/81	4886 (1098.4)	1.1
<b>5.21 (6.98)</b>	159	313 (230.9)	600 (442.6)	16	63/4	4576 (1028.7)	1.1
<b>5.19 (6.96)</b>	154	322 (237.5)	1650 (1217)	16	1037/64	7620 (1713)	2.9
<b>5.20 (6.97)</b>	107	464 (342.2)	850 (627)	23	1495/64	6402 (1439.2)	1.9
<b>5.19 (6.96)</b>	100	496 (365.8)	1650 (1217)	25	5185/208	8797 (1977.6)	1.1
<b>5.23 (7.01)</b>	72	694 (511.9)	1380 (1017.9)	35	1360/39	9838 (2211.7)	3.4
	71	703 (518.5)	4140 (3053.7)	35	106/3	18528 (4165.3)	1.1
<b>5.17 (6.93)</b>	53	931 (686.7)	2300 (1696.5)	47	515/11	14923 (3354.8)	2.2
<b>5.18 (6.94)</b>	46	1076 (793.7)	4140 (3053.7)	54	704/13	21362 (4802.4)	1.2
<b>5.16 (6.92)</b>	36	1370 (1010.5)	4140 (3053.7)	69	620/9	23146 (5203.4)	1.1
<b>7.92 (10.62)</b>	770	98.2 (72.4)	366 (270)	4.7	841/216	2872 (645.7)	2.0
<b>7.93 (10.63)</b>	774	97.8 (72.1)	251 (185.1)	3.9	190/49	1671 (375.7)	1.4
<b>7.95 (10.66)</b>	513	148 (109.2)	650 (479.4)	5.9	117/20	4036 (907.3)	2.4
<b>7.91 (10.6)</b>	475	159 (117.3)	296 (218.3)	6.3	221/35	1965 (441.7)	1.0
<b>7.94 (10.64)</b>	324	234 (172.6)	850 (627)	9.3	3445/372	4703 (1057.2)	2.0
	324	234 (172.6)	550 (405.7)	9.3	3445/372	3834 (862)	1.3
<b>7.92 (10.62)</b>	191	396 (292.1)	920 (678.6)	16	377/24	5609 (1261)	1.3
	185	409 (301.7)	1650 (1217)	16	1037/64	7620 (1713)	2.2
<b>7.90 (10.59)</b>	129	585 (431.5)	2300 (1696.5)	23	255/11	11806 (2654)	2.1
	120	629 (464)	1650 (1217)	25	5185/208	8797 (1997.6)	1.4
<b>7.93 (10.63)</b>	85	891 (657.2)	4140 (3053.7)	36	106/3	18528 (4165.2)	2.5
<b>7.96 (10.67)</b>	86	884 (652)	2300 (1696.5)	35	2700/77	13552 (3046.1)	1.4
<b>7.93 (10.63)</b>	66	1148 (846.8)	4140 (3053.7)	46	592/13	20163 (4532.8)	2.0
<b>7.91 (10.6)</b>	64	1181 (871.1)	2300 (1696.5)	47	515/11	14923 (3354.8)	1.1
<b>8.00 (10.72)</b>	44	1737 (1281.2)	4140 (3053.7)	69	620/9	23146 (5203.5)	1.3



# Servo Motors for SIMOVERT MASTERDRIVES

## Synchronous Servo Motors

### 1FK7 Geared Servo Motors Helical Geared Motors

Gear Size	Motor Type	SH	Helical Geared Motors			Approx. Total Weight kg (lb)	
			Order No.	Order codes	Order codes		
				Gearbox Type	Type of Construction	Mounting Position Type	
C302	100		1FK7101 – 5AF71 – 1 ■ ■ 5 – Z	D31	G ■ ■	H ■ ■	43.8 (96.6)
C302	100		1FK7101 – 5AF71 – 1 ■ ■ 5 – Z	D32	G ■ ■	H ■ ■	43.8 (96.6)
C402	100		1FK7101 – 5AF71 – 1 ■ ■ 5 – Z	D43	G ■ ■	H ■ ■	43.8 (96.6)
C302	100		1FK7101 – 5AF71 – 1 ■ ■ 5 – Z	D33	G ■ ■	H ■ ■	54 (119.1)
C502	100		1FK7101 – 5AF71 – 1 ■ ■ 5 – Z	D54	G ■ ■	H ■ ■	65.6 (144.7)
C402	100		1FK7101 – 5AF71 – 1 ■ ■ 5 – Z	D44	G ■ ■	H ■ ■	54 (119.1)
C502	100		1FK7101 – 5AF71 – 1 ■ ■ 5 – Z	D55	G ■ ■	H ■ ■	65.6 (144.7)
C612	100		1FK7101 – 5AF71 – 1 ■ ■ 5 – Z	D65	G ■ ■	H ■ ■	80.9 (178.4)
C712	100		1FK7101 – 5AF71 – 1 ■ ■ 5 – Z	D76	G ■ ■	H ■ ■	116.2 (256.2)
C612	100		1FK7101 – 5AF71 – 1 ■ ■ 5 – Z	D67	G ■ ■	H ■ ■	80.9 (178.4)
C712	100		1FK7101 – 5AF71 – 1 ■ ■ 5 – Z	D77	G ■ ■	H ■ ■	116.2 (256.2)
C812	100		1FK7101 – 5AF71 – 1 ■ ■ 5 – Z	D88	G ■ ■	H ■ ■	175.8 (387.2)
C302	100		1FK7103 – 5AF71 – 1 ■ ■ 5 – Z	D31	G ■ ■	H ■ ■	50.4 (111.1)
C302	100		1FK7103 – 5AF71 – 1 ■ ■ 5 – Z	D32	G ■ ■	H ■ ■	50.4 (111.1)
C402	100		1FK7103 – 5AF71 – 1 ■ ■ 5 – Z	D42	G ■ ■	H ■ ■	60.6 (133.6)
C302	100		1FK7103 – 5AF71 – 1 ■ ■ 5 – Z	D33	G ■ ■	H ■ ■	50.4 (111.1)
C502	100		1FK7103 – 5AF71 – 1 ■ ■ 5 – Z	D53	G ■ ■	H ■ ■	72.2 (159.2)
C402	100		1FK7103 – 5AF71 – 1 ■ ■ 5 – Z	D44	G ■ ■	H ■ ■	60.6 (133.6)
C612	100		1FK7103 – 5AF71 – 1 ■ ■ 5 – Z	D64	G ■ ■	H ■ ■	87.5 (192.3)
C502	100		1FK7103 – 5AF71 – 1 ■ ■ 5 – Z	D55	G ■ ■	H ■ ■	72.2 (159.2)
C612	100		1FK7103 – 5AF71 – 1 ■ ■ 5 – Z	D65	G ■ ■	H ■ ■	87.5 (192.3)
C612	100		1FK7103 – 5AF71 – 1 ■ ■ 5 – Z	D66	G ■ ■	H ■ ■	87.5 (192.3)
C812	100		1FK7103 – 5AF71 – 1 ■ ■ 5 – Z	D86	G ■ ■	H ■ ■	182.4 (402.2)
C712	100		1FK7103 – 5AF71 – 1 ■ ■ 5 – Z	D77	G ■ ■	H ■ ■	122.8 (270.8)
C812	100		1FK7103 – 5AF71 – 1 ■ ■ 5 – Z	D87	G ■ ■	H ■ ■	182.4 (402.2)
C812	100		1FK7103 – 5AF71 – 1 ■ ■ 5 – Z	D88	G ■ ■	H ■ ■	182.4 (402.2)
C402	100		1FK7105 – 5AF71 – 1 ■ ■ 5 – Z	D41	G ■ ■	H ■ ■	70.6 (155.7)
C302	100		1FK7105 – 5AF71 – 1 ■ ■ 5 – Z	D31	G ■ ■	H ■ ■	60.4 (133.2)
C502	100		1FK7105 – 5AF71 – 1 ■ ■ 5 – Z	D52	G ■ ■	H ■ ■	82.2 (181.3)
C302	100		1FK7105 – 5AF71 – 1 ■ ■ 5 – Z	D32	G ■ ■	H ■ ■	60.4 (133.2)
C502	100		1FK7105 – 5AF71 – 1 ■ ■ 5 – Z	D53	G ■ ■	H ■ ■	82.2 (181.3)
C402	100		1FK7105 – 5AF71 – 1 ■ ■ 5 – Z	D43	G ■ ■	H ■ ■	70.6 (155.7)
C502	100		1FK7105 – 5AF71 – 1 ■ ■ 5 – Z	D54	G ■ ■	H ■ ■	82.2 (181.3)
C612	100		1FK7105 – 5AF71 – 1 ■ ■ 5 – Z	D64	G ■ ■	H ■ ■	97.5 (215)
C712	100		1FK7105 – 5AF71 – 1 ■ ■ 5 – Z	D75	G ■ ■	H ■ ■	132.8 (292.8)
C612	100		1FK7105 – 5AF71 – 1 ■ ■ 5 – Z	D65	G ■ ■	H ■ ■	97.5 (215)
C812	100		1FK7105 – 5AF71 – 1 ■ ■ 5 – Z	D86	G ■ ■	H ■ ■	192.4 (424.2)
C712	100		1FK7105 – 5AF71 – 1 ■ ■ 5 – Z	D76	G ■ ■	H ■ ■	132.8 (292.8)
C812	100		1FK7105 – 5AF71 – 1 ■ ■ 5 – Z	D87	G ■ ■	H ■ ■	192.4 (424.2)
C712	100		1FK7105 – 5AF71 – 1 ■ ■ 5 – Z	D77	G ■ ■	H ■ ■	132.8 (292.8)
C812	100		1FK7105 – 5AF71 – 1 ■ ■ 5 – Z	D88	G ■ ■	H ■ ■	192.4 (424.2)
Encoder system in motor:	Incremental encoder sin/cos 1 V <sub>pp</sub> Absolute encoder EnDat 2,048 pulses/revolution (shaft height 48 and higher) Simple absolute encoder EnDat 32 pulses/revolution (shaft height 48 and higher) Resolver, multipole (pole number = pole number for motor) Resolver, 2-pole		A E G S T				
Holding brake:	Motor <b>without</b> holding brake Motor <b>with</b> holding brake		U V				

For order codes for type of construction, design, and mounting position, see page 4/32



# Servo Motors for SIMOVERT MASTERDRIVES

## Synchronous Servo Motors

### 1FK7 Geared Servo Motors Offset Shaft Geared Motors

#### Selection and Ordering Data

Output (S3 60%) $P_2$ kW (HP)	Output Speed $n_2$ rpm	Rated Output Torque $M_2$ Nm (lb <sub>f</sub> -ft)	Max. Permiss. Acceleration Torque $M_{2max}$ Nm (lb <sub>f</sub> -ft)	Nominal Ratio $i_{nom}$	Exact Ratio $i_{exact}$	Cantilever Force Gear Shaft End $F_{rperm}$ N (lb <sub>f</sub> )	Overload Factor $f_B$
<b>0.30 (0.4)</b>	696 464	4.07 (3) 6.11 (4.5)	24 (17.7) 33 (24.3)	4.3 6.5	56/13 84/13	1021 (229.5) 1169 (262.8)	4.7 4.5
	275 221	10.3 (7.6) 12.9 (9.5)	52 (38.4) 62 (45.7)	11 13.5	273/25 231/17	1392 (312.9) 1497 (336.5)	4.1 3.9
	130 86	21.8 (16.1) 33.1 (24.4)	114 (84.1) 120 (88.5)	23 35	3185/138 3575/102	1786 (401.5) 2053 (461.5)	4.2 2.9
<b>0.41 (0.55)</b>	696 464	5.64 (4.2) 8.46 (6.2)	45 (33.2) 64 (47.2)	4.3 6.5	56/13 84/13	1021 (229.5) 1169 (262.8)	6.7 6.3
	275 221	14.3 (10.5) 17.8 (13.1)	99 (73) 105 (77.4)	11 13.5	273/25 231/17	1392 (312.9) 1497 (336.5)	5.8 5.0
	130 86	30.2 (22.3) 45.9 (33.9)	120 (88.5) 120 (88.5)	23 35	3185/138 3575/102	1786 (401.5) 2053 (461.5)	3.4 2.2
<b>0.79 (1.06)</b>	696 464	10.9 (8) 16.3 (12)	45 (33.2) 64 (47.2)	4.3 6.5	56/13 84/13	1021 (229.5) 1169 (262.8)	3.6 3.4
	275 221	27.5 (20.3) 34.3 (25.3)	99 (73) 105 (77.4)	11 13.5	273/25 231/17	1392 (312.9) 1497 (336.5)	3.1 2.7
	130 128	58.2 (42.9) 59.1 (43.6)	120 (88.5) 233 (171.9)	23 23	3185/138 2320/99	1786 (401.5) 2308 (518.8)	1.8 3.4
	86 85	88.4 (65.2) 89.4 (65.9)	120 (88.5) 270 (171.9)	35 35	3575/102 390/11	2053 (461.5) 2650 (595.7)	1.2 2.6
	696 464	19.6 (14.5) 29.5 (21.8)	80 (59) 91 (67.1)	4.3 6.5	56/13 84/13	1021 (229.5) 1169 (262.8)	3.2 2.4
<b>1.43 (1.92)</b>	275 278	49.8 (36.7) 49.3 (36.4)	105 (77.4) 196 (144.6)	11 11	273/25 7303/676	1392 (312.9) 1783 (595.7)	1.7 3.1
	221 220	61.9 (45.7) 62.1 (45.8)	105 (77.4) 210 (154.9)	13.5 13.5	231/17 109/8	1497 (336.5) 1927 (433.2)	1.3 2.6
	128 85 86	107 (78.9) 162 (119.5) 160 (118)	270 (199.2) 270 (199.2) 450 (331.9)	23 35 35	2320/99 390/11 7252/207	2308 (518.9) 2650 (595.7) 3666 (824.1)	2.0 1.3 2.2
	696 464	30.5 (22.5) 45.8 (33.8)	80 (59) 91 (67.1)	4.3 6.5	56/13 84/13	1021 (229.5) 1169 (269.8)	1.7 1.3
	540 278	39.3 (29) 76.5 (56.4)	112 (82.6) 196 (144.6)	5.6 11	5341/962 7303/676	1428 (321) 1783 (400.8)	1.9 1.7
<b>2.22 (2.98)</b>	220 128 86	96.5 (71.2) 166 (122.4) 248 (182.9)	210 (154.9) 270 (199.2) 450 (331.9)	13.5 23 35	109/8 2320/99 7252/207	1927 (433.2) 2308 (518.9) 3666 (824.1)	1.4 1.1 1.2

# Servo Motors for SIMOVERT MASTERDRIVES

## Synchronous Servo Motors

1FK7 Geared Servo Motors  
Offset Shaft Geared Motors

Gear Size	Motor Type	SH	Offset Shaft Geared Motors		Order codes			Approx. Total Weight kg (lb)
			Order No.		Gearbox Type	Type of Construction	Mounting Position Type	
F102	36	36	1FK7032 - 5AK71 - 1 ■ ■ 5 - Z		C11	G ■ ■	H ■ ■	13.8 (30.4)
F102	36	36	1FK7032 - 5AK71 - 1 ■ ■ 5 - Z		C12	G ■ ■	H ■ ■	13.8 (30.4)
F102	36	36	1FK7032 - 5AK71 - 1 ■ ■ 5 - Z		C13	G ■ ■	H ■ ■	13.8 (30.4)
F102	36	36	1FK7032 - 5AK71 - 1 ■ ■ 5 - Z		C14	G ■ ■	H ■ ■	13.8 (30.4)
F102	36	36	1FK7032 - 5AK71 - 1 ■ ■ 5 - Z		C15	G ■ ■	H ■ ■	13.8 (30.4)
F102	36	36	1FK7032 - 5AK71 - 1 ■ ■ 5 - Z		C16	G ■ ■	H ■ ■	13.8 (30.4)
F102	48	48	1FK7040 - 5AK71 - 1 ■ ■ 5 - Z		C11	G ■ ■	H ■ ■	14.6 (32.2)
F102	48	48	1FK7040 - 5AK71 - 1 ■ ■ 5 - Z		C12	G ■ ■	H ■ ■	14.6 (32.2)
F102	48	48	1FK7040 - 5AK71 - 1 ■ ■ 5 - Z		C13	G ■ ■	H ■ ■	14.6 (32.2)
F102	48	48	1FK7040 - 5AK71 - 1 ■ ■ 5 - Z		C14	G ■ ■	H ■ ■	14.6 (32.2)
F102	48	48	1FK7040 - 5AK71 - 1 ■ ■ 5 - Z		C15	G ■ ■	H ■ ■	14.6 (32.2)
F102	48	48	1FK7040 - 5AK71 - 1 ■ ■ 5 - Z		C16	G ■ ■	H ■ ■	14.6 (32.2)
F102	48	48	1FK7042 - 5AF71 - 1 ■ ■ 5 - Z		C11	G ■ ■	H ■ ■	15.9 (35.1)
F102	48	48	1FK7042 - 5AF71 - 1 ■ ■ 5 - Z		C12	G ■ ■	H ■ ■	15.9 (35.1)
F102	48	48	1FK7042 - 5AF71 - 1 ■ ■ 5 - Z		C13	G ■ ■	H ■ ■	15.9 (35.1)
F102	48	48	1FK7042 - 5AF71 - 1 ■ ■ 5 - Z		C14	G ■ ■	H ■ ■	15.9 (35.1)
F102	48	48	1FK7042 - 5AF71 - 1 ■ ■ 5 - Z		C15	G ■ ■	H ■ ■	15.9 (35.1)
F202	48	48	1FK7042 - 5AF71 - 1 ■ ■ 5 - Z		C25	G ■ ■	H ■ ■	24.1 (53.1)
F102	48	48	1FK7042 - 5AF71 - 1 ■ ■ 5 - Z		C16	G ■ ■	H ■ ■	15.9 (35.1)
F202	48	48	1FK7042 - 5AF71 - 1 ■ ■ 5 - Z		C26	G ■ ■	H ■ ■	53.1 (24.1)
F102	63	63	1FK7060 - 5AF71 - 1 ■ ■ 5 - Z		C11	G ■ ■	H ■ ■	18.6 (41)
F102	63	63	1FK7060 - 5AF71 - 1 ■ ■ 5 - Z		C12	G ■ ■	H ■ ■	18.6 (41)
F102	63	63	1FK7060 - 5AF71 - 1 ■ ■ 5 - Z		C13	G ■ ■	H ■ ■	18.6 (41)
F202	63	63	1FK7060 - 5AF71 - 1 ■ ■ 5 - Z		C23	G ■ ■	H ■ ■	26.8 (59.1)
F102	63	63	1FK7060 - 5AF71 - 1 ■ ■ 5 - Z		C14	G ■ ■	H ■ ■	18.6 (41)
F202	63	63	1FK7060 - 5AF71 - 1 ■ ■ 5 - Z		C24	G ■ ■	H ■ ■	26.8 (59.1)
F202	63	63	1FK7060 - 5AF71 - 1 ■ ■ 5 - Z		C25	G ■ ■	H ■ ■	26.8 (59.1)
F202	63	63	1FK7060 - 5AF71 - 1 ■ ■ 5 - Z		C26	G ■ ■	H ■ ■	26.8 (59.1)
F302	63	63	1FK7060 - 5AF71 - 1 ■ ■ 5 - Z		C36	G ■ ■	H ■ ■	34.4 (75.9)
F102	63	63	1FK7063 - 5AF71 - 1 ■ ■ 5 - Z		C11	G ■ ■	H ■ ■	22.3 (49.2)
F102	63	63	1FK7063 - 5AF71 - 1 ■ ■ 5 - Z		C12	G ■ ■	H ■ ■	22.3 (49.2)
F202	63	63	1FK7063 - 5AF71 - 1 ■ ■ 5 - Z		C22	G ■ ■	H ■ ■	30.5 (67.3)
F202	63	63	1FK7063 - 5AF71 - 1 ■ ■ 5 - Z		C23	G ■ ■	H ■ ■	30.5 (67.3)
F202	63	63	1FK7063 - 5AF71 - 1 ■ ■ 5 - Z		C24	G ■ ■	H ■ ■	30.5 (67.3)
F202	63	63	1FK7063 - 5AF71 - 1 ■ ■ 5 - Z		C25	G ■ ■	H ■ ■	30.5 (67.3)
F302	63	63	1FK7063 - 5AF71 - 1 ■ ■ 5 - Z		C36	G ■ ■	H ■ ■	38.1 (84)

- Encoder system in motor:
  - Incremental encoder sin/cos 1 V<sub>pp</sub>
  - Absolute encoder EnDat 2,048 pulses/revolution (shaft height 48 and higher)
  - Absolute encoder EnDat 512 pulses/revolution (shaft height 36 only)
  - Simple absolute encoder EnDat 32 pulses/revolution (shaft height 48 and higher)
  - Resolver, multipole (pole number = pole number for motor)
  - Resolver, 2-pole
- Holding brake:
  - Motor **without** holding brake
  - Motor **with** holding brake

For order codes for type of construction, design, and mounting position, see page 4/32

4

# Servo Motors for SIMOVERT MASTERDRIVES

## Synchronous Servo Motors

### 1FK7 Geared Servo Motors Offset Shaft Geared Motors

#### Selection and Ordering Data

Output (S3 60%) $P_2$ kW (HP)	Output Speed $n_2$ rpm	Rated Output Torque $M_2$ Nm (lb <sub>f</sub> -ft)	Max. Permiss. Acceleration Torque $M_{2max}$ Nm (lb <sub>f</sub> -ft)	Nominal Ratio $i_{nom}$	Exact Ratio $i_{exact}$	Cantilever Force Gear Shaft End $F_{rperm}$ N (lb <sub>f</sub> )	Overload Factor $f_B$	
<b>2.08 (2.79)</b>	540	36.6 (27)	173 (127.6)	5.6	5341/962	1428 (321)	4.0	
	278	71.3 (52.6)	210 (154.9)	11	7303/676	1783 (400.8)	2.5	
	220	89.9 (66.3)	210 (154.9)	13.5	109/8	1927 (433.2)	2.0	
	128	155 (114.3)	270 (199.2)	23	2320/99	2308 (518.9)	1.5	
<b>3.20 (4.29)</b>	128	155 (114.3)	450 (331.9)	24	588/25	3210 (721.6)	2.5	
	86	231 (170.4)	450 (331.9)	35	7252/207	3666 (824.1)	1.7	
	86	231 (170.4)	700 (516.3)	35	2210/63	4523 (1016.8)	2.6	
	540	56.5 (41.7)	173 (127.6)	5.6	5341/962	1428 (321)	2.0	
<b>3.20 (4.29)</b>	278	110 (81.1)	210 (154.9)	11	7303/676	1783 (400.8)	1.3	
	278	110 (81.1)	350 (258.2)	11	1456/135	2475 (556.4)	2.1	
	224	136 (100.3)	350 (258.2)	13.5	7696/575	2660 (598)	1.7	
	221	138 (101.8)	550 (405.7)	13.5	5984/441	3296 (741)	2.6	
<b>3.66 (4.91)</b>	128	240 (177)	450 (331.9)	24	588/25	3210 (721.6)	1.2	
	129	236 (174.1)	700 (516.3)	23	325/14	3942 (886.2)	1.9	
	86	357 (263.3)	700 (516.3)	35	2210/63	4523 (1016.8)	1.3	
	85	359 (264.8)	1100 (811.4)	35	845/24	6120 (1375.8)	2.0	
<b>3.66 (4.91)</b>	516	67.7 (49.9)	482 (355.5)	5.8	3784/651	2484 (558.4)	4.8	
	277	126 (92.9)	550 (405.7)	11	682/63	3057 (687.2)	2.9	
	221	158 (116.5)	550 (405.7)	13.5	5984/441	3296 (741)	2.3	
	129	270 (199.2)	700 (516.3)	23	325/14	3942 (886.2)	1.7	
<b>4.72 (6.33)</b>	129	271 (199.9)	1100 (811.4)	23	1885/81	5331 (1198.5)	2.7	
	86	408 (300.9)	700 (516.3)	35	2210/63	4523 (1016.8)	1.1	
	516	87.4 (64.5)	482 (355.5)	5.8	3784/651	2484 (558.4)	3.2	
	277	163 (120.2)	550 (405.7)	11	682/63	3057 (687.2)	1.9	
<b>4.72 (6.33)</b>	221	204 (150.5)	550 (405.7)	13.5	5984/441	3296 (741)	1.5	
	220	205 (151.2)	1100 (811.4)	13.5	871/64	4458 (1002.2)	2.8	
	129	349 (257.4)	700 (516.3)	23	325/14	3942 (886.2)	1.2	
	85	529 (390.2)	1100 (811.4)	35	845/24	6120 (1375.8)	1.2	
<b>5.20 (6.97)</b>	430	115 (84.8)	482 (355.5)	5.8	3784/651	2484 (558.4)	2.4	
	231	215 (158.6)	550 (405.7)	11	682/63	3057 (687.2)	1.5	
	231	215 (158.6)	991 (731)	11	2077/192	4130 (928.2)	2.6	
	184	269 (198.4)	550 (405.7)	13.5	5984/441	3296 (741)	1.2	
<b>5.20 (6.97)</b>	183	270 (199.2)	1000 (737.6)	13.5	871/64	4458 (1002.2)	2.1	
	108	460 (339.3)	1100 (811.4)	23	1885/81	5331 (1198.5)	1.4	
	7.93 (10.63)	529	143 (105.5)	766 (565)	5.7	1407/248	3330 (748.6)	2.9
	516	147 (108.4)	482 (355.5)	6	3784/651	2484 (558.4)	1.8	
<b>7.93 (10.63)</b>	277	273 (101.4)	991 (731)	11	2077/192	4130 (922.2)	2.0	
	277	273 (101.4)	550 (405.7)	11	682/63	3057 (687.2)	1.1	
	220	343 (253)	1000 (737.6)	13.6	871/64	4458 (1002.2)	1.6	
	129	587 (433)	1100 (811.4)	24	1885/81	5331 (1198.5)	1.0	

# Servo Motors for SIMOVERT MASTERDRIVES

## Synchronous Servo Motors

### 1FK7 Geared Servo Motors Offset Shaft Geared Motors

	Gear Size	Motor Type	Offset Shaft Geared Motors		Order codes			Approx. Total Weight kg (lb)
			Order No.		Gearbox Type	Type of Construction	Mounting Position Type	
	F202	80	1FK7080 – 5AF71 – 1	■ ■ ■ 5 – Z	C22	G ■ ■	H ■ ■	30.2 (66.6)
	F202	80	1FK7080 – 5AF71 – 1	■ ■ ■ 5 – Z	C23	G ■ ■	H ■ ■	30.2 (66.6)
	F202	80	1FK7080 – 5AF71 – 1	■ ■ ■ 5 – Z	C24	G ■ ■	H ■ ■	30.2 (66.6)
	F202	80	1FK7080 – 5AF71 – 1	■ ■ ■ 5 – Z	C25	G ■ ■	H ■ ■	30.2 (66.6)
	F302	80	1FK7080 – 5AF71 – 1	■ ■ ■ 5 – Z	C35	G ■ ■	H ■ ■	37.8 (83.4)
	F302	80	1FK7080 – 5AF71 – 1	■ ■ ■ 5 – Z	C36	G ■ ■	H ■ ■	37.8 (83.4)
	F402	80	1FK7080 – 5AF71 – 1	■ ■ ■ 5 – Z	C46	G ■ ■	H ■ ■	46.1 (101.7)
	F202	80	1FK7083 – 5AF71 – 1	■ ■ ■ 5 – Z	C22	G ■ ■	H ■ ■	35.4 (78.1)
	F202	80	1FK7083 – 5AF71 – 1	■ ■ ■ 5 – Z	C23	G ■ ■	H ■ ■	35.4 (78.1)
	F302	80	1FK7083 – 5AF71 – 1	■ ■ ■ 5 – Z	C33	G ■ ■	H ■ ■	43 (94.8)
	F302	80	1FK7083 – 5AF71 – 1	■ ■ ■ 5 – Z	C34	G ■ ■	H ■ ■	43 (94.8)
	F402	80	1FK7083 – 5AF71 – 1	■ ■ ■ 5 – Z	C44	G ■ ■	H ■ ■	51.3 (113.1)
	F302	80	1FK7083 – 5AF71 – 1	■ ■ ■ 5 – Z	C35	G ■ ■	H ■ ■	43 (94.8)
	F402	80	1FK7083 – 5AF71 – 1	■ ■ ■ 5 – Z	C45	G ■ ■	H ■ ■	51.3 (113.1)
	F402	80	1FK7083 – 5AF71 – 1	■ ■ ■ 5 – Z	C46	G ■ ■	H ■ ■	51.3 (113.1)
	F602	80	1FK7083 – 5AF71 – 1	■ ■ ■ 5 – Z	C66	G ■ ■	H ■ ■	78.3 (172.7)
	F402	100	1FK7100 – 5AF71 – 1	■ ■ ■ 5 – Z	C42	G ■ ■	H ■ ■	53.5 (118)
	F402	100	1FK7100 – 5AF71 – 1	■ ■ ■ 5 – Z	C43	G ■ ■	H ■ ■	53.5 (118)
	F402	100	1FK7100 – 5AF71 – 1	■ ■ ■ 5 – Z	C44	G ■ ■	H ■ ■	53.5 (118)
	F402	100	1FK7100 – 5AF71 – 1	■ ■ ■ 5 – Z	C45	G ■ ■	H ■ ■	53.5 (118)
	F602	100	1FK7100 – 5AF71 – 1	■ ■ ■ 5 – Z	C65	G ■ ■	H ■ ■	80.5 (177.5)
	F402	100	1FK7100 – 5AF71 – 1	■ ■ ■ 5 – Z	C46	G ■ ■	H ■ ■	53.5 (118)
	F402	100	1FK7101 – 5AF71 – 1	■ ■ ■ 5 – Z	C42	G ■ ■	H ■ ■	59.1 (130.3)
	F402	100	1FK7101 – 5AF71 – 1	■ ■ ■ 5 – Z	C43	G ■ ■	H ■ ■	59.1 (130.3)
	F402	100	1FK7101 – 5AF71 – 1	■ ■ ■ 5 – Z	C44	G ■ ■	H ■ ■	59.1 (130.3)
	F602	100	1FK7101 – 5AF71 – 1	■ ■ ■ 5 – Z	C64	G ■ ■	H ■ ■	86.1 (189.9)
	F402	100	1FK7101 – 5AF71 – 1	■ ■ ■ 5 – Z	C45	G ■ ■	H ■ ■	59.1 (130.3)
	F602	100	1FK7101 – 5AF71 – 1	■ ■ ■ 5 – Z	C66	G ■ ■	H ■ ■	86.1 (189.9)
	F402	100	1FK7103 – 5AF71 – 1	■ ■ ■ 5 – Z	C42	G ■ ■	H ■ ■	65.7 (144.9)
	F402	100	1FK7103 – 5AF71 – 1	■ ■ ■ 5 – Z	C43	G ■ ■	H ■ ■	65.7 (144.9)
	F602	100	1FK7103 – 5AF71 – 1	■ ■ ■ 5 – Z	C63	G ■ ■	H ■ ■	92.7 (204.4)
	F402	100	1FK7103 – 5AF71 – 1	■ ■ ■ 5 – Z	C44	G ■ ■	H ■ ■	65.7 (144.9)
	F602	100	1FK7103 – 5AF71 – 1	■ ■ ■ 5 – Z	C64	G ■ ■	H ■ ■	92.7 (204.4)
	F602	100	1FK7103 – 5AF71 – 1	■ ■ ■ 5 – Z	C65	G ■ ■	H ■ ■	92.7 (204.4)
	F602	100	1FK7105 – 5AF71 – 1	■ ■ ■ 5 – Z	C62	G ■ ■	H ■ ■	103 (227.1)
	F402	100	1FK7105 – 5AF71 – 1	■ ■ ■ 5 – Z	C42	G ■ ■	H ■ ■	75.7 (166.9)
	F602	100	1FK7105 – 5AF71 – 1	■ ■ ■ 5 – Z	C63	G ■ ■	H ■ ■	103 (227.1)
	F402	100	1FK7105 – 5AF71 – 1	■ ■ ■ 5 – Z	C43	G ■ ■	H ■ ■	75.7 (166.9)
	F602	100	1FK7105 – 5AF71 – 1	■ ■ ■ 5 – Z	C64	G ■ ■	H ■ ■	103 (227.1)
	F602	100	1FK7105 – 5AF71 – 1	■ ■ ■ 5 – Z	C65	G ■ ■	H ■ ■	103 (227.1)
• Encoder system in motor:	Incremental encoder sin/cos 1 V <sub>pp</sub> Absolute encoder EnDat 2,048 pulses/revolution (shaft height 48 and higher) Simple absolute encoder EnDat 32 pulses/revolution (shaft height 48 and higher) Resolver, multipole (pole number = pole number for motor) Resolver, 2-pole		A E G S T					
• Holding brake:	Motor <b>without</b> holding brake Motor <b>with</b> holding brake		U V					

For order codes for type of construction, design, and mounting position, see page 4/32

# Servo Motors for SIMOVERT MASTERDRIVES

## Synchronous Servo Motors

### 1FK7 Geared Servo Motors Bevel Geared Motors

#### Selection and Ordering Data

Output (S3 60%) $P_2$ kW (HP)	Output Speed $n_2$ rpm	Rated Output Torque $M_2$ Nm (lb <sub>f</sub> -ft)	Max. Permiss. Acceleration Torque $M_{2max}$ Nm (lb <sub>f</sub> -ft)	Nominal Ratio $i_{nom}$	Exact Ratio $i_{exact}$	Cantilever Force Gear Shaft End $F_{rperm}$ N (lb <sub>f</sub> )	Overload Factor $f_B$
<b>0.30 (0.4)</b>	750	3.78 (2.8)	22 (16.2)	4	4/1	1494 (335.9)	4.7
	500	5.68 (4.2)	31 (22.9)	6	6/1	1710 (384.4)	4.5
	296	9.59 (7.1)	48 (35.4)	10	507/50	2037 (457.9)	4.1
	179	15.8 (11.7)	73 (53.8)	16.5	117/7	2406 (540.9)	3.8
	129	22 (16.2)	102 (75.2)	23	1140/49	2686 (603.8)	3.8
85	33.2 (24.5)	135 (99.6)	35	3686/105	3081 (692.6)	3.3	
65	43.7 (32.2)	185 (136.5)	46	1849/40	4053 (911.2)	3.4	
43	65.7 (48.5)	159 (117.3)	69	6665/96	4641 (1043.3)	2.0	
<b>0.41 (0.55)</b>	750	5.24 (3.9)	42 (31)	4	4/1	1494 (335.9)	6.7
	500	7.86 (5.8)	59 (43.5)	6	6/1	1710 (384.2)	6.3
	296	13.3 (9.8)	92 (67.9)	10	507/50	2037 (457.9)	5.8
	179	21.9 (16.2)	122 (90)	16.5	117/7	2406 (540.9)	4.7
	129	30.5 (22.5)	135 (99.6)	23	1140/49	2686 (603.8)	3.7
85	46 (33.9)	135 (99.6)	35	3686/105	3081 (692.6)	2.5	
65	60.5 (44.6)	220 (162.3)	46	1849/40	4053 (911.2)	3.1	
<b>0.79 (1.06)</b>	750	10.1 (7.4)	42 (31)	4	4/1	1494 (335.9)	3.6
	500	15.1 (11.1)	59 (43.5)	6	6/1	1710 (384.2)	3.4
	296	25.6 (18.9)	92 (67.9)	10	507/50	2037 (457.9)	3.1
	179	42.2 (31.1)	122 (90)	16.5	117/7	2406 (540.9)	2.5
	129	58.7 (43.3)	135 (99.6)	23	1140/49	2686 (603.8)	2.0
85	88.5 (65.3)	135 (99.6)	35	3686/105	3081 (692.6)	1.3	
87	87.1 (64.2)	220 (162.3)	35	1935/56	3678 (826.4)	2.2	
<b>1.43 (1.92)</b>	750	18.2 (13.4)	76 (56.1)	4	4/1	1494 (335.9)	3.3
	500	27.4 (20.2)	87 (64.2)	6	6/1	1710 (384.4)	2.5
	296	46.2 (34.1)	103 (76)	10	507/50	2037 (457.9)	1.8
	178	76.9 (56.7)	219 (161.5)	17	2967/176	2895 (650.8)	2.2
	129	106 (78.2)	220 (162.3)	23	2967/128	3220 (723.9)	1.6
	129	106 (78.2)	385 (284)	23	559/24	3762 (845.7)	2.8
	87	158 (116.5)	220 (162.3)	35	1935/56	3678 (826.4)	1.1
	86	158 (116.5)	385 (284)	35	903/26	4298 (966.2)	1.9
<b>2.22 (2.98)</b>	65	211 (155.6)	385 (284)	46	1849/40	4728 (1062.9)	1.4
	65	211 (155.6)	600 (442.6)	46	602/13	7570 (1701.8)	2.2
	46	290 (213.9)	1000 (737.6)	65	12586/195	10154 (2282.7)	2.7
	750	28.3 (20.9)	76 (56.1)	4	4/1	1494 (335.9)	1.8
	750	28.3 (20.9)	83 (61.2)	4	4/1	1793 (403)	2.0
	500	42.5 (31.3)	87 (64.2)	6	6/1	1710 (384.2)	1.4
	500	42.5 (31.3)	128 (94.4)	6	6/1	2394 (538.2)	2.0
	324	65.6 (48.4)	186 (132.2)	9.3	1075/116	2767 (622)	1.9
178	119 (87.8)	219 (161.5)	17	2967/176	2895 (650.8)	1.2	
<b>2.17 (2.91)</b>	129	165 (121.7)	385 (284)	23	559/24	3762 (845.7)	1.5
	86	246 (181.4)	385 (284)	35	903/26	4298 (966.2)	1.0
	65	328 (241.9)	600 (442.6)	46	602/13	7570 (1701.8)	1.2
<b>2.17 (2.91)</b>	46	450 (331.9)	1000 (737.6)	65	12586/195	10154 (2282.7)	1.5

# Servo Motors for SIMOVERT MASTERDRIVES

## Synchronous Servo Motors

1FK7 Geared Servo Motors  
Bevel Geared Motors

	Gear Size	Motor Type	Bevel Geared Motors		Order codes			Approx. Total Weight kg (lb)
			Order No.		Gearbox Type	Type of Construction	Mounting Position Type	
		SH						
	K102	36	1FK7032 – 5AK71 – 1 ■ ■ 5 – Z		B11	G ■ ■	H ■ ■	12.3 (27.1)
	K102	36	1FK7032 – 5AK71 – 1 ■ ■ 5 – Z		B12	G ■ ■	H ■ ■	12.3 (27.1)
	K102	36	1FK7032 – 5AK71 – 1 ■ ■ 5 – Z		B13	G ■ ■	H ■ ■	12.3 (27.1)
	K102	36	1FK7032 – 5AK71 – 1 ■ ■ 5 – Z		B14	G ■ ■	H ■ ■	12.3 (27.1)
	K102	36	1FK7032 – 5AK71 – 1 ■ ■ 5 – Z		B15	G ■ ■	H ■ ■	12.3 (27.1)
	K102	36	1FK7032 – 5AK71 – 1 ■ ■ 5 – Z		B16	G ■ ■	H ■ ■	12.3 (27.1)
	K202	36	1FK7032 – 5AK71 – 1 ■ ■ 5 – Z		B27	G ■ ■	H ■ ■	19.8 (43.7)
	K202	36	1FK7032 – 5AK71 – 1 ■ ■ 5 – Z		B28	G ■ ■	H ■ ■	19.8 (43.7)
	K102	48	1FK7040 – 5AK71 – 1 ■ ■ 5 – Z		B11	G ■ ■	H ■ ■	13.1 (28.9)
	K102	48	1FK7040 – 5AK71 – 1 ■ ■ 5 – Z		B12	G ■ ■	H ■ ■	13.1 (28.9)
	K102	48	1FK7040 – 5AK71 – 1 ■ ■ 5 – Z		B13	G ■ ■	H ■ ■	13.1 (28.9)
	K102	48	1FK7040 – 5AK71 – 1 ■ ■ 5 – Z		B14	G ■ ■	H ■ ■	13.1 (28.9)
	K102	48	1FK7040 – 5AK71 – 1 ■ ■ 5 – Z		B15	G ■ ■	H ■ ■	13.1 (28.9)
	K102	48	1FK7040 – 5AK71 – 1 ■ ■ 5 – Z		B16	G ■ ■	H ■ ■	13.1 (28.9)
	K202	48	1FK7040 – 5AK71 – 1 ■ ■ 5 – Z		B27	G ■ ■	H ■ ■	20.6 (45.4)
	K102	48	1FK7042 – 5AF71 – 1 ■ ■ 5 – Z		B11	G ■ ■	H ■ ■	14.4 (31.8)
	K102	48	1FK7042 – 5AF71 – 1 ■ ■ 5 – Z		B12	G ■ ■	H ■ ■	14.4 (31.8)
	K102	48	1FK7042 – 5AF71 – 1 ■ ■ 5 – Z		B13	G ■ ■	H ■ ■	14.4 (31.8)
	K102	48	1FK7042 – 5AF71 – 1 ■ ■ 5 – Z		B14	G ■ ■	H ■ ■	14.4 (31.8)
	K102	48	1FK7042 – 5AF71 – 1 ■ ■ 5 – Z		B15	G ■ ■	H ■ ■	14.4 (31.8)
	K102	48	1FK7042 – 5AF71 – 1 ■ ■ 5 – Z		B17	G ■ ■	H ■ ■	14.4 (31.8)
	K202	48	1FK7042 – 5AF71 – 1 ■ ■ 5 – Z		B26	G ■ ■	H ■ ■	21.9 (48.3)
	K102	63	1FK7060 – 5AF71 – 1 ■ ■ 5 – Z		B11	G ■ ■	H ■ ■	17.1 (37.7)
	K102	63	1FK7060 – 5AF71 – 1 ■ ■ 5 – Z		B12	G ■ ■	H ■ ■	17.1 (37.7)
	K102	63	1FK7060 – 5AF71 – 1 ■ ■ 5 – Z		B13	G ■ ■	H ■ ■	17.1 (37.7)
	K202	63	1FK7060 – 5AF71 – 1 ■ ■ 5 – Z		B24	G ■ ■	H ■ ■	24.6 (54.2)
	K202	63	1FK7060 – 5AF71 – 1 ■ ■ 5 – Z		B25	G ■ ■	H ■ ■	24.6 (54.2)
	K302	63	1FK7060 – 5AF71 – 1 ■ ■ 5 – Z		B35	G ■ ■	H ■ ■	29.6 (65.3)
	K202	63	1FK7060 – 5AF71 – 1 ■ ■ 5 – Z		B26	G ■ ■	H ■ ■	24.6 (54.2)
	K302	63	1FK7060 – 5AF71 – 1 ■ ■ 5 – Z		B36	G ■ ■	H ■ ■	29.6 (65.3)
	K302	63	1FK7060 – 5AF71 – 1 ■ ■ 5 – Z		B37	G ■ ■	H ■ ■	29.6 (65.3)
	K402	63	1FK7060 – 5AF71 – 1 ■ ■ 5 – Z		B47	G ■ ■	H ■ ■	43.1 (95)
	K513	63	1FK7060 – 5AF71 – 1 ■ ■ 5 – Z		B58	G ■ ■	H ■ ■	48.9 (107.8)
	K102	63	1FK7063 – 5AF71 – 1 ■ ■ 5 – Z		B11	G ■ ■	H ■ ■	20.8 (45.9)
	K202	63	1FK7063 – 5AF71 – 1 ■ ■ 5 – Z		B21	G ■ ■	H ■ ■	28.3 (62.4)
	K102	63	1FK7063 – 5AF71 – 1 ■ ■ 5 – Z		B12	G ■ ■	H ■ ■	20.8 (45.9)
	K302	63	1FK7063 – 5AF71 – 1 ■ ■ 5 – Z		B32	G ■ ■	H ■ ■	33.3 (73.4)
	K302	63	1FK7063 – 5AF71 – 1 ■ ■ 5 – Z		B33	G ■ ■	H ■ ■	33.3 (73.4)
	K202	63	1FK7063 – 5AF71 – 1 ■ ■ 5 – Z		B24	G ■ ■	H ■ ■	28.3 (62.4)
	K302	63	1FK7063 – 5AF71 – 1 ■ ■ 5 – Z		B35	G ■ ■	H ■ ■	33.3 (73.4)
	K302	63	1FK7063 – 5AF71 – 1 ■ ■ 5 – Z		B36	G ■ ■	H ■ ■	33.3 (73.4)
	K402	63	1FK7063 – 5AF71 – 1 ■ ■ 5 – Z		B47	G ■ ■	H ■ ■	46.8 (103.2)
	K513	63	1FK7063 – 5AF71 – 1 ■ ■ 5 – Z		B58	G ■ ■	H ■ ■	52.6 (116)
• Encoder system in motor:	Incremental encoder sin/cos 1 V <sub>pp</sub> Absolute encoder EnDat 2,048 pulses/revolution (shaft height 48 and higher) Absolute encoder EnDat 512 pulses/revolution (shaft height 36 only) Simple absolute encoder EnDat 32 pulses/revolution (shaft height 48 and higher) Resolver, multipole (pole number = pole number for motor) Resolver, 2-pole		A E H G S T					
• Holding brake:	Motor <b>without</b> holding brake Motor <b>with</b> holding brake		U V					

For order codes for type of construction, design, and mounting position, see page 4/32

# Servo Motors for SIMOVERT MASTERDRIVES

## Synchronous Servo Motors

### 1FK7 Geared Servo Motors Bevel Geared Motors

#### Selection and Ordering Data

Output (S3 60%)	Output Speed	Rated Output Torque	Max. Permiss. Acceleration Torque	Nominal Ratio	Exact Ratio	Cantilever Force Gear Shaft End	Overload Factor
$P_2$ kW (HP)	$n_2$ rpm	$M_2$ Nm (lb <sub>f</sub> -ft)	$M_{2max}$ Nm (lb <sub>f</sub> -ft)	$i_{nom}$	$i_{exact}$	$F_{rperm}$ N (lb <sub>f</sub> )	$f_B$
<b>2.07 (2.77)</b>	750	26.4 (19.5)	135 (121.7)	4	4/1	1793 (403)	4.4
	500	39.6 (29.2)	155 (114.3)	6	6/1	2052 (461.3)	3.3
	298 177	66.4 (49) 112 (82.6)	184 (135.7) 384 (283.2)	10 17	2881/286 559/33	2439 (548.3) 3383 (760.5)	2.4 2.9
	129	153 (112.9)	220 (162.3)	23	2967/128	3220 (723.9)	1.2
	129	154 (113.6)	385 (284)	23	559/24	3762 (845.7)	2.1
	86	229 (168.9)	600 (442.6)	35	4171/120	6879 (1546.5)	2.2
<b>2.03 (2.72)</b>	62	313 (230.9)	1000 (737.6)	48	2697/56	9210 (2070.5)	2.7
	39	495 (365.1)	1600 (1180.2)	76	126697/1664	12763 (2869.2)	2.7
<b>3.20 (4.29)</b>	750	40.7 (30)	135 (99.6)	4	4/1	1793 (403)	2.2
	500	61.1 (45.1)	155 (114.3)	6	6/1	2052 (461.3)	1.7
	500	61.1 (45.1)	271 (199.9)	6	6/1	2394 (538.2)	2.9
	298	103 (76)	184 (135.7)	10	2881/286	2439 (548.3)	1.2
	324 177	94.4 (69.6) 173 (127.6)	314 (231.6) 384 (283.2)	9.3 17	1075/116 559/33	2767 (622) 3383 (760.5)	2.2 1.5
	177	173 (127.6)	575 (424.1)	17	559/33	5414 (1217.1)	2.2
	129	237 (174.8)	385 (284)	23	559/24	3762 (845.7)	1.1
<b>3.14 (4.21)</b>	123	244 (180)	1000 (737.6)	24	11687/480	7337 (1649.4)	2.7
	93	324 (239)	1000 (737.6)	32	20677/640	8062 (1812.4)	2.0
	62	483 (356.3)	1000 (737.6)	48	2697/56	9210 (2070.5)	1.4
	63	479 (353.3)	1600 (1180.2)	48	39711/832	10923 (2455.6)	2.2
	46	648 (478)	1000 (737.6)	65	12586/195	10154 (2282.7)	1.0
	46	651 (480.2)	2574 (1898.6)	65	33201/512	16635 (3739.7)	2.6
<b>3.19 (4.28)</b>	86	354 (261.1)	600 (442.6)	35	4171/120	6879 (1546.5)	1.1
<b>3.66 (4.91)</b>	750	46.6 (34.4)	356 (262.6)	4	4/1	3346 (752.2)	5.1
	500	69.8 (51.5)	407 (300.2)	6	6/1	3830 (861)	3.9
	297	118 (87)	484 (357)	10	1333/132	4556 (1024.2)	2.7
	177	197 (145.3)	575 (424.1)	17	559/33	5414 (1217.1)	1.9
	129	271 (199.9)	600 (442.6)	23	559/24	6020 (1353.3)	1.5
<b>3.60 (4.83)</b>	123	279 (205.8)	1000 (737.6)	24	11687/480	7337 (1649.4)	2.4
	93	371 (273.6)	1000 (737.6)	32	20677/640	8062 (1812.4)	1.8
	87	397 (292.8)	1600 (1180.2)	35	35441/1024	9813 (2206)	2.7
	60	572 (421.9)	2600 (1917.8)	50	166005/3328	15242 (3426.5)	3.0
	46	744 (548.8)	2600 (1917.8)	65	33201/512	16635 (3739.7)	2.3



# Servo Motors for SIMOVERT MASTERDRIVES

## Synchronous Servo Motors

### 1FK7 Geared Servo Motors Bevel Geared Motors

	Gear Size	Motor Type	SH	Bevel Geared Motors			Order codes			Approx. Total Weight kg (lb)
				Order No.	Gearbox Type	Type of Construction	Mounting Position Type			
	K202	80		1FK7080 – 5AF71 – 1 ■ ■ 5 – Z	B21	G ■ ■	H ■ ■		28 (61.7)	
	K202	80		1FK7080 – 5AF71 – 1 ■ ■ 5 – Z	B22	G ■ ■	H ■ ■		28 (61.7)	
	K202	80		1FK7080 – 5AF71 – 1 ■ ■ 5 – Z	B23	G ■ ■	H ■ ■		28 (61.7)	
	K302	80		1FK7080 – 5AF71 – 1 ■ ■ 5 – Z	B34	G ■ ■	H ■ ■		33 (72.8)	
	K202	80		1FK7080 – 5AF71 – 1 ■ ■ 5 – Z	B25	G ■ ■	H ■ ■		28 (61.7)	
	K302	80		1FK7080 – 5AF71 – 1 ■ ■ 5 – Z	B35	G ■ ■	H ■ ■		33 (72.8)	
	K402	80		1FK7080 – 5AF71 – 1 ■ ■ 5 – Z	B46	G ■ ■	H ■ ■		46.5 (102.5)	
	K513	80		1FK7080 – 5AF71 – 1 ■ ■ 5 – Z	B57	G ■ ■	H ■ ■		52.3 (115.3)	
	K613	80		1FK7080 – 5AF71 – 1 ■ ■ 5 – Z	B68	G ■ ■	H ■ ■		73.8 (162.7)	
	K202	80		1FK7083 – 5AF71 – 1 ■ ■ 5 – Z	B21	G ■ ■	H ■ ■		33.2 (73.2)	
	K202	80		1FK7083 – 5AF71 – 1 ■ ■ 5 – Z	B22	G ■ ■	H ■ ■		33.2 (73.2)	
	K302	80		1FK7083 – 5AF71 – 1 ■ ■ 5 – Z	B32	G ■ ■	H ■ ■		38.2 (84.2)	
	K202	80		1FK7083 – 5AF71 – 1 ■ ■ 5 – Z	B23	G ■ ■	H ■ ■		33.2 (73.2)	
	K302	80		1FK7083 – 5AF71 – 1 ■ ■ 5 – Z	B33	G ■ ■	H ■ ■		38.2 (84.2)	
	K302	80		1FK7083 – 5AF71 – 1 ■ ■ 5 – Z	B34	G ■ ■	H ■ ■		38.2 (84.2)	
	K402	80		1FK7083 – 5AF71 – 1 ■ ■ 5 – Z	B44	G ■ ■	H ■ ■		51.7 (114)	
	K302	80		1FK7083 – 5AF71 – 1 ■ ■ 5 – Z	B35	G ■ ■	H ■ ■		38.2 (84.2)	
	K513	80		1FK7083 – 5AF71 – 1 ■ ■ 5 – Z	B55	G ■ ■	H ■ ■		57.5 (126.8)	
	K513	80		1FK7083 – 5AF71 – 1 ■ ■ 5 – Z	B56	G ■ ■	H ■ ■		57.5 (126.8)	
	K513	80		1FK7083 – 5AF71 – 1 ■ ■ 5 – Z	B57	G ■ ■	H ■ ■		57.5 (126.8)	
	K613	80		1FK7083 – 5AF71 – 1 ■ ■ 5 – Z	B67	G ■ ■	H ■ ■		79 (174.2)	
	K513	80		1FK7083 – 5AF71 – 1 ■ ■ 5 – Z	B58	G ■ ■	H ■ ■		57.5 (126.8)	
	K713	80		1FK7083 – 5AF71 – 1 ■ ■ 5 – Z	B78	G ■ ■	H ■ ■		107.3 (236.6)	
	K402	80		1FK7083 – 5AF71 – 1 ■ ■ 5 – Z	B46	G ■ ■	H ■ ■		51.7 (114)	
	K402	100		1FK7100 – 5AF71 – 1 ■ ■ 5 – Z	B41	G ■ ■	H ■ ■		53.9 (118.4)	
	K402	100		1FK7100 – 5AF71 – 1 ■ ■ 5 – Z	B42	G ■ ■	H ■ ■		53.9 (118.4)	
	K402	100		1FK7100 – 5AF71 – 1 ■ ■ 5 – Z	B43	G ■ ■	H ■ ■		53.9 (118.4)	
	K402	100		1FK7100 – 5AF71 – 1 ■ ■ 5 – Z	B44	G ■ ■	H ■ ■		53.9 (118.4)	
	K402	100		1FK7100 – 5AF71 – 1 ■ ■ 5 – Z	B45	G ■ ■	H ■ ■		53.9 (118.4)	
	K513	100		1FK7100 – 5AF71 – 1 ■ ■ 5 – Z	B55	G ■ ■	H ■ ■		59.7 (131.6)	
	K513	100		1FK7100 – 5AF71 – 1 ■ ■ 5 – Z	B56	G ■ ■	H ■ ■		59.7 (131.6)	
	K613	100		1FK7100 – 5AF71 – 1 ■ ■ 5 – Z	B66	G ■ ■	H ■ ■		81.2 (179)	
	K713	100		1FK7100 – 5AF71 – 1 ■ ■ 5 – Z	B77	G ■ ■	H ■ ■		109.5 (241.4)	
	K713	100		1FK7100 – 5AF71 – 1 ■ ■ 5 – Z	B78	G ■ ■	H ■ ■		109.5 (241.4)	
• Encoder system in motor:	Incremental encoder sin/cos 1 V <sub>pp</sub> Absolute encoder EnDat 2,048 pulses/revolution (shaft height 48 and higher) Simple absolute encoder EnDat 32 pulses/revolution (shaft height 48 and higher) Resolver, multipole (pole number = pole number for motor) Resolver, 2-pole			A E G S T						
• Holding brake:	Motor <b>without</b> holding brake Motor <b>with</b> holding brake			U V						

For order codes for type of construction, design, and mounting position, see page 4/32



# Servo Motors for SIMOVERT MASTERDRIVES

## Synchronous Servo Motors

### 1FK7 Geared Servo Motors Bevel Geared Motors

#### Selection and Ordering Data

Output (S3 60%) $P_2$ kW (HP)	Output Speed $n_2$ rpm	Rated Output Torque $M_2$ Nm (lb <sub>f</sub> -ft)	Max. Permiss. Acceleration Torque $M_{2max}$ Nm (lb <sub>f</sub> -ft)	Nominal Ratio $i_{nom}$	Exact Ratio $i_{exact}$	Cantilever Force Gear Shaft End $F_{rperm}$ N (lb <sub>f</sub> )	Overload Factor $f_B$
<b>4.72 (6.33)</b>	750	60.1 (44.3)	356 (262.6)	4	4/1	3346 (752)	3.4
	500	90.2 (66.5)	407 (300.2)	6	6/1	3830 (861)	2.6
<b>4.66 (6.25)</b>	297	152 (112.1)	484 (357)	10	1333/132	4556 (1024)	1.8
	177	255 (188.1)	575 (424.1)	17	559/33	5414 (1217)	1.3
	186	238 (175.5)	1000 (737.6)	16	26071/1620	6391 (1436)	2.4
<b>4.64 (6.22)</b>	123	361 (266.3)	1000 (737.6)	24	11687/480	7337 (1649)	1.6
	125	356 (262.6)	1584 (1168.4)	24	24583/1024	8687 (1953)	2.6
	87	513 (378.4)	1600 (1180.2)	35	35441/1024	9813 (2206)	1.8
<b>4.63 (6.21)</b>	85	525 (387.2)	2600 (1917.8)	35	567/16	13600 (3057)	2.8
	60	739 (545.1)	2600 (1917.8)	50	166005/3328	15242 (3427)	2.0
<b>4.67 (6.26)</b>	46	961 (708.8)	2600 (1917.8)	65	33201/512	16635 (3740)	1.6
<b>4.67 (6.26)</b>	46	969 (714.7)	4650 (3429.8)	65	188387/2880	21991 (4944)	2.8
<b>5.17 (6.93)</b>	625	79 (58.3)	356 (262.6)	4	4/1	3346 (752)	2.5
<b>5.20 (6.97)</b>	417	119 (87.8)	407 (300.2)	6	6/1	3830 (861)	1.9
<b>5.19 (6.96)</b>	248	200 (147.5)	484 (357)	10	1333/132	4556 (1024)	1.4
<b>5.13 (6.88)</b>	246	199 (146.8)	900 (663.8)	10	203/20	5481 (1232)	2.6
	155	315 (232.3)	1000 (737.6)	16	26071/1620	6391 (1436)	1.8
	158	310 (228.7)	1380 (1017.8)	16	54839/3456	7567 (1701)	2.5
	103	477 (351.8)	1000 (737.6)	24	11687/480	7337 (1649)	1.2
<b>5.16 (6.92)</b>	104	470 (346.7)	1584 (1168.4)	24	24583/1024	8687 (1953)	1.9
	72	678 (500.1)	1600 (1180.2)	35	35441/1024	9813 (2206)	1.3
<b>5.12 (6.86)</b>	71	694 (511.9)	2600 (1917.8)	35	567/16	13600 (3057)	2.1
<b>5.12 (6.86)</b>	50	978 (721.4)	2600 (1917.8)	50	166005/3328	15242 (3427)	1.5
<b>5.13 (6.88)</b>	51	960 (708.1)	4650 (3429.8)	49	5487/112	19971 (4490)	2.8
<b>5.19 (6.96)</b>	39	1271 (937.5)	2600 (1917.8)	65	33201/512	16635 (3740)	1.2
<b>5.09 (6.82)</b>	38	1280 (944.1)	4650 (3429.8)	65	188387/2880	21991 (4944)	2.1
<b>7.93 (10.63)</b>	750	101 (74.5)	356 (262.6)	4	4/1	3346 (752)	1.9
	500	151 (111.4)	407 (300.2)	6	6/1	3830 (861)	1.5
<b>7.81 (10.47)</b>	296	252 (185.9)	900 (663.8)	10	203/20	5481 (1232)	1.9
<b>7.93 (10.60)</b>	297	255 (188.1)	484 (357)	10	1333/132	4556 (1024)	1.0
<b>7.80 (10.46)</b>	189	394 (290.6)	1380 (1017.8)	16	54839/3456	7567 (1701)	1.9
	186	400 (295)	1000 (737.6)	16	26071/1620	6391 (1436)	1.4
	125	597 (440.3)	1584 (1168.4)	24	24583/1024	8687 (1953)	1.4
<b>7.84 (10.51)</b>	119	626 (461.7)	2600 (1917.8)	25	64449/2560	12135 (2732)	2.3
	85	881 (649.8)	2600 (1917.8)	35	567/16	3276 (736)	1.6
<b>7.80 (10.46)</b>	83	898 (662.4)	4255 (3138.5)	36	2891/80	18045 (4057)	2.6
	61	1218 (898.4)	4650 (3429.8)	49	5487/112	19971 (4490)	2.1
	60	1240 (914.6)	2600 (1917.8)	50	166005/3328	15242 (3427)	1.1
<b>7.84 (10.51)</b>	42	1782 (1314.4)	4326 (3190.9)	72	10325/144	22675 (5098)	1.3

# Servo Motors for SIMOVERT MASTERDRIVES

## Synchronous Servo Motors

### 1FK7 Geared Servo Motors Bevel Geared Motors

	Gear Size	Motor Type	Bevel Geared Motors				Approx. Total Weight kg (lb)
			Order No.	Order codes	Gearbox Type	Type of Construction	
		SH					
	K402	100	1FK7101 – 5AF71 – 1 ■ ■ 5 – Z	B41	G ■ ■	H ■ ■	59.5 (131.2)
	K402	100	1FK7101 – 5AF71 – 1 ■ ■ 5 – Z	B42	G ■ ■	H ■ ■	59.5 (131.2)
	K402	100	1FK7101 – 5AF71 – 1 ■ ■ 5 – Z	B43	G ■ ■	H ■ ■	59.5 (131.2)
	K402	100	1FK7101 – 5AF71 – 1 ■ ■ 5 – Z	B44	G ■ ■	H ■ ■	59.5 (131.2)
	K513	100	1FK7101 – 5AF71 – 1 ■ ■ 5 – Z	B54	G ■ ■	H ■ ■	65.3 (145)
	K513	100	1FK7101 – 5AF71 – 1 ■ ■ 5 – Z	B55	G ■ ■	H ■ ■	65.3 (145)
	K613	100	1FK7101 – 5AF71 – 1 ■ ■ 5 – Z	B65	G ■ ■	H ■ ■	86.8 (191.4)
	K613	100	1FK7101 – 5AF71 – 1 ■ ■ 5 – Z	B66	G ■ ■	H ■ ■	86.8 (191.4)
	K713	100	1FK7101 – 5AF71 – 1 ■ ■ 5 – Z	B76	G ■ ■	H ■ ■	115.1 (253.8)
	K713	100	1FK7101 – 5AF71 – 1 ■ ■ 5 – Z	B77	G ■ ■	H ■ ■	115.1 (253.8)
	K713	100	1FK7101 – 5AF71 – 1 ■ ■ 5 – Z	B77	G ■ ■	H ■ ■	115.1 (253.8)
	K813	100	1FK7101 – 5AF71 – 1 ■ ■ 5 – Z	B88	G ■ ■	H ■ ■	168.5 (371.5)
	K402	100	1FK7103 – 5AF71 – 1 ■ ■ 5 – Z	B41	G ■ ■	H ■ ■	66.1 (145.8)
	K402	100	1FK7103 – 5AF71 – 1 ■ ■ 5 – Z	B42	G ■ ■	H ■ ■	66.1 (145.8)
	K402	100	1FK7103 – 5AF71 – 1 ■ ■ 5 – Z	B43	G ■ ■	H ■ ■	66.1 (145.8)
	K513	100	1FK7103 – 5AF71 – 1 ■ ■ 5 – Z	B53	G ■ ■	H ■ ■	71.9 (158.5)
	K513	100	1FK7103 – 5AF71 – 1 ■ ■ 5 – Z	B54	G ■ ■	H ■ ■	71.9 (158.5)
	K613	100	1FK7103 – 5AF71 – 1 ■ ■ 5 – Z	B64	G ■ ■	H ■ ■	93.4 (205.9)
	K513	100	1FK7103 – 5AF71 – 1 ■ ■ 5 – Z	B55	G ■ ■	H ■ ■	71.9 (158.5)
	K613	100	1FK7103 – 5AF71 – 1 ■ ■ 5 – Z	B65	G ■ ■	H ■ ■	93.4 (205.9)
	K613	100	1FK7103 – 5AF71 – 1 ■ ■ 5 – Z	B66	G ■ ■	H ■ ■	93.4 (205.9)
	K713	100	1FK7103 – 5AF71 – 1 ■ ■ 5 – Z	B76	G ■ ■	H ■ ■	121.7 (268.3)
	K713	100	1FK7103 – 5AF71 – 1 ■ ■ 5 – Z	B77	G ■ ■	H ■ ■	121.7 (268.3)
	K813	100	1FK7103 – 5AF71 – 1 ■ ■ 5 – Z	B87	G ■ ■	H ■ ■	175.1 (386.1)
	K713	100	1FK7103 – 5AF71 – 1 ■ ■ 5 – Z	B78	G ■ ■	H ■ ■	121.7 (268.3)
	K813	100	1FK7103 – 5AF71 – 1 ■ ■ 5 – Z	B88	G ■ ■	H ■ ■	175.1 (386.1)
	K402	100	1FK7105 – 5AF71 – 1 ■ ■ 5 – Z	B41	G ■ ■	H ■ ■	76.1 (167.8)
	K402	100	1FK7105 – 5AF71 – 1 ■ ■ 5 – Z	B42	G ■ ■	H ■ ■	76.1 (167.8)
	K513	100	1FK7105 – 5AF71 – 1 ■ ■ 5 – Z	B53	G ■ ■	H ■ ■	82 (180.8)
	K402	100	1FK7105 – 5AF71 – 1 ■ ■ 5 – Z	B43	G ■ ■	H ■ ■	76.1 (167.8)
	K613	100	1FK7105 – 5AF71 – 1 ■ ■ 5 – Z	B64	G ■ ■	H ■ ■	103 (227.1)
	K513	100	1FK7105 – 5AF71 – 1 ■ ■ 5 – Z	B54	G ■ ■	H ■ ■	82 (180.8)
	K613	100	1FK7105 – 5AF71 – 1 ■ ■ 5 – Z	B65	G ■ ■	H ■ ■	103 (227.1)
	K713	100	1FK7105 – 5AF71 – 1 ■ ■ 5 – Z	B75	G ■ ■	H ■ ■	132 (291.1)
	K713	100	1FK7105 – 5AF71 – 1 ■ ■ 5 – Z	B76	G ■ ■	H ■ ■	132 (291.1)
	K813	100	1FK7105 – 5AF71 – 1 ■ ■ 5 – Z	B86	G ■ ■	H ■ ■	185 (407.9)
	K813	100	1FK7105 – 5AF71 – 1 ■ ■ 5 – Z	B87	G ■ ■	H ■ ■	185 (407.9)
	K713	100	1FK7105 – 5AF71 – 1 ■ ■ 5 – Z	B77	G ■ ■	H ■ ■	132 (291.1)
	K813	100	1FK7105 – 5AF71 – 1 ■ ■ 5 – Z	B88	G ■ ■	H ■ ■	185 (407.9)
• Encoder system in motor:	Incremental encoder sin/cos 1 V <sub>pp</sub> Absolute encoder EnDat 2,048 pulses/revolution (shaft height 48 and higher) Simple absolute encoder EnDat 32 pulses/revolution (shaft height 48 and higher) Resolver, multipole (pole number = pole number for motor) Resolver, 2-pole		A E G S T				
• Holding brake:	Motor <b>without</b> holding brake Motor <b>with</b> holding brake		U V				

For order codes for type of construction, design, and mounting position, see page 4/32

# Servo Motors for SIMOVERT MASTERDRIVES

## Synchronous Servo Motors

### 1FK7 Geared Servo Motors Worm Geared Motors

#### Selection and Ordering Data

Output (S3 60%) $P_2$ kW (HP)	Output Speed $n_2$ rpm	Rated Output Torque $M_2$ Nm (lb <sub>f</sub> -ft)	Max. Permiss. Acceleration Torque $M_{2max}$ Nm (lb <sub>f</sub> -ft)	Nominal Ratio $i_{nom}$	Exact Ratio $i_{exact}$	Cantilever Force Gear Shaft End $F_{rperm}$ N (lb <sub>f</sub> )	Overload Factor $f_B$
<b>0.28 (0.38)</b>	312	8.5 (6.3)	43 (31.7)	9.6	1107/115	1689 (379.7)	4.1
	172	15.3 (11.3)	73 (53.8)	17.5	297/17	1938 (445.8)	3.9
<b>0.27 (0.36)</b>	128	20.2 (14.9)	82 (60.5)	23	117/5	2271 (510.5)	3.3
	86	30 (22.1)	125 (92.2)	35	873/25	2441 (548.8)	3.4
<b>0.24 (0.32)</b>	51	45.6 (33.6)	88 (64.9)	59	117/2	3082 (692.9)	1.6
	52	45.8 (33.8)	172 (126.9)	58	405/7	2889 (649.5)	3.1
	40	57.7 (42.6)	96 (70.8)	75	747/10	3343 (751.5)	1.4
	43	54.8 (40.4)	184 (135.7)	70	279/4	3075 (691.3)	2.7
<b>0.38 (0.51)</b>	172	21.2 (15.6)	110 (81.1)	17.5	297/17	1938 (445.8)	4.4
	86	41.6 (30.7)	150 (110.6)	35	873/25	2441 (548.8)	3.0
<b>0.35 (0.47)</b>	52	63.4 (46.8)	172 (126.9)	58	405/7	2889 (649.5)	2.3
	43	75.9 (56)	184 (135.7)	70	279/4	3075 (691.3)	2.0
<b>0.73 (0.98)</b>	172	40.8 (30.1)	110 (81.1)	17.5	297/17	1938 (445.8)	2.3
	130	53.6 (39.5)	132 (97.4)	23	162/7	2128 (478.4)	2.1
<b>0.72 (0.97)</b>	86	80.1 (59.1)	150 (110.6)	35	873/25	2441 (548.8)	1.6
	86	79.9 (58.9)	252 (185.9)	35	243/7	3411 (766.8)	2.7
<b>0.66 (0.88)</b>	52	122 (90)	172 (126.9)	58	405/7	2889 (649.5)	1.2
<b>0.69 (0.92)</b>	52	126 (92.9)	302 (222.8)	58	1863/32	4053 (911.2)	2.1
<b>0.66 (0.88)</b>	43	146 (107.7)	184 (135.7)	70	279/4	3075 (691.3)	1.1
<b>0.68 (0.91)</b>	43	151 (111.4)	324 (239)	70	351/5	4314 (969.8)	1.9
<b>1.35 (1.81)</b>	326	39.5 (29.1)	74 (54.6)	9.2	46/5	1565 (351.8)	1.5
<b>1.33 (1.78)</b>	172	73.7 (54.4)	110 (81.1)	17.5	297/17	1938 (445.8)	1.2
	171	74.4 (54.9)	217 (160.1)	17.5	351/20	2717 (610.8)	2.3
<b>1.31 (1.76)</b>	129	97.9 (72.2)	259 (191)	23	1863/80	2986 (671.8)	2.1
	86	144 (106.2)	310 (228.7)	35	243/7	3411 (766.8)	1.7
	86	146 (107.7)	498 (367.3)	35	2268/65	4881 (1097.3)	2.7
<b>1.24 (1.66)</b>	52	227 (167.4)	302 (222.8)	58	1863/32	4053 (911.2)	1.0
	51	232 (171.1)	561 (413.8)	59	117/2	5799 (1303.7)	1.9
	43	275 (202.8)	609 (449.2)	70	2241/32	6157 (1384.1)	1.7
	43	277 (204.3)	791 (583.4)	70	279/4	7994 (1797.1)	2.2

# Servo Motors for SIMOVERT MASTERDRIVES

## Synchronous Servo Motors

### 1FK7 Geared Servo Motors Worm Geared Motors

Gear Size	Motor Type	SH	Worm Geared Motors Order No.	Order codes			Approx. Total Weight kg (lb)
				Gearbox Type	Type of Construction	Mounting Position Type	
S002 S102	36 36	36 36	1FK7032 – 5AK71 – 1 ■ ■ 5 – Z	E03	G ■ ■	H ■ ■	6.6 (14.6)
			1FK7032 – 5AK71 – 1 ■ ■ 5 – Z	E14	G ■ ■	H ■ ■	12.9 (28.4)
S002 S102	36 36	36 36	1FK7032 – 5AK71 – 1 ■ ■ 5 – Z	E05	G ■ ■	H ■ ■	6.6 (14.6)
			1FK7032 – 5AK71 – 1 ■ ■ 5 – Z	E16	G ■ ■	H ■ ■	12.9 (28.4)
S002 S102	36 36	36 36	1FK7032 – 5AK71 – 1 ■ ■ 5 – Z	E07	G ■ ■	H ■ ■	6.6 (14.6)
			1FK7032 – 5AK71 – 1 ■ ■ 5 – Z	E17	G ■ ■	H ■ ■	12.9 (28.4)
S002 S102	36 36	36 36	1FK7032 – 5AK71 – 1 ■ ■ 5 – Z	E08	G ■ ■	H ■ ■	6.6 (14.6)
			1FK7032 – 5AK71 – 1 ■ ■ 5 – Z	E18	G ■ ■	H ■ ■	12.9 (28.4)
S102 S102	48 48	48 48	1FK7040 – 5AK71 – 1 ■ ■ 5 – Z	E14	G ■ ■	H ■ ■	13.7 (30.2)
			1FK7040 – 5AK71 – 1 ■ ■ 5 – Z	E16	G ■ ■	H ■ ■	13.7 (30.2)
S102 S102	48 48	48 48	1FK7040 – 5AK71 – 1 ■ ■ 5 – Z	E17	G ■ ■	H ■ ■	13.7 (30.2)
			1FK7040 – 5AK71 – 1 ■ ■ 5 – Z	E18	G ■ ■	H ■ ■	13.7 (30.2)
S102 S102	48 48	48 48	1FK7042 – 5AF71 – 1 ■ ■ 5 – Z	E14	G ■ ■	H ■ ■	15 (33.1)
			1FK7042 – 5AF71 – 1 ■ ■ 5 – Z	E15	G ■ ■	H ■ ■	15 (33.1)
S102 S202	48 48	48 48	1FK7042 – 5AF71 – 1 ■ ■ 5 – Z	E16	G ■ ■	H ■ ■	15 (33.1)
			1FK7042 – 5AF71 – 1 ■ ■ 5 – Z	E26	G ■ ■	H ■ ■	22.5 (49.6)
S102	48	48	1FK7042 – 5AF71 – 1 ■ ■ 5 – Z	E17	G ■ ■	H ■ ■	15 (33.1)
S202	48	48	1FK7042 – 5AF71 – 1 ■ ■ 5 – Z	E27	G ■ ■	H ■ ■	22.5 (49.6)
S102	48	48	1FK7042 – 5AF71 – 1 ■ ■ 5 – Z	E18	G ■ ■	H ■ ■	15 (33.1)
S202	48	48	1FK7042 – 5AF71 – 1 ■ ■ 5 – Z	E28	G ■ ■	H ■ ■	22.5 (49.6)
S102	63	63	1FK7060 – 5AF71 – 1 ■ ■ 5 – Z	E13	G ■ ■	H ■ ■	17.7 (39)
S102 S202	63 63	63 63	1FK7060 – 5AF71 – 1 ■ ■ 5 – Z	E14	G ■ ■	H ■ ■	17.7 (39)
			1FK7060 – 5AF71 – 1 ■ ■ 5 – Z	E24	G ■ ■	H ■ ■	25.2 (55.6)
S202 S202 S302	63 63 63	63 63 63	1FK7060 – 5AF71 – 1 ■ ■ 5 – Z	E25	G ■ ■	H ■ ■	25.2 (55.6)
			1FK7060 – 5AF71 – 1 ■ ■ 5 – Z	E26	G ■ ■	H ■ ■	25.2 (55.6)
			1FK7060 – 5AF71 – 1 ■ ■ 5 – Z	E36	G ■ ■	H ■ ■	34.4 (75.6)
S202 S302	63 63	63 63	1FK7060 – 5AF71 – 1 ■ ■ 5 – Z	E27	G ■ ■	H ■ ■	25.2 (55.6)
			1FK7060 – 5AF71 – 1 ■ ■ 5 – Z	E37	G ■ ■	H ■ ■	34.4 (75.6)
S302 S402	63 63	63 63	1FK7060 – 5AF71 – 1 ■ ■ 5 – Z	E38	G ■ ■	H ■ ■	34.4 (75.6)
			1FK7060 – 5AF71 – 1 ■ ■ 5 – Z	E48	G ■ ■	H ■ ■	43.6 (96.1)
<ul style="list-style-type: none"> <li>Encoder system in motor:           <ul style="list-style-type: none"> <li>Incremental encoder sin/cos 1 V<sub>pp</sub></li> <li>Absolute encoder EnDat 2,048 pulses/revolution (shaft height 48 and higher)</li> <li>Absolute encoder EnDat 512 pulses/revolution (shaft height 36 only)</li> <li>Simple absolute encoder EnDat 32 pulses/revolution (shaft height 48 and higher)</li> <li>Resolver, multipole (pole number = pole number for motor)</li> <li>Resolver, 2-pole</li> </ul> </li> <li>Holding brake:           <ul style="list-style-type: none"> <li>Motor <b>without</b> holding brake</li> <li>Motor <b>with</b> holding brake</li> </ul> </li> </ul>		A E H G S T U V					

For order codes for type of construction, design, and mounting position, see page 4/32

# Servo Motors for SIMOVERT MASTERDRIVES

## Synchronous Servo Motors

### 1FK7 Geared Servo Motors Worm Geared Motors

#### Selection and Ordering Data

Output (S3 60%)	Output Speed	Rated Output Torque	Max. Permiss. Acceleration Torque	Nominal Ratio	Exact Ratio	Cantilever Force Gear Shaft End	Overload Factor
$P_2$ kW (HP)	$n_2$ rpm	$M_2$ Nm (lb <sub>f</sub> -ft)	$M_{2max}$ Nm (lb <sub>f</sub> -ft)	$i_{nom}$	$i_{exact}$	$F_{rperm}$ N (lb <sub>f</sub> )	$f_B$
<b>2.11 (2.89)</b>	325	61.9 (45.7)	126 (92.2)	9.2	1431/155	2194 (493.2)	1.4
<b>2.08 (2.79)</b>	171	116 (85.6)	217 (160.1)	17.5	351/20	2717 (610.8)	1.2
<b>2.05 (2.75)</b>	129 86	152 (112.1) 227 (167.4)	259 (191) 498 (367.3)	23 35	1863/80 2268/65	2986 (671.8) 4881 (1097.3)	1.1 1.5
<b>1.92 (2.57)</b>	51	360 (265.5)	561 (413.8)	59	117/2	5799 (1303.7)	1.0
<b>1.94 (2.6)</b>	43	430 (317.2)	791 (583.4)	70	279/4	7994 (1797.1)	1.2
<b>1.93 (2.59)</b>	171	108 (79.7)	217 (160.1)	17.5	351/20	2717 (610.8)	1.7
	173 129	107 (78.9) 142 (104.7)	373 (275.1) 259 (191)	17.5 23	1998/115 1863/80	3869 (869.8) 2986 (671.3)	3.0 1.6
	128 86	144 (106.2) 213 (157.1)	458 (337.8) 720 (531.1)	23 35	117/5 873/25	4273 (960.6) 6347 (1426.9)	2.7 2.9
<b>1.79 (2.4)</b>	51 43	335 (247.1) 399 (294.3)	561 (413.8) 609 (449.2)	59 70	117/2 2241/32	5799 (1303.7) 6157 (1384.2)	1.4 1.3
<b>3.05 (4.09)</b>	322	90.5 (66.8)	216 (159.3)	9.3	270/29	3143 (706.6)	1.6
<b>3.01 (4.03)</b>	173	166 (122.4)	373 (275.1)	17.5	1998/115	3869 (869.8)	1.5
<b>3.03 (4.06)</b>	172	168 (123.9)	557 (410.8)	17.5	612/35	5040 (1133)	2.2
<b>2.98 (3.99)</b>	128 128	222 (163.7) 222 (163.7)	458 (337.8) 685 (505.3)	23 23	117/5 117/5	4273 (960.6) 5554 (1248.6)	1.4 2.0
<b>2.95 (3.95)</b>	86	328 (241.9)	720 (531.1)	35	873/25	6347 (1426.9)	1.4
<b>3.47 (4.65)</b>	259	128 (94.4)	371 (273.6)	11.5	81/7	4392 (987.4)	1.9
<b>3.44 (4.61)</b>	172	191 (140.9)	557 (410.8)	17.5	612/35	5040 (1133)	1.9
<b>4.50 (6.03)</b>	259	166 (122.4)	371 (273.6)	11.5	81/7	4392 (987.4)	1.3
<b>4.45 (5.97)</b>	172	247 (182.2)	557 (410.8)	17.5	612/35	5040 (1133)	1.3

# Servo Motors for SIMOVERT MASTERDRIVES

## Synchronous Servo Motors

1FK7 Geared Servo Motors  
Worm Geared Motors

Gear Size	Motor Type	SH	Worm Geared Motors	Order codes			Approx. Total Weight kg (lb)
			Order No.	Gearbox Type	Type of Construction	Mounting Position Type	
S202	63		1FK7063 – 5AF71 – 1 ■ ■ 5 – Z	E23	G ■ ■	H ■ ■	28.9 (63.7)
S202	63		1FK7063 – 5AF71 – 1 ■ ■ 5 – Z	E24	G ■ ■	H ■ ■	28.9 (63.7)
S202	63		1FK7063 – 5AF71 – 1 ■ ■ 5 – Z	E25	G ■ ■	H ■ ■	28.9 (63.7)
S302	63		1FK7063 – 5AF71 – 1 ■ ■ 5 – Z	E36	G ■ ■	H ■ ■	38.1 (84)
S302	63		1FK7063 – 5AF71 – 1 ■ ■ 5 – Z	E37	G ■ ■	H ■ ■	38.1 (84)
S402	63		1FK7063 – 5AF71 – 1 ■ ■ 5 – Z	E48	G ■ ■	H ■ ■	47.3 (104.3)
S202	80		1FK7080 – 5AF71 – 1 ■ ■ 5 – Z	E24	G ■ ■	H ■ ■	28.6 (63.7)
S302	80		1FK7080 – 5AF71 – 1 ■ ■ 5 – Z	E34	G ■ ■	H ■ ■	37.8 (83.3)
S202	80		1FK7080 – 5AF71 – 1 ■ ■ 5 – Z	E25	G ■ ■	H ■ ■	28.6 (63.7)
S302	80		1FK7080 – 5AF71 – 1 ■ ■ 5 – Z	E35	G ■ ■	H ■ ■	37.8 (83.3)
S402	80		1FK7080 – 5AF71 – 1 ■ ■ 5 – Z	E46	G ■ ■	H ■ ■	47 (103.6)
S302	80		1FK7080 – 5AF71 – 1 ■ ■ 5 – Z	E37	G ■ ■	H ■ ■	37.8 (83.3)
S302	80		1FK7080 – 5AF71 – 1 ■ ■ 5 – Z	E38	G ■ ■	H ■ ■	37.8 (83.3)
S302	80		1FK7083 – 5AF71 – 1 ■ ■ 5 – Z	E33	G ■ ■	H ■ ■	43 (94.8)
S302	80		1FK7083 – 5AF71 – 1 ■ ■ 5 – Z	E34	G ■ ■	H ■ ■	43 (94.8)
S402	80		1FK7083 – 5AF71 – 1 ■ ■ 5 – Z	E44	G ■ ■	H ■ ■	52.2 (115.1)
S302	80		1FK7083 – 5AF71 – 1 ■ ■ 5 – Z	E35	G ■ ■	H ■ ■	43 (94.8)
S402	80		1FK7083 – 5AF71 – 1 ■ ■ 5 – Z	E45	G ■ ■	H ■ ■	52.2 (115.1)
S402	80		1FK7083 – 5AF71 – 1 ■ ■ 5 – Z	E46	G ■ ■	H ■ ■	52.2 (115.1)
S402	100		1FK7100 – 5AF71 – 1 ■ ■ 5 – Z	E43	G ■ ■	H ■ ■	54.4 (120)
S402	100		1FK7100 – 5AF71 – 1 ■ ■ 5 – Z	E44	G ■ ■	H ■ ■	54.4 (120)
S402	100		1FK7101 – 5AF71 – 1 ■ ■ 5 – Z	E43	G ■ ■	H ■ ■	60 (132.3)
S402	100		1FK7101 – 5AF71 – 1 ■ ■ 5 – Z	E44	G ■ ■	H ■ ■	60 (132.3)
• Encoder system in motor:		Incremental encoder sin/cos 1 V <sub>pp</sub> Absolute encoder EnDat 2,048 pulses/revolution (shaft height 48 and higher) Simple absolute encoder EnDat 32 pulses/revolution (shaft height 48 and higher) Resolver, multipole (pole number = pole number for motor) Resolver, 2-pole	A E G S T				
• Holding brake:		Motor <b>without</b> holding brake Motor <b>with</b> holding brake	U V				

For order codes for type of construction, design, and mounting position, see page 4/32

4



# Servo Motors for SIMOVERT MASTERDRIVES

## Synchronous Servo Motors

1FK7 Geared Servo Motors

### Selection and Ordering Data

*Helical Geared Motors*  
*Type of construction*

**IM B 3**

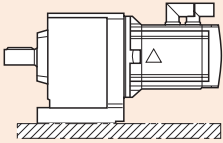

**IM B 5**

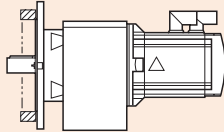

**IM B 14**

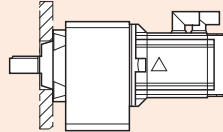

**IM B 34**

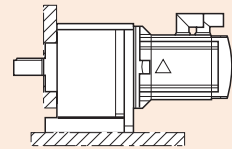

**IM B 35**

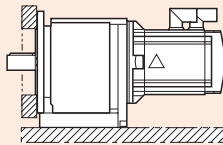

**IM B 6**

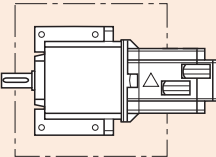

**IM B 7**

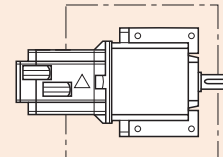

**IM B 8**

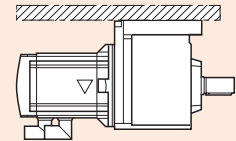

G\_DA65\_XX\_00170

**IM V 1**

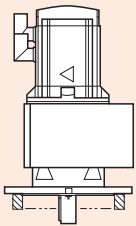

**IM V 18**

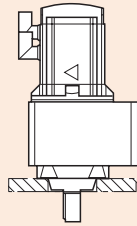

**IM V 19**

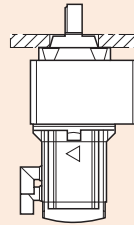

**IM V 3**

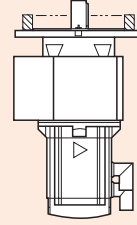

**IM V 5**

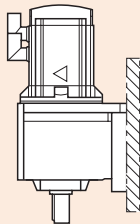

**IM V 6**

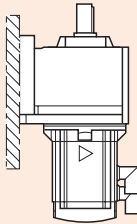



# Servo Motors for SIMOVERT MASTERDRIVES

## Synchronous Servo Motors

### 1FK7 Geared Servo Motors

#### Selection and Ordering Data

##### Offset Shaft Geared Motors Mounting Positions EL 1 to EL 6

For foot-mounted types, the feet are always located on gearbox side 1

##### Bevel Geared Motors Mounting Positions EL 1 to EL 6

4

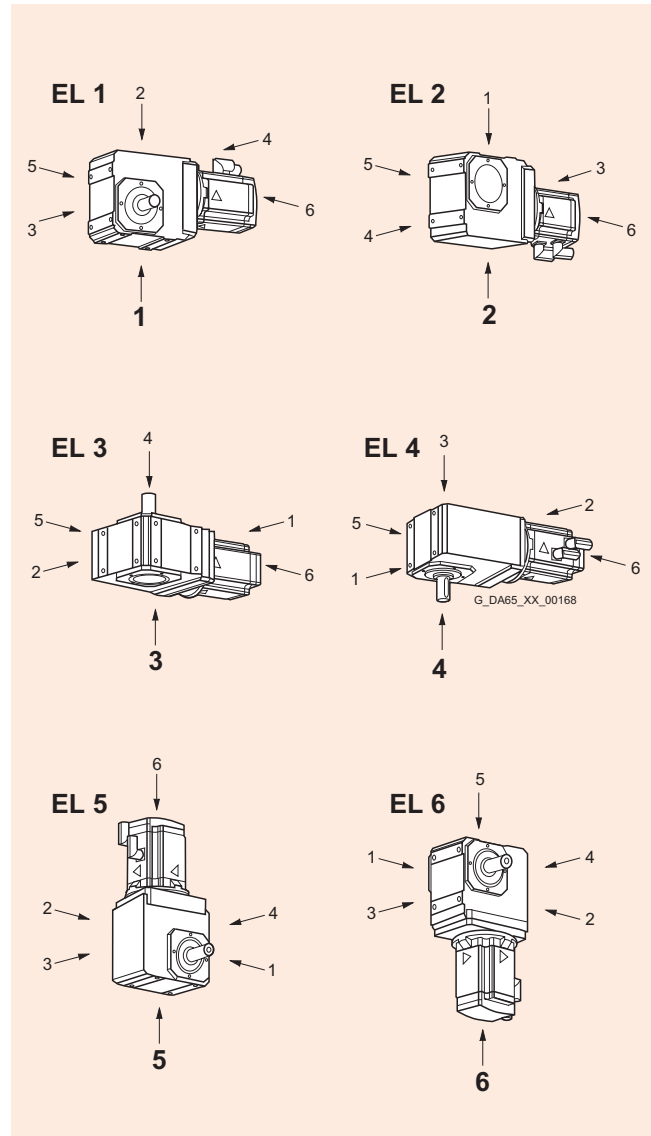
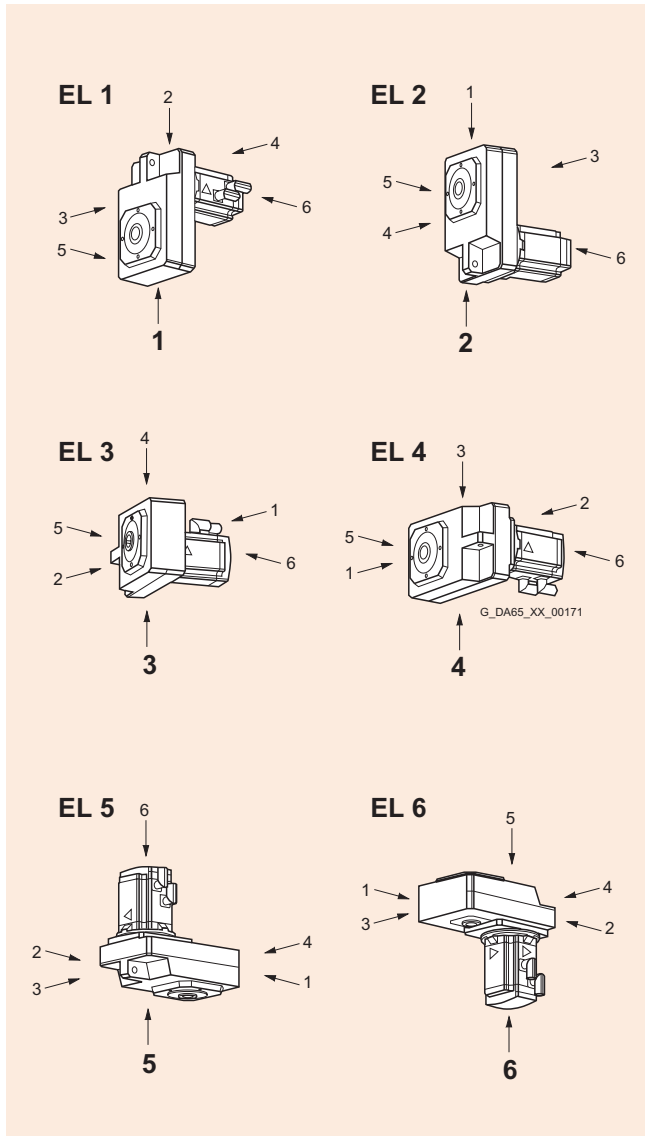

# Servo Motors for SIMOVERT MASTERDRIVES

## Synchronous Servo Motors

1FK7 Geared Servo Motors

### Selection and Ordering Data

#### Worm Geared Motors Mounting Positions EL 1 to EL 6

For foot-mounted types with bases, the feet are always located on gearbox side 1

### Connector Attachment

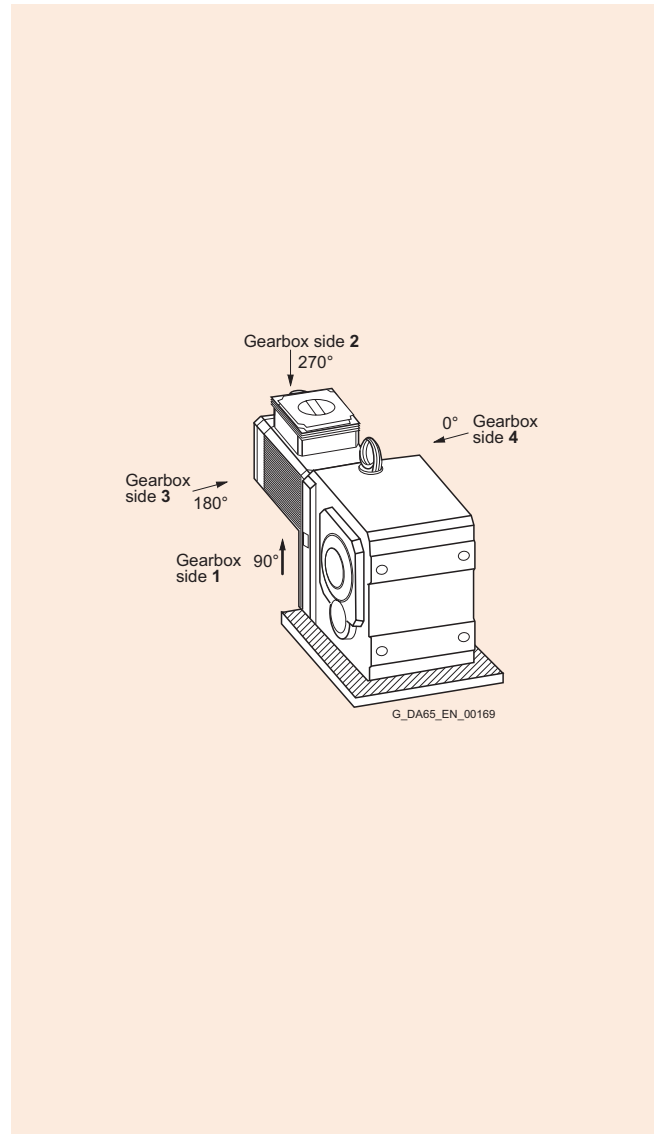
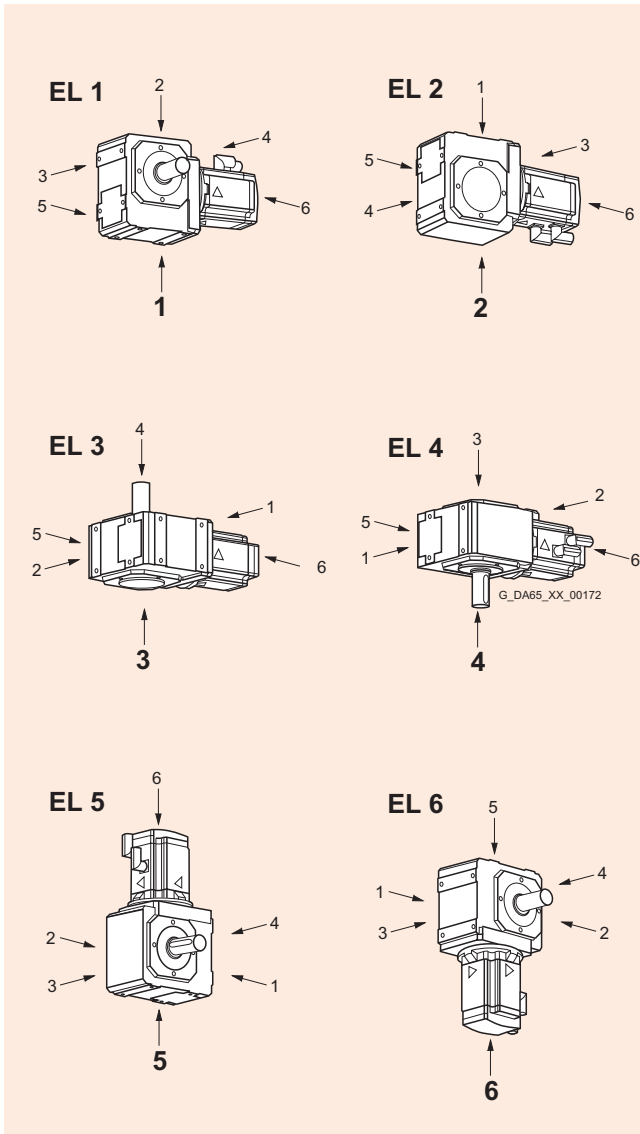

4

# Servo Motors for SIMOVERT MASTERDRIVES

## Gearboxes for 1FK7 Standard Type Motors

### LP Series Planetary Gearbox

#### Overview



LP Series Planetary Gearbox

1FK7 motors can easily be combined with LP series planetary gearboxes to form compact coaxial drive units. The gearboxes are flanged directly to the drive end of the motors.

When selecting the gearboxes, ensure that the permissible speed of the gear unit is not exceeded by the maximum speed of the motor. In the case of high operating frequencies, an allowance must be made for the load factor  $f_2$  (see Planning Guide). The frictional losses of the gearbox must always be taken into account in planning.

The gearboxes are only available in non-balanced design and with fitted key.

#### Uses/Benefits

- High efficiency > 97%
- Torsional backlash: single-stage  $\leq 12$  arcmin
- Power transmission from the central sun gear via planetary gears
- No shaft deflections in the planetary gear set due to the symmetrical force distribution
- The enclosed gear units, filled with grease before leaving the factory, are attached to the shaft by means of an integral clamping hub. This requires a keyless motor shaft end. Radial eccentricity tolerance N in accordance with DIN 42955 is sufficient. The motor flange is adapted via adapter plates.
- Gear oil sealed off from motor in gearbox
- Output shaft of gear unit exactly coaxial with the motor
- The gearboxes can be mounted in any position.
- Gears are filled with grease in the factory. They are lubricated for life and sealed (20,000 h lifespan).
- Degree of protection IP64
- Small dimensions
- Lightweight

#### Integration

The gear units assigned to the individual motors and gear ratios  $i$  available for these motor/gear combinations are listed in the selection table. When making a selection, the maximum permissible input speed of the gearbox must be observed (this is the same as the maximum motor speed).

The motor/gear combinations listed in the selection table are mainly intended for use as positioning drives (S5). At the rated speed and rated torque, continuous duty (S1) is permissible. The gearbox temperature must not exceed +90 °C (+194 °F).

# Servo Motors for SIMOVERT MASTERDRIVES

## Gearboxes for 1FK7 Standard Type Motors

### LP Series Planetary Gearbox

#### Selection and Ordering Data

Ordering data: **1FK7 ...-A.71-1.** **-Z**



**G**  
**H**

Order No. of the motor (standard type) with code “-Z” and code for mounting the planetary gearbox assigned to the motor  
Requirement: Keyless motor shaft

Motor Natural cooling	<b>Planetary Gearbox Single-Stage</b>	<b>Available Gear Ratios <math>i =</math></b>		Max. Permiss. Input Speed <sup>1)</sup>	Max. Permiss. Output Torque <sup>1)</sup>		Max. perm. Outgoing Shaft Radial Force <sup>2)</sup>	Moment of inertia Gears	
Type	Type	Gearbox Weight, Approx. kg (lb)	<b>5</b>	<b>10</b>	$n_{G1}$	$M_{G2}$ where $i = 5$	$M_{G2}$ where $i = 10$	$F_r$	$J_G$ where $i = 5/10$ $10^{-4} \text{ kgm}^2 (\text{lb}_f\text{-in-s}^2)$
			○	○	rpm	Nm (lb <sub>f</sub> -ft)	Nm (lb <sub>f</sub> -ft)	N (lb <sub>f</sub> )	
1FK7 022	LP 050-M01	0.77 (1.7)	○		8000	11.5 (8.5)	10.5 (7.7)	650 (146.1)	0.059 (0.00005)
1FK7 022	LP 070-M01	1.9 (4.2)	○	○	6000	32 (23.6)	29 (21.4)	1450 (326)	0.28 (0.00025)
1FK7 032			○	○					
1FK7 033			○	○					
1FK7 040	LP 090-M01	4.1 (9)	○	○	6000	80 (59)	72 (53.1)	2400 (540)	1.77 (0.0016)
1FK7 042			○	○					
1FK7 043			○	○					
1FK7 044			○	○					
1FK7 060	LP 120-M01	9 (19.8)	○	○	4800	200 (147.5)	180 (132.8)	4600 (1034.1)	5.42 (0.0048)
1FK7 061			○	○					
1FK7 063			○	○					
1FK7 064			○	○					
1FK7 080	LP 155-M01	17.5 (38.6)	○	○	3600	400 (295)	320 (236)	7500 (1686.1)	25.73 (0.0228)
1FK7 082			○	○					
1FK7 083			○	○					
1FK7 085			○						
1FK7 100			○						
1FK7 101	○								
1FK7 103	○								
1FK7 105	○								

#### Order Code

• Gear shaft with key

**V40** **V42**

#### Continuous duty S1

At the rated speed and rated torque, continuous duty is permissible. The gearbox temperature must not exceed +90 °C (+194 °F).

<b>Planetary Gearbox Single-Stage</b>	Rated Input Speed	Rated Output Torque	
Torsional backlash ≤ 12 arcmin			
Type	$n_{rated1}$	$M_{rated2}$ where $i = 5$	$M_{rated2}$ where $i = 10$
	rpm	Nm (lb <sub>f</sub> -ft)	Nm (lb <sub>f</sub> -ft)
LP 050-M01	4000	5.7 (4.2)	5.2 (3.8)
LP 070-M01	3700	16 (11.8)	15 (11.1)
LP 090-M01	3400	40 (29.5)	35 (25.8)
LP 120-M01	2600	100 (73.8)	90 (66.4)
LP 155-M01	2000	290 (213.9)	170 (125.4)

1) Values for positioning duty S5.

2) With reference to the center of the outgoing shaft at 100 rpm.

# Servo Motors for SIMOVERT MASTERDRIVES

## Gearboxes for 1FT6 Standard Type Motors

### SP Series Planetary Gearbox

#### Overview



1FT6 Motors with Mounted Planetary Gearboxes

1FT6 motors can be combined with planetary gear units to form compact coaxial drive units. The gearboxes are flanged directly to the drive end of the motors.

When selecting the gearboxes, ensure that the permissible speed of the gear unit is not exceeded by the maximum speed of the motor. In the case of high operating frequencies, an allowance must be made for the load factor  $f_2$  (see Planning Guide). The frictional losses of the gearbox must always be taken into account in planning.

The gear units are only available in non-balanced design.

#### Uses/Benefits

- High efficiency > 94% two-stage, > 97% single-stage
- Power transmission from the central sun gear via planetary gears
- No shaft deflections in the planetary gear set due to the symmetrical force distribution
- Very low moment of inertia and hence short acceleration times of the motors
- Output shaft bearings dimensioned for high cantilever and axial loads with preloaded tapered-roller bearings
- The enclosed gear units, which are filled with oil before leaving the factory, are attached to the shaft by means of an integral clamping hub. This requires a keyless motor shaft end and vibration severity grade N in accordance with EN 60034-14. Radial tolerance N in accordance with DIN 42955 is sufficient.
- Operation is possible in all mounting positions.
- The gear units are filled with a high quality synthetic gear oil in viscosity class ISO VG 220 before leaving the factory. The amount of oil they contain is designed for mounting position IM B5. In the case of single-stage gear units in sizes SP 060 to SP 140, the oil volumes are the same for all mounting positions. In the case of sizes SP 180 to SP 240 and all two-stage gear units, different amounts of oil are required for other mounting positions. Please state the mounting position when ordering.
- Output shaft of gear unit exactly coaxial with the motor
- Gear oil sealed off from motor in gearbox
- Small dimensions
- Lightweight
- Degree of protection IP64

#### Integration

The gear units assigned to the individual motors and gear ratios  $i$  available for these motor/gear combinations are listed in the selection table. When making a selection, the maximum permissible input speed of the gearbox must be observed (this is the same as the maximum motor speed).

The motor/gear combinations listed in the selection tables are mainly intended for use as positioning drives (S5). For applications involving continuous operation at high speed, please contact the gear unit manufacturer.

Follow the instructions contained in the Planning Guide when assigning gear units to the motor.

# Servo Motors for SIMOVERT MASTERDRIVES

## Gearboxes for 1FT6 Standard Type Motors

### Single-Stage SP Series Planetary Gearbox

#### Selection and Ordering Data

Ordering data: **1FT6 ...-A.7.-..** **V** **G** **0** **H** **1** **2** **6** **-Z**



Order number of the motor (standard type) with code “-Z” and code for mounting the planetary gearbox assigned to the motor  
Requirement for mounting of planetary gearbox:  
keyless motor shaft and vibration severity grade N

Motor Self-Cooling Type	Planetary Gearbox Single-Stage		Available gear ratios $i =$				Max. permissible input speed $n_{G1}$ rpm	Max. Permiss. Output Torque $M_{G2}$ Nm (lb <sub>f</sub> -ft)	Max. Permiss. Drive Shaft Load $F_r$ N (lb <sub>f</sub> )	Moment of Inertia Gear Unit $J_G$ where $i = 4$ $10^{-4} \text{ kgm}^2$ (lb <sub>f</sub> -in-s <sup>2</sup> )
	Type	Torsional backlash <sup>1)</sup> $\leq 4 \text{ arcmin}$ Gearbox Weight Approx. kg (lb)	4	5	7	10				
1FT6 024	SP 060-MF1	1.5 (3.3)	○	○	○	○	6000	40 (29.5) [32 (23.6) for $i = 10$ ]	2600 (584.5)	0.17 (0.00015)
1FT6 031			○	○	○	○				
1FT6 034			○	○	○	○				
1FT6 034	SP 075-MF1	2.8 (6.2)				○	6000	100 (73.8) [80 (59) for $i = 10$ ]	3800 (854.3)	0.57 (0.0005)
1FT6 041			○	○	○	○				
1FT6 044			○	○	○	○				
1FT6 044	SP 100-MF1	6.2 (13.7)				○	4500	250 (184.4) [200 (147.5) for $i = 10$ ]	6000 (1348.9)	2 (0.0018)
1FT6 061			○	○	○	○				
1FT6 062			○	○	○	○				
1FT6 064			○	○	○	○				
1FT6 081	SP 140-MF1	11.5 (25.4)	○	○	○	○	4000	500 (368.8) [400 (295) for $i = 10$ ]	9000 (2023.3)	8.4 (0.0074)
1FT6 082			○	○	○	○				
1FT6 084			○	○	○	○				
1FT6 086			○	○	○	○				
1FT6 086	SP 180-MF1	27 (59.6)				○	3500	1100 (811.4) [880 (649.1) for $i = 10$ ]	14000 (3147.3)	30.6 (0.0271)
1FT6 102			○	○	○	○				
1FT6 105			○	○	○	○				
1FT6 108			○	○	○	○				
1FT6 105	SP 210-MF1	53 (116.9)				○	2500	1900 (1401.4) [1520 (1121.2) for $i = 10$ ]	18000 (4046.6)	75.8 (0.0671)
1FT6 108						○				
1FT6 132			○	○	○					
1FT6 134			○	○	○					
1FT6 136	○	○	○							
1FT6 132	SP 240-MF1	80 (176.4)				○	2200	2720 (2006.3)	27000 (6069.9)	146.3 (0.1295)
1FT6 134						○				
1FT6 136						○				

#### Order codes

• Gear shaft with key	<b>V02</b>	<b>V03</b>	<b>V05</b>	<b>V09</b>
• Gear shaft without key	<b>V22</b>	<b>V23</b>	<b>V25</b>	<b>V29</b>

1) For SP 060 and SP 075:  $\leq 6 \text{ arcmin}$ .

2) Guide values for maximum permissible drive shaft load in center of shaft at a speed of  $n_{G2} = 300 \text{ rpm}$ .  
Axial load  $F_a = 0.5 \times F_r$  for SP 060 to SP 180.  $F_a = F_r$  for SP 210 and SP 240.

# Servo Motors for SIMOVERT MASTERDRIVES

## Gearboxes for 1FT6 Standard Type Motors

### Two-Stage SP Series Planetary Gearbox

#### Selection and Ordering Data

Ordering data: **1FT6 ...-A.7.-..** **V** **G** **H** **0** **1** **2** **6** **-Z**



Order No. of the motor (standard type) with code “-Z” and code for mounting the planetary gearbox assigned to the motor  
Requirement for mounting of planetary gearbox:  
keyless motor shaft and vibration severity grade N

Motor Self-Cooling Type	Planetary Gearbox Two-Stage Torsional backlash <sup>1)</sup> ≤ 6 arcmin		Available gear ratios <i>i</i> =					Max. permissible input speed $n_{G1}$ rpm	Max. Permiss. Output Torque $M_{G2}$ Nm (lb <sub>f</sub> -ft)	Max. Permiss. Drive Shaft Load <sup>2)</sup> $F_r$ N (lb <sub>f</sub> )	Moment of Inertia Gear Unit $J_G$ where <i>i</i> = 16 10 <sup>-4</sup> kgm <sup>2</sup> (lb <sub>f</sub> -in-s <sup>2</sup> )
	Type	Gearbox Weight Approx. kg (lb)	16	20	28	40	50				
1FT6 024	SP 075-MF2	3.1 (6.8)	<input type="radio"/>	<input type="radio"/>	<input type="radio"/>	<input type="radio"/>	<input type="radio"/>	6000	100 (73.8)	3800 (854.3)	0.52 (0.0005)
1FT6 031			<input type="radio"/>	<input type="radio"/>	<input type="radio"/>	<input type="radio"/>	<input type="radio"/>				
1FT6 034			<input type="radio"/>	<input type="radio"/>	<input type="radio"/>	<input type="radio"/>	<input type="radio"/>				
1FT6 034	SP 100-MF2	7.1 (15.7)	<input type="radio"/>	<input type="radio"/>	<input type="radio"/>	<input type="radio"/>	<input type="radio"/>	4500	250 (184.4)	6000 (1348.9)	1.7 (0.0015)
1FT6 041			<input type="radio"/>	<input type="radio"/>	<input type="radio"/>	<input type="radio"/>	<input type="radio"/>				
1FT6 044			<input type="radio"/>	<input type="radio"/>	<input type="radio"/>	<input type="radio"/>	<input type="radio"/>				
1FT6 061			<input type="radio"/>	<input type="radio"/>	<input type="radio"/>	<input type="radio"/>	<input type="radio"/>				
1FT6 062			<input type="radio"/>	<input type="radio"/>	<input type="radio"/>	<input type="radio"/>	<input type="radio"/>				
1FT6 062			<input type="radio"/>	<input type="radio"/>	<input type="radio"/>	<input type="radio"/>	<input type="radio"/>				
1FT6 041	SP 140-MF2	14.5 (32)	<input type="radio"/>	<input type="radio"/>	<input type="radio"/>	<input type="radio"/>	<input type="radio"/>	4000	500 (368.8)	9000 (2023.3)	4.4 (0.0039)
1FT6 044			<input type="radio"/>	<input type="radio"/>	<input type="radio"/>	<input type="radio"/>	<input type="radio"/>				
1FT6 061			<input type="radio"/>	<input type="radio"/>	<input type="radio"/>	<input type="radio"/>	<input type="radio"/>				
1FT6 062			<input type="radio"/>	<input type="radio"/>	<input type="radio"/>	<input type="radio"/>	<input type="radio"/>				
1FT6 064			<input type="radio"/>	<input type="radio"/>	<input type="radio"/>	<input type="radio"/>	<input type="radio"/>				
1FT6 062	SP 180-MF2	29 (63.9)	<input type="radio"/>	<input type="radio"/>	<input type="radio"/>	<input type="radio"/>	<input type="radio"/>	4000	1100 (811.4)	14000 (3147.3)	5.5 (0.0049)
1FT6 064			<input type="radio"/>	<input type="radio"/>	<input type="radio"/>	<input type="radio"/>	<input type="radio"/>				
1FT6 081			<input type="radio"/>	<input type="radio"/>	<input type="radio"/>	<input type="radio"/>	<input type="radio"/>				
1FT6 082			<input type="radio"/>	<input type="radio"/>	<input type="radio"/>	<input type="radio"/>	<input type="radio"/>				
1FT6 084			<input type="radio"/>	<input type="radio"/>	<input type="radio"/>	<input type="radio"/>	<input type="radio"/>				
1FT6 086			<input type="radio"/>	<input type="radio"/>	<input type="radio"/>	<input type="radio"/>	<input type="radio"/>				
1FT6 082	SP 210-MF2	48 (105.8)	<input type="radio"/>	<input type="radio"/>	<input type="radio"/>	<input type="radio"/>	<input type="radio"/>	3500	1900 (1401.4)	18000 (4046.6)	34.5 (0.0305)
1FT6 084			<input type="radio"/>	<input type="radio"/>	<input type="radio"/>	<input type="radio"/>	<input type="radio"/>				
1FT6 086			<input type="radio"/>	<input type="radio"/>	<input type="radio"/>	<input type="radio"/>	<input type="radio"/>				
1FT6 102			<input type="radio"/>	<input type="radio"/>	<input type="radio"/>	<input type="radio"/>	<input type="radio"/>				
1FT6 105			<input type="radio"/>	<input type="radio"/>	<input type="radio"/>	<input type="radio"/>	<input type="radio"/>				
1FT6 084	SP 240-MF2	70 (154.3)	<input type="radio"/>	<input type="radio"/>	<input type="radio"/>	<input type="radio"/>	<input type="radio"/>	3500	3400 (2507.8)	27000 (6069.9)	43.1 (0.0381)
1FT6 086			<input type="radio"/>	<input type="radio"/>	<input type="radio"/>	<input type="radio"/>	<input type="radio"/>				
1FT6 102			<input type="radio"/>	<input type="radio"/>	<input type="radio"/>	<input type="radio"/>	<input type="radio"/>				
1FT6 105			<input type="radio"/>	<input type="radio"/>	<input type="radio"/>	<input type="radio"/>	<input type="radio"/>				
1FT6 108			<input type="radio"/>	<input type="radio"/>	<input type="radio"/>	<input type="radio"/>	<input type="radio"/>				

#### Order codes

• Gear shaft with key	<b>V12</b>	<b>V13</b>	<b>V15</b>	<b>V16</b>	<b>V17</b>
• Gear shaft without key	<b>V32</b>	<b>V33</b>	<b>V35</b>	<b>V36</b>	<b>V37</b>

# Servo Motors for SIMOVERT MASTERDRIVES

## Gearboxes for 1PH7 Motors

Two-Speed Gear-Change Gearbox  
(Manufactured by ZF)

### Overview



Cross-Section of Planetary Gearbox

Gear-change gearboxes increase the drive torque at low motor speeds and expand the band of constant power output available from the asynchronous servo motor.

### Technical Features of the Two-Speed Gearbox

- Drive power up to 100 kW (134 HP)
- Constant power band on drive axis up to 1:24
- Bidirectional
- Motor sizes SH 100 to SH 225
- Types IM B35 and IM V15 (IM V36 on request)
- Gearbox efficiency > 95%
- Instead of V-belts, the power output can also be transmitted from the gear drive output shaft by a spur gear pinion (available on request) or coaxially by means of a flexible coupling.

### Design, Method of Operation

These 2-speed gearboxes have a planetary design. The central sun gear distributes the power to several planet wheels which revolve around it. The outstanding advantage of this design is its compactness. The gear-changing device, a splined sleeve that moves axially, is of form-fit design.

Position 1:  
Gear ratio  $i_1 = 4$ .

Position 2:  
Gear ratio  $i_2 = 1$ .

The motor is flanged onto the gearbox via an adapter ring. The AC motor must be suitably prepared for mounting.

For shaft heights of over 160, motors of types IM B35 and IM V15 must be supported free from stress on the non-drive end.

Any cantilever forces imported into the gearbox have to be borne by the gearbox and transmitted to the machine base.

The motors for all 2K gearboxes must be full-key balanced with fitted key. Because the 2K 120, 2K 250, 2K 300 gearboxes are enclosed, the motor flange is adequately sealed in the standard version.

Vertical mounting positions for the IM V15 and IM V36 require circulating-oil lubrication of the gearboxes.

The standard version of the gearboxes up to and including the 2K 300 has a maximum torsional backlash of 30 angular minutes (measured at the gearbox output). The gear switch position has virtually no effect on the torsional backlash. Various special models are available on request.

- Reduced backlash with special features: max. 20'
- Reduced backlash for high performance: max. 15'

The power unit (i.e. the motor and gearbox) is supplied with vibration severity grade R according to EN 60034-14 (IEC 60034-14). This is also the case when the motor is ordered with grade S.

The belt pulley<sup>1)</sup> should be of the cup wheel type. For mounting the pulley, the output shaft on the gearbox has a flange with an external centering spigot and tapped holes for easy fitting and removal of the pulley.

### Integration

The 1PH motors can also be supplied with flange-mounted planetary gearboxes. The motor-gearbox unit is tested for correct functioning. The complete drive unit - that is, 1PH7 or 1PH4 motor with mounted ZF gearbox, can be directly ordered from Siemens:

#### Siemens AG

Industrial Solutions and Services  
Attention: Mr. Britz  
Im Schiffelland 10, D-66386 St. Ingbert, Germany  
Telefax: +49(0)6894-891-112  
E-mail: hans-peter.britz@siemens.com

The following details must be specified with the order:

Ordering example for 1PH4 motor:

**Complete motor with gearbox**  
**1PH4 133 - 4NF56 - Z**  
**K00**  
**2LG4 315-3FD11**

Ordering example for 1PH7 motor:

**Complete motor with gearbox**  
**1PH7 186-2NF03-0BC2**  
**2LG4 260-1JD21**

1) Not included.



# Servo Motors for SIMOVERT MASTERDRIVES

## Gearboxes for 1PH7 Motors

### Two-Speed Gear-Change Gearbox (Manufactured by ZF)

#### Technical Data

Motor Shaft Height	Gears Type	Order No.	Permiss. Max. Speed <sup>1)</sup> $n_{max}$	Permissible Rated Torque (S1 Duty)			Permissible Maximum Torque (S6 60% Duty)			Moment of inertia Gears		Gearbox Weight Approx.
				Drive	Output		Drive	Output		Output $i_2 = 1$	Output $i_1 = 4$	
					$i_2 = 1$	$i_1 = 4$		$i_2 = 1$	$i_1 = 4$			
SH			rpm	Nm (lb <sub>f</sub> -ft)	Nm (lb <sub>f</sub> -ft)	Nm (lb <sub>f</sub> -ft)	Nm (lb <sub>f</sub> -ft)	Nm (lb <sub>f</sub> -ft)	Nm (lb <sub>f</sub> -ft)	kgm <sup>2</sup> (lb <sub>f</sub> -in-s <sup>2</sup> )	kgm <sup>2</sup> (lb <sub>f</sub> -in-s <sup>2</sup> )	kg (lb)
100	2K 120	2LG4 312 - . . .	8000	120 (88.5)	120 (88.5)	480 (354)	140 (103.3)	140 (103.3)	560 (413.1)	0.0110 (0.0973)	0.0114 (0.1009)	30 (66.2)
132	2K 250	2LG4 315 - . . .	6300	250 (184.4)	250 (184.4)	1000 (737.6)	400 (295)	400 (295)	1600 (1180.2)	0.0270 (0.2389)	0.0570 (0.5044)	62 (136.7)
160	2K 300	2LG4 320 - . . .	6300	300 (221.3)	300 (221.3)	1200 (885.1)	400 (295)	400 (295)	1600 (1180.2)	0.0270 (0.2389)	0.0570 (0.5044)	70 (154.4)
180	2K 800	2LG4 250 - . . .	5000	800 (590.1)	800 (590.1)	3200 (2360.3)	900 (663.8)	900 (663.8)	3600 (2655.4)	0.1956 (1.781)	0.1766 (1.5629)	110 (242.6)
	2K 801	2LG4 260 - . . .										
225	2K 802	2LG4 270 - . . .	On Request									

For additional technical data and configuration notes (e.g. lubrication, heating, examples), refer to ZF (Zahnradfabrik Friedrichshafen) Catalog no. 4161 750 002 a. The key data for motor and gearbox must be taken into account when dimensioning the complete drive unit.

For example, the rated torque must be reduced to 300 Nm (2655 lb<sub>f</sub>-in) for AC motor 1PH4 168 oder 1PH7 167-2.B. For motors of size 132, note that the maximum permissible speed of the 2K 250 gearbox with normal lubrication is 6300 rpm.

The use of a gearbox permits the constant power band to be greatly expanded.

#### Key

$n_{rated}$	Rated speed
$n_{rated}'$	Rated speed with two-speed gearbox
$n_{max}$	Maximum permissible speed
$P_N$	Rated output and constant output of AC motor in speed range of $n_{rated}$ to $n_{max}$ and $n_{rated}'$ to $n_{max}$
$M$	Torque

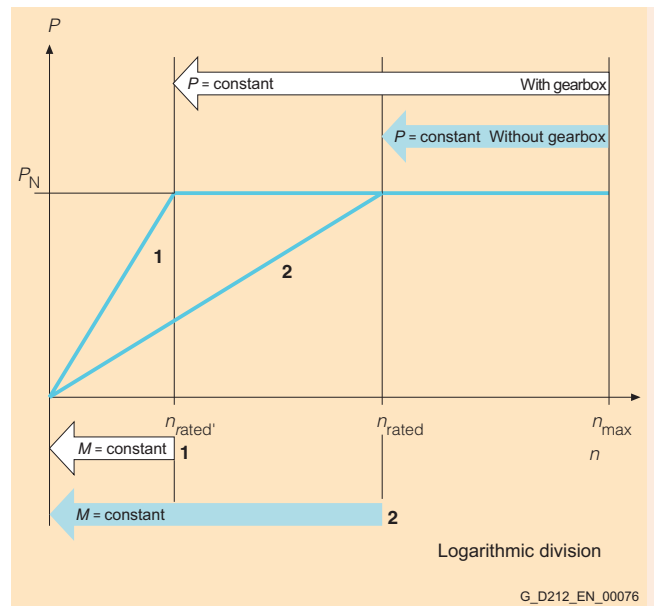

Speed-Output Diagram

1) Higher drive speeds are allowed for gear ratios in some instances with oil-cooled gearboxes (refer to the ZF Catalog).

# Servo Motors for SIMOVERT MASTERDRIVES

## Gearboxes for 1PH7 Motors

Two-Speed Gear-Change Gearbox  
(Manufactured by ZF)

### Selection and Ordering Data

Type of construction Complete Unit	Output Shaft Dimension $D_2$ (See Technical Documentation) mm (in)	2-Speed Gearbox (Standard Version) <sup>1)</sup> Gear stage $i_1 = 4$ Order No.	ZF identifier
<b>For 1PH7 10./1PH4 10. Motors</b>			
IM B5/B35/V1/V15	100 (3.94)	<b>2LG4 312-3CC31</b>	2K 120
<b>For 1PH7 13./1PH4 13. Motors</b>			
IM B5/B35	118 (4.66)	<b>2LG4 315-3FD11</b>	2K 250
IM V1/V15	118 (4.66)	<b>2LG4 315-3FC11</b>	2K 250
<b>For 1PH7 16./1PH4 16. Motors</b>			
IM B35	130 (5.12)	<b>2LG4 320-3JD11</b>	2K 300
IM V15	130 (5.12)	<b>2LG4 320-3JC11</b>	2K 300
<b>For 1PH7 184 Motors</b>			
IM B35, IM V15	180 (7.09)	<b>2LG4 250-1JC11</b>	2K 800
<b>For 1PH7 186 Motors</b>			
IM B35, IM V15	180 (7.09)	<b>2LG4 260-1JC21</b>	2K 801

4

1) Special versions, such as gearboxes with different torsional backlash, or other ratios ( $i = 3.17$  or  $i = 5.5$ ), are available on request.

# Servo Motors for SIMOVERT MASTERDRIVES

## Gearboxes for 1PH7 Motors

Notes

4



# MOTION-CONNECT Cables and Connections

# 5



<b>5/2</b>	<b>General</b>
<b>5/6</b>	<b>Power Cables</b>
<b>5/11</b>	<b>Signal Cables</b>
<b>5/17</b>	<b>Length Codes</b>



# Servo Motors for SIMOVERT MASTERDRIVES

## MOTION-CONNECT Cables and Connections

### General information

#### Overview

MOTION-CONNECT cables can be used in a wide range of processing and production machines.

These power and signal cables can be ordered by the meter and as cable assemblies.

MOTION-CONNECT comprises the following cable types:

- **MOTION-CONNECT 500**, the solution primarily for fixed installation.
- **MOTION-CONNECT 500 PLUS** is suitable for drag chains, can withstand mineral-based oils (except biological oils and cutting oil) and is therefore especially well suited for wood-working machines, printing machines, and simple tooling machines. The current MOTION-CONNECT 500 signal cables already satisfy the requirements of MOTION-CONNECT 500 PLUS, such that no new type is required for signal cables.
- **MOTION-CONNECT 700**, the optimal addition for linear motors and machines with stringent mechanical requirements.
- **MOTION-CONNECT 800** satisfies all requirements for use in drag chains in processing and production machines.

#### Uses/Benefits

MOTION-CONNECT cable assemblies offer the following benefits:

- High quality, meaning safety and proper functioning
- Cost savings for logistics, construction, assembly, and purchasing
- Defect repair by Siemens
- Cable supply in exact metered lengths (intermediate lengths on request).

#### Application

When specifying cable lengths for the systems and applications in this catalog, the maximum permissible cable lengths indicated in the technical data must be not be exceeded. Malfunctions can occur if longer cables are used.

In this case, Siemens AG provides no warranty for correct transmission of signals or power.

These cables are not suitable for outdoor use.

Degree of protection of enclosed and connected power and signal cable assemblies and extension cables: IP67



# Servo Motors for SIMOVERT MASTERDRIVES

## MOTION-CONNECT Cables and Connections

### General information

#### Technical Data

These technical data are applicable only for simple bends with horizontal travel distances of up to 16.4 ft (5 m).

Cables	MOTION-CONNECT 500 PLUS Type 6FX5 10. – ...	MOTION-CONNECT 500 Type 6FX5 00. – ...	MOTION-CONNECT 700 Type 6FX7 00. – ...	MOTION-CONNECT 800 Type 6FX8 00. – ...
<b>Approvals</b>				
Power/signal cables				
• VDE <sup>1)</sup>	Yes	Yes	Yes	Yes
• cUL or UL/CSA	UL758-CSA-C22.2-N.210.2-M90	UL758-CSA-C22.2-N.210.2-M90	UL758-CSA-C22.2-N.210.2-M90	UL758-CSA-C22.2-N.210.2-M90
• UL-CSA File Nr. <sup>2)</sup>	Yes	Yes	Yes	Yes
<b>Electrical Data in Accordance with DIN VDE 0472</b>				
Rated voltage				
• Power cable $U_b/U$				
– Supply cores	600 V/1000 V	600 V/1000 V	600 V/1000 V	600 V/1000 V
– Signal cores	24 V (VDE) 1000 V (UL/CSA)	24 V (VDE) 1000 V (UL/CSA)	24 V (VDE) 1000 V (UL/CSA)	24 V (VDE) 1000 V (UL/CSA)
• Signal cable	–	30 V	30 V	30 V
Test voltage (eff)				
• Power cable				
– Supply cores	4 kV	4 kV	4 kV	4 kV
– Signal cores	2 kV	2 kV	2 kV	2 kV
• Signal cable	–	500 V	500 V	500 V
<b>Operating Temperature</b>				
at the surface				
• Fixed	–20 °C to +80 °C (–4 °F to +176 °F)	–20 °C to +80 °C (–4 °F to +176 °F)	–50 °C to +80 °C (–58 °F to +176 °F)	–50 °C to +80 °C (–58 °F to +176 °F)
• Moving	0 °C to +60 °C (+32 °F to +140 °F)	0 °C to +60 °C (+32 °F to +140 °F)	–20 °C to +60 °C (–4 °F to +140 °F)	–20 °C to +60 °C (–4 °F to +140 °F)
<b>Mechanical Data</b>				
Max. tensile stress on power/signal cables:				
• Fixed	50 N/mm <sup>2</sup> (7552 lb <sub>f</sub> /in <sup>2</sup> )	50 N/mm <sup>2</sup> (7552 lb <sub>f</sub> /in <sup>2</sup> )	50 N/mm <sup>2</sup> (7552 lb <sub>f</sub> /in <sup>2</sup> )	50 N/mm <sup>2</sup> (7552 lb <sub>f</sub> /in <sup>2</sup> )
• Moving	20 N/mm <sup>2</sup> (2900 lb <sub>f</sub> /in <sup>2</sup> )	20 N/mm <sup>2</sup> (2900 lb <sub>f</sub> /in <sup>2</sup> )	20 N/mm <sup>2</sup> (2900 lb <sub>f</sub> /in <sup>2</sup> )	20 N/mm <sup>2</sup> (2900 lb <sub>f</sub> /in <sup>2</sup> )
Minimum bending radius				
• Power cable				
– Fixed	5 x $D_{max}$	5 x $D_{max}$	4 x $D_{max}$	6 x $D_{max}$
– Moving	See "Power Cables"	See "Power Cables"	See "Power Cables"	See "Power Cables"
• Signal Cable				
– Fixed	–	60 mm (2.36 in)	60 mm (2.36 in)	60 mm (2.36 in)
– Moving	–	100 mm (3.94 in)	95 mm (3.74 in)	100 mm (3.94 in)
Torsional stress				
	Absolute 30°/m	Absolute 30°/m	Absolute 30°/m	Absolute 30°/m
Bend				
• Power cables				
– 1.5 to 6 mm <sup>2</sup>	2 million	100,000	10 million	10 million
– 10 to 185 mm <sup>2</sup>	–	100,000	10 million	3 million
• Signal Cables	–	2 million	10 million	10 million
Traversing speed				
• Power cables				
– 1.5 to 6 mm <sup>2</sup>	180 m/min (591 ft/min)	30 m/min (98 ft/min)	200 m/min (656 ft/min)	180 m/min (591 ft/min)
– 10 to 50 mm <sup>2</sup>	–	30 m/min (98 ft/min)	200 m/min (656 ft/min)	100 m/min (328.2 ft/min)
• Signal Cables	–	180 m/min (591 ft/min)	200 m/min (656 ft/min)	180 m/min (591 ft/min)
Acceleration				
• Power cables	5 m/s <sup>2</sup> (16 ft/s <sup>2</sup> )	2 m/s <sup>2</sup> (6.6 ft/s <sup>2</sup> )	30 m/s <sup>2</sup> (98 ft/s <sup>2</sup> )	5 m/s <sup>2</sup> (5 m), 10 m/s <sup>2</sup> (2.5 m) [16 ft/s <sup>2</sup> (16 ft), 33 ft/s <sup>2</sup> (8.2 ft)]
• Signal Cables	–	5 m/s <sup>2</sup> (16 ft/s <sup>2</sup> )	30 m/s <sup>2</sup> (98 ft/s <sup>2</sup> )	5 m/s <sup>2</sup> (5 m), 10 m/s <sup>2</sup> (2.5 m) [16 ft/s <sup>2</sup> (16 ft), 33 ft/s <sup>2</sup> (8.2 ft)]

1) The relevant registration number is imprinted on the cable sheath (power cables only).

2) The file number is imprinted on the cable sheath.

# Servo Motors for SIMOVERT MASTERDRIVES

## MOTION-CONNECT Cables and Connections

### General information

#### Technical Data

Cables	MOTION-CONNECT 500 PLUS Type 6FX5 10. – ...	MOTION-CONNECT 500 Type 6FX5 00. – ...	MOTION-CONNECT 700 Type 6FX7 00. – ...	MOTION-CONNECT 800 Type 6FX8 00. – ...
<b>Chemical Data</b>				
Insulation material	CFC/silicone-free	CFC/silicone-free	CFC/halogen/silicone-free DIN 472 815/IEC 60754-1	CFC/halogen/silicone-free DIN 472 815/IEC 60754-1
Oil resistant	DIN EN 60811-1-1/-2-1 (only mineral oil)	VDE 0472, Part 803 Test mode B (only mineral oil)	VDE 0472, Part 803 Test mode B	VDE 0472, Part 803 Test mode B
Outer shield	PVC	PVC	PUR, DIN VDE 0282, Part 10	PUR, DIN VDE 0282, Part 10
• Power cable	DESINA color orange RAL 2003	DESINA color orange RAL 2003	DESINA color orange RAL 2003	DESINA color orange RAL 2003
• Signal cable	–	DESINA color green RAL 6018	DESINA color green RAL 6018	DESINA color green RAL 6018
Flame-retardant	IEC 60332.1	IEC 60332.1	IEC 60332.1	IEC 60332.1

# Servo Motors for SIMOVERT MASTERDRIVES

## MOTION-CONNECT Cables and Connections

### General information

#### Function

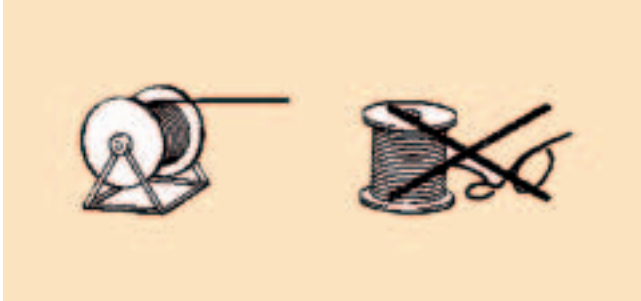

When removing cable from its drum, you must ensure that it does not become twisted, i. e. cable must be rolled out and must never be looped and pulled off over the drum edge.

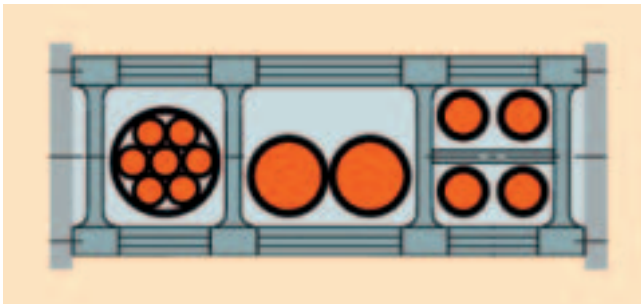

To ensure a long lifecycle for the drag chain and cables, cables made of different materials must be laid with a separating web in the drag chain. These webs must be filled evenly to ensure that the position of the cables does not shift during operation. To the extent possible, the cables should be distributed symmetrically according to their weight and dimensions. Cables with very different outer diameters should be separated by webs.

When placing cable assemblies in the drag chain, **do not** pull on the connector or else you might damage the strain relief or cable terminal.

Cables in the drag chain must be unattached and movable.

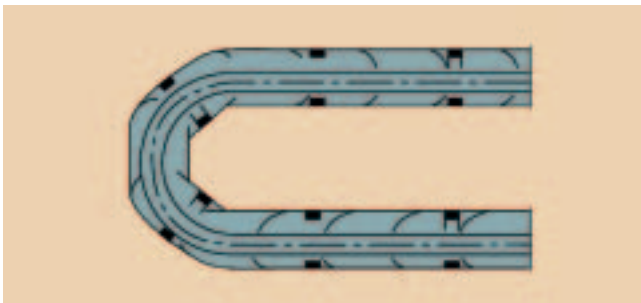

Cables must be able to move without constraint, especially in the bending radii of the chain. The defined minimum bending radii must be maintained.

The cable fixtures must be placed in a "dead" zone at each end, suitably far away from the end points of the moving parts.

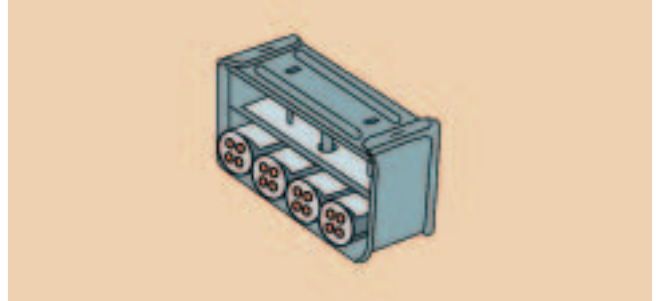

Our cables are tested in a drag chain. A strain relief assembly is applied to the cables at the movable ends of the drag chain; this is done over a large area of the sheath surface without crimping the cable construction.

The assembly instructions of the drag chain manufacturer must always be followed when laying cables, while taking into account the requirements of the plant design.

#### Notes:

If, for example, cable assemblies are installed in a drag chain and the connector hinders installation, preassembled cables without an integral connector (signal and power cables) are also available and can be used instead. With this type of cable, the contacts are crimped, and the connector housing is enclosed separately in the cable shipment. After laying the cables, the customer then assembles the connector housing.

When laying cables, always comply with the specifications of the drag chain manufacturer.

**Our cables are approved for a horizontal traveling distance of up to 5 m (16.4 ft).**

If the cables are subject to vibration stress or if the cable entries are horizontal or vertical, we always recommend an additional cable attachment if a portion of the cable hangs freely or is not guided between the strain relief and the drag chain. To prevent the machine vibrations from being transferred to the connector, the cable attachment should be connected to the moving part on which the motor is installed.



# Servo Motors for SIMOVERT MASTERDRIVES

## MOTION-CONNECT Cables and Connections

### Power Cables for Motors

#### Overview



MOTION-CONNECT power cables are used to connect synchronous and asynchronous motors.

The high quality of MOTION-CONNECT power cable assemblies means proper functioning and safety for you.

MOTION-CONNECT power cables have integral connectors on one or both sides, depending on their design.

**Note:**

The maximum cable length (for base cable and extensions) must not be exceeded. The maximum permissible length is reduced by 2 m (6.6 ft) for each break. All power cables are also available with crimped contacts and loose connector housing on request.

Loose motor-side connector housing

Order No. 6FX. 042-5...-1...

Loose module-side connector housing

Order No. 6FX. 012-5...-1...

#### Selection and Ordering Data

##### MOTION-CONNECT Power Cables *without Brake Cores*

No. of Cores x Cross Section mm <sup>2</sup>	Connector Size, Motor Side	Cable Assembly for 1FT/1FK Motors Order No.	D <sub>max</sub> 6FX50 mm (in)	D <sub>max</sub> 6FX51 mm (in)	D <sub>max</sub> 6FX8 mm (in)	Cut-to-Length Cable <sup>2)</sup> for 1PH/1PL6/ 1FW3 Motors Order No.	Weight (Cut to Length)			Smallest Permiss. Bending Radius <sup>1)</sup>		
							6FX50 kg/m (lb/ft)	6FX51 kg/m (lb/ft)	6FX8 kg/m (lb/ft)	6FX50 mm (in)	6FX51 mm (in)	6FX8 mm (in)
4x1.5	1	<b>6FX 002 – 5CA01 – ....</b>	8.4 (0.33)	10.1 (0.4)	10.4 (0.41)	<b>6FX 008 – 1BB11 – ....</b>	0.18 (0.12)	0.16 (0.11)	0.16 (0.11)	155 (6.1)	105 (4.13)	100 (3.94)
	1.5	<b>6FX 002 – 5CA21 – ....</b>										
4x2.5	1	<b>6FX 002 – 5CA11 – ....</b>	10 (0.39)	11.5 (0.45)	12.1 (0.48)	<b>6FX 008 – 1BB21 – ....</b>	0.24 (0.16)	0.24 (0.16)	0.24 (0.16)	180 (7.09)	115 (4.53)	120 (4.72)
	1.5	<b>6FX 002 – 5CA31 – ....</b>										
4x4	1.5	<b>6FX 002 – 5CA41 – ....</b>	11.4 (0.45)	13.3 (0.52)	13.2 (0.52)	<b>6FX 008 – 1BB31 – ....</b>	0.32 (0.22)	0.31 (0.21)	0.31 (0.21)	210 (8.27)	135 (5.31)	130 (5.12)
4x6	1.5	<b>6FX 002 – 5CA51 – ....</b>	13.6 (0.54)	15.5 (0.61)	16 (0.63)	<b>6FX 008 – 1BB41 – ....</b>	0.46 (0.31)	0.44 (0.3)	0.43 (0.29)	245 (9.65)	160 (6.3)	170 (6.69)
4x10	1.5	<b>6FX 002 – 5CA61 – ....</b>	20 (0.79)		19.4 (0.76)	<b>6FX 008 – 1BB51 – ....</b>	0.73 (0.49)		0.63 (0.42)	360 (14.17)		210 (8.27)
	3	<b>6FX 002 – 5CA13 – ....</b>										
4x16	3	<b>6FX 002 – 5CA23 – ....</b>	24.2 (0.95)		23.6 (0.93)	<b>6FX 008 – 1BB61 – ....</b>	1.10 (0.74)		0.95 (0.64)	440 (17.32)		260 (10.24)
4x25	3	–	28 (1.1)			<b>6FX 5 008 – 1BB25 – ....</b>	1.42 (0.95)			505 (19.88)		
4x35	–	–	31.5 (1.24)			<b>6FX 5 008 – 1BB35 – ....</b>	1.87 (1.26)			570 (22.44)		
4x50	–	–	38 (1.5)			<b>6FX 5 008 – 1BB50 – ....</b>	3.42 (2.3)			685 (26.97)		
4x70	–	–	42.6 (1.68)			<b>6FX 5 008 – 1BB70 – ....</b>	4.12 (2.77)			770 (30.31)		
4x95	–	–	51.7 (2.04)			<b>6FX 5 008 – 1BB05 – ....</b>	4.48 (3.01)			935 (36.81)		
4x120	–	–	56 (2.2)			<b>6FX 5 008 – 1BB12 – ....</b>	6.11 (4.11)			1010 (39.76)		
4x150	–	–	63 (2.48)			<b>6FX 5 008 – 1BB15 – ....</b>	7.75 (5.21)			1135 (44.69)		
4x185	–	–	66.2 (2.61)			<b>6FX 5 008 – 1BB18 – ....</b>	9.45 (6.35)			1195 (47.05)		

**5 0** MOTION-CONNECT 500  
**5 1** MOTION-CONNECT 500 PLUS  
**8 0** MOTION-CONNECT 800

**5 0**  
**5 1**  
**8 0**

See Length Codes on page 5/17

1) Valid for installation in drag chain.

2) Power cables 4 mm<sup>2</sup> and larger can be ordered by the exact meter up to 100 m (328 ft). Power cables of 1.5 mm<sup>2</sup> and 2.5 mm<sup>2</sup> are supplied in rings or single-use drums of 50 m (164 ft), 100 m (328 ft), 200 m (656 ft), and 500 m (1,641 ft).

# Servo Motors for SIMOVERT MASTERDRIVES

## MOTION-CONNECT Cables and Connections

Power Cables for Motors

### Selection and Ordering Data

#### MOTION-CONNECT Power Cable Assemblies for Ex Motors without Brake Cores

No. of Cores x Cross Section  mm <sup>2</sup>	Plug Con- nectors, Motor/ Module Side	<b>Cable Assembly for 1FS6 Motors</b>  Order No.	$D_{max}$ 6FX50  mm (in)	Weight (Cut to Length)  6FX50 kg/m (lb/ft)	Smallest Permiss. Bending Radius <sup>1)</sup>  6FX50 mm (in)
4x15		<b>6FX 5 0 02 – 5XA00 – ....</b>	10.4 (0.41)	0.16 (0.11)	190 (7.48)
4x2.5		<b>6FX 5 0 02 – 5XA10 – ....</b>	12.1 (0.48)	0.235 (0.16)	220 (8.66)
4x4		<b>6FX 5 0 02 – 5XA20 – ....</b>	13.2 (0.52)	0.300 (0.2)	240 (9.45)
4x6		<b>6FX 5 0 02 – 5XA30 – ....</b>	15.3 (0.6)	0.440 (0.3)	280 (11.02)

MOTION-CONNECT 500 **5 0**

See Length Codes on page 5/17

1) Valid for installation in drag chain.

# Servo Motors for SIMOVERT MASTERDRIVES

## MOTION-CONNECT Cables and Connections

### Power Cables for Motors

#### Selection and Ordering Data

##### MOTION-CONNECT Power Cables with Brake Cores

No. of Cores x Cross Section	Con- nect- or Size, Motor Side	Cable Assembly for 1FT/1FK Motors Order No.	$D_{max}$	$D_{max}$	$D_{max}$	Cut-to-Length Cable <sup>2)</sup> for 1PH/1PL6/ 1FW3 Motors Order No.	Weight (Cut to Length)				Smallest Permiss. Bending Radius <sup>1)</sup>				
			6FX5	6FX7	6FX8		6FX50	6FX51	6FX7	6FX8	6FX50	6FX51	6FX7	6FX8	
mm <sup>2</sup>			mm (in)	mm (in)	mm (in)		kg/m (lb/ft)	kg/m (lb/ft)	kg/m (lb/ft)	kg/m (lb/ft)	mm (in)	mm (in)	mm (in)	mm (in)	
4x1.5 + 2x1.5	1	<b>6FX 002 – 5DA01 – ....</b>	10.8 (0.43)	14.0 (0.55)	12.9 (0.51)	<b>6FX 008 – 1BA11 – ....</b>	0.22 (0.15)	0.26 (0.17)	0.26 (0.17)	0.25 (0.17)	195 (7.68)	135 (5.31)	100 (3.94)	125 (4.92)	
	1.5	<b>6FX 002 – 5DA21 – ....</b>													
4x2.5 + 2x1.5	1	<b>6FX 002 – 5DA11 – ....</b>	12.4 (0.49)	15.2 (0.6)	14.2 (0.56)	<b>6FX 008 – 1BA21 – ....</b>	0.28 (0.19)	0.32 (0.22)	0.33 (0.22)	0.31 (0.21)	225 (8.86)	145 (5.71)	110 (4.33)	140 (5.51)	
	1.5	<b>6FX 002 – 5DA31 – ....</b>													
4x4 + 2x1.5	1.5	<b>6FX 002 – 5DA41 – ....</b>	14 (0.55)	16.6 (0.65)	15.3 (0.6)	<b>6FX 008 – 1BA31 – ....</b>	0.36 (0.24)	0.40 (0.27)	0.43 (0.29)	0.40 (0.27)	255 (10.04)	160 (6.3)	120 (4.72)	150 (5.91)	
	1.5	<b>6FX 002 – 5DA51 – ....</b>	16.1 (0.63)	18.3 (0.72)	17.8 (0.7)	<b>6FX 008 – 1BA41 – ....</b>	0.54 (0.36)	0.50 (0.34)	0.52 (0.35)	0.53 (0.37)	290 (11.42)	170 (6.69)	130 (5.12)	195 (7.68)	
4x10 + 2x1.5	1.5	<b>6FX 002 – 5DA61 – ....</b>	21.7 (0.85)	23.5 (0.93)	20.8 (0.82)	<b>6FX 008 – 1BA51 – ....</b>	0.75 (0.5)		0.79 (0.53)	0.74 (0.5)	395 (15.55)		165 (6.5)	230 (9.06)	
	3	<b>6FX 5 002 – 5DA13 – ....</b>													
4x16 + 2x1.5	3	<b>6FX 002 – 5DA23 – ....</b>	25 (0.98)	26.1 (1.03)	24.7 (0.97)	<b>6FX 008 – 1BA61 – ....</b>	1.10 (0.74)		1.06 (0.71)	1.10 (0.74)	450 (17.72)		185 (7.28)	275 (10.83)	
	3	<b>6FX 002 – 5DA33 – ....</b>	29.4 (1.16)	30.5 (1.2)	27.9 (1.1)	<b>6FX 008 – 1BA25 – ....</b>	1.56 (1.05)		1.52 (1.02)	1.46 (0.98)	530 (20.87)		215 (8.46)	325 (12.8)	
4x35 + 2x1.5	3	<b>6FX 5 002 – 5DA43 – ....</b>	32.6 (1.28)		32.0 (1.26)	<b>6FX 5 008 – 1BA35 – ....</b>	2.01 (1.35)			2.10 (1.41)	590 (23.23)			380 (14.96)	
	3	<b>6FX 8 002 – 5DA43 – ....</b>				<b>6FX 8 008 – 1BA35 – ....</b>									
4x50 + 2x1.5	3	<b>6FX 5 002 – 5DA53 – ....</b>	38.0 (1.47)		35.8 (1.41)	<b>6FX 5 008 – 1BA50 – ....</b>	3.30 (2.22)			2.75 (1.85)	685 (26.97)			420 (16.54)	
	3	<b>6FX 8 002 – 5DA53 – ....</b>				<b>6FX 8 008 – 1BA50 – ....</b>									
		<b>5 0</b>	MOTION-CONNECT 500				<b>5 0</b>								
		<b>5 1</b>	MOTION-CONNECT 500 PLUS				<b>5 1</b>								
		<b>7 0</b>	MOTION-CONNECT 700				<b>7 0</b>								
		<b>8 0</b>	MOTION-CONNECT 800				<b>8 0</b>								

See Length Codes on page 5/17

1) Valid for installation in drag chain.

2) Power cables 4 mm<sup>2</sup> and larger can be ordered by the exact meter up to 100 m (328 ft). Power cables of 1.5 mm<sup>2</sup> and 2.5 mm<sup>2</sup> are supplied in rings or single-use drums of 50 m (164 ft), 100 m (328 ft), 200 m (656 ft), and 500 m (1,641 ft).

# Servo Motors for SIMOVERT MASTERDRIVES

## MOTION-CONNECT Cables and Connections

### Power Cables – Extensions

#### Selection and Ordering Data

##### Power Cables – Extension for 1FT/1FK Motors

No. of Cores x Cross Section	Connector Size	Extensions	Connector Size	Base Cables
		Order No.		Order No.
4x1.5	1	6FX 002 – 5 A05 – ....	1	6FX 002 – 5 A01 – ....
4x2.5	1	6FX 002 – 5 A15 – ....	1	6FX 002 – 5 A11 – ....
4x1.5	1.5	6FX 002 – 5 A28 – ....	1.5	6FX 002 – 5 A21 – ....
4x2.5	1.5	6FX 002 – 5 A38 – ....	1.5	6FX 002 – 5 A31 – ....
4x4	1.5	6FX 002 – 5 A48 – ....	1.5	6FX 002 – 5 A41 – ....
4x6	1.5	6FX 002 – 5 A58 – ....	1.5	6FX 002 – 5 A51 – ....
4x10	1.5	6FX 002 – 5 A68 – ....	1.5	6FX 002 – 5 A61 – ....
4x10	3	6FX 002 – 5 X18 – ....	3	6FX 002 – 5 A13 – ....
4x16	3	6FX 002 – 5 X28 – ....	3	6FX 002 – 5 A23 – ....
4x25	3	6FX 002 – 5 D X38 – ....	3	6FX 002 – 5 D A33 – ....
4x35	3	6FX 5 002 – 5 D X48 – ....	3	6FX 5 002 – 5 D A43 – ....
	3	6FX 8 002 – 5 D X48 – ....	3	6FX 8 002 – 5 D A43 – ....
4x50	3	6FX 5 002 – 5 D X58 – ....	3	6FX 5 002 – 5 D A53 – ....
	3	6FX 8 002 – 5 D X58 – ....	3	6FX 8 002 – 5 D A53 – ....
MOTION-CONNECT 500		5		5
MOTION-CONNECT 700 <sup>1)</sup>		7		7
MOTION-CONNECT 800		8		8
Without brake cores		C		C
With brake cores		D		D

See Length Codes on page 5/17

The power cable and extension combinations shown here are intended only as examples.

##### Replacement Power Connectors

Designation	Core Cross-Section mm <sup>2</sup>	Design	Connector Order No.
Power connector, Size 1 (complete)	1.5 to 2.5	Screw cap, socket External thread, pins	6FX2 003 – 0CA10 6FX2 003 – 1CA10
Power connector, Size 1.5 (complete)	1.5 to 4	Screw cap, socket External thread, pins	6FX2 003 – 0CB10 6FX2 003 – 1CB10
	6 to 10	Screw cap, Socket External thread, pins	6FX2 003 – 0CB20 6FX2 003 – 1CB20
Power connector, Size 3 (housing and insulator) • contacts	10 to 50	Screw cap, Socket External thread, pins	6FX2 003 – 0LU20 6FX2 003 – 0LA20
	5 x 10 + 3 x 1.0 ... 2.5	Socket	6FX2 003 – 8LB10
	5 x 16 + 3 x 1.0 ... 2.5	Socket	6FX2 003 – 8LB16
	5 x 25 + 3 x 1.0 ... 2.5	Socket	6FX2 003 – 8LB25
	5 x 35 + 3 x 1.0 ... 2.5	Socket	6FX2 003 – 8LB35
	5 x 50 + 3 x 1.0 ... 2.5	Socket	6FX2 003 – 8LB50
	5 x 10 + 3 x 1.0 ... 2.5	Pin	6FX2 003 – 8LS10
	5 x 16 + 3 x 1.0 ... 2.5	Pin	6FX2 003 – 8LS16
	5 x 25 + 3 x 1.0 ... 2.5	Pin	6FX2 003 – 8LS25
	5 x 35 + 3 x 1.0 ... 2.5	Pin	6FX2 003 – 8LS35
	5 x 50 + 3 x 1.0 ... 2.5	Pin	6FX2 003 – 8LS50

1) MOTION-CONNECT 700 only in "With Brake Cores" design.

# Servo Motors for SIMOVERT MASTERDRIVES

## MOTION-CONNECT Cables and Connections

### Power Cables Feed-Through/Grounding

#### Overview

##### Flange Assembly

Flanges are used for feed-through and attachment of connectors in control cabinets. Except for right-angle connectors, a flange can be post-assembled on all connectors with a screw cap or an external thread.

##### HF (high-frequency) clamp

To guarantee correct grounding, a ground clamp is optionally available together with the flanges for large-area discharging of high-frequency interference.

#### Dimension Drawings

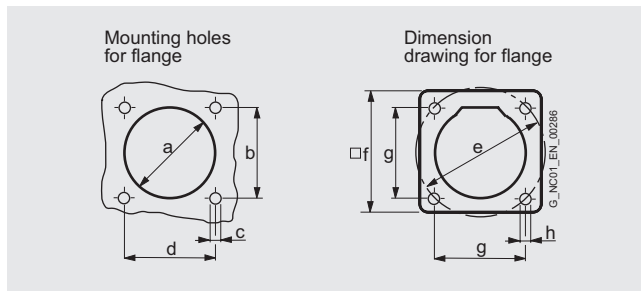

#### Dimensions in mm (in)

Connector Size 1	Connector Size 1.5	Connector Size 3
a = Ø 27.8 (1.1)	a = Ø 46 (1.8)	a = Ø 65 (2.6)
b = 28.3 (1.1)	b = 42.4 (1.7)	b = 75 (3)
c = M3 (4x)	c = M4 (4x)	c = M4 (4x)
d = 28.3 (1.1)	d = 42.4 (1.7)	d = 75 (3)
e = Ø 40 (1.6)	e = Ø 60 (2.4)	e = Ø 63
f = 35 (1.4)	f = 55 (2.2)	f = 85 (2.5)
g = 28.3 (1.1)	g = 42.4 (1.7)	g = 75 (3)
h = Ø 3.2 (0.1)	h = Ø 4.4 (0.2)	h = Ø 1.7 (0.2)

### Power Connectors Current-Carrying Capacity/Correction Factors

#### Overview

##### Current-Carrying Capacity ( $I_z$ ) of PVC insulated Copper Conductors in Accordance with IEC 60204-1: 1997 ++ Corrigen- dum 1998

The IEC 60204-1 current-carrying capacity ( $I_z$ ) of PVC insulated conductors corresponds to Routing Type C under continuous duty and is specified in the table with reference to an ambient temperature of +40 °C (+104 °F). For other ambient temperatures, these values must be adjusted with factors from the "Correction Factors" table. PUR cables are also governed by this standard.

Cross-Section <sup>1)</sup> mm <sup>2</sup>	Current-Carrying Capacity ( $I_z$ ) [A] for Routing Types (See C 1.2)			
	B1	B2	C	E
0.75	7.6	–	–	–
1.0	10.4	9.6	11.7	11.5
1.5	13.5	12.2	15.2	16.1
2.5	18.3	16.5	21	22
4	25	23	28	30
6	32	29	36	37
10	44	40	50	52
16	60	53	66	70
25	77	67	84	88
35	97	83	104	114
50	–	–	123	123
70	–	–	155	155
95	–	–	192	192
120	–	–	221	221
150	–	–	234	262
185	–	–	267	300
Electronics (Pairs)				
0.2	–	–	4.0	4.0
0.3	–	–	5.0	5.0
0.5	–	–	7.1	7.1
0.75	–	–	9.1	9.1

#### Selection and Ordering Data

Designation	Order No.
<b>Flange for:</b>	
• Connector size 1	<b>6FX2 003 – 7BX00</b>
• Connector size 1.5	<b>6FX2 003 – 7CX00</b>
• Connector size 3	<b>6FX2 003 – 7AX00</b>
<b>HF clamp for:</b>	
• Power connector size 1	<b>6FX2 003 – 7FX00</b>
• Power connector size 1.5	<b>6FX2 003 – 7GX00</b>
• Power connector size 3	Not required

#### Correction factors

Ambient Temperature of Air °C (°F)	Correction Factor
30 (86)	1.15
35 (95)	1.08
40 (104)	1.00
45 (113)	0.91
50 (122)	0.82
55 (131)	0.71
60 (140)	0.58

#### Note:

These correction factors are excerpted from IEC 60364-5-523, Table 52-D1.

1)AWG values see Appendix, page A/8.

# Servo Motors for SIMOVERT MASTERDRIVES

## MOTION-CONNECT Cables and Connections

### Signal Cables Feed-Through/Grounding

### Signal Cables

#### Overview



MOTION-CONNECT signal cables are used to connect the encoders of synchronous and asynchronous motors to the converter system.

The high quality of MOTION-CONNECT signal cable assemblies means proper functioning and safety for you. MOTION-CONNECT signal cables have integral connectors on one or both sides, depending on their design.

#### Note:

The maximum cable length (base cables and extensions) must not be exceeded. The maximum permissible length is reduced by 2 m (6.6 ft) for each break. All signal cables are also available with crimped contacts and loose connector housing on request.

Loose motor-side connector housing

Order No.: 6FX. 042-2...-....

Loose module-side connector housing

Order No.: 6FX. 012-2...-....

#### Selection and Ordering Data

##### Signal Cables – Extensions

Extensions Order No.	Base Cables Order No.
6FX 002 – 2AD04 – ....	6FX 002 – 2AD00 – ....
6FX 002 – 2CB54 – ....	6FX 002 – 2CA11 – ....
6FX 002 – 2CA34 – ....	6FX 002 – 2CA31 – ....
6FX 002 – 2CB54 – ....	6FX 002 – 2CC11 – ....
6FX 002 – 2CB54 – ....	6FX 5 002 – 2CD01 – ....
6FX 002 – 2CB54 – ....	6FX 8 002 – 2CD01 – ....
6FX 002 – 2CF04 – ....	6FX 002 – 2CF02 – ....
6FX 002 – 2CB54 – ....	6FX 002 – 2CG00 – ....
6FX 002 – 2AD04 – ....	6FX 002 – 2CH00 – ....
6FX 002 – 2EQ14 – ....	6FX 002 – 2EQ10 – ....
5 MOTION-CONNECT 500	5
7 MOTION-CONNECT 700	7
8 MOTION-CONNECT 800	8

Extension Order No.	Base Cable Order No.
6FX 8 002 – 2CA41 – ....	6FX 8 002 – 2CA21 – ....

The signal cable and extension combinations shown here are intended only as examples.

#### Overview

##### Flange Assembly

Flanges are used for feed-through and attachment of connectors e. g., in control cabinets. Except for right-angle connectors, a flange can be post-assembled on all connectors with a screw cap or an external thread.

##### HF (high-frequency) clamp

To guarantee correct grounding, a ground clamp is optionally available together with the flanges for large-area discharging of high-frequency interference.

#### Dimension Drawings

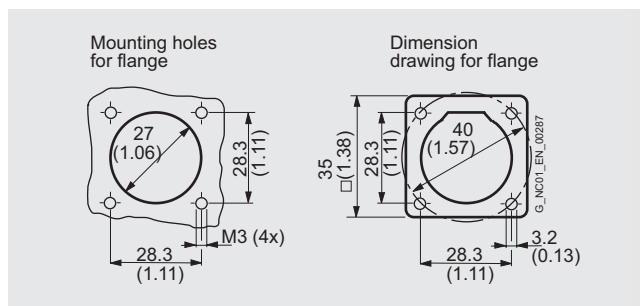

#### Selection and Ordering Data

Designation	Order No.
Flange for signal connector	6FX2 003 – 7DX00
HF clamp for all signal connectors	6FX2 003 – 7FX00

#### Selection and Ordering Data

##### Signal Cables for Ex Motors

Base Cables Order No.
6FX 5 002 – 2XQ10 – .... for absolute encoders, EnDat
6FX 5 002 – 2XA00 – .... for incremental encoders, sin/cos 1 V <sub>pp</sub>
6FX 5 002 – 1XA04 – .... for PTC thermistors
5 MOTION-CONNECT 500

5

# Servo Motors for SIMOVERT MASTERDRIVES

## MOTION-CONNECT Cables and Connections

### Signal Cables

#### SIMOVERT MASTERDRIVES Motion Control and Vector Control Connection Overviews

##### SIMOVERT MASTERDRIVES Motion Control

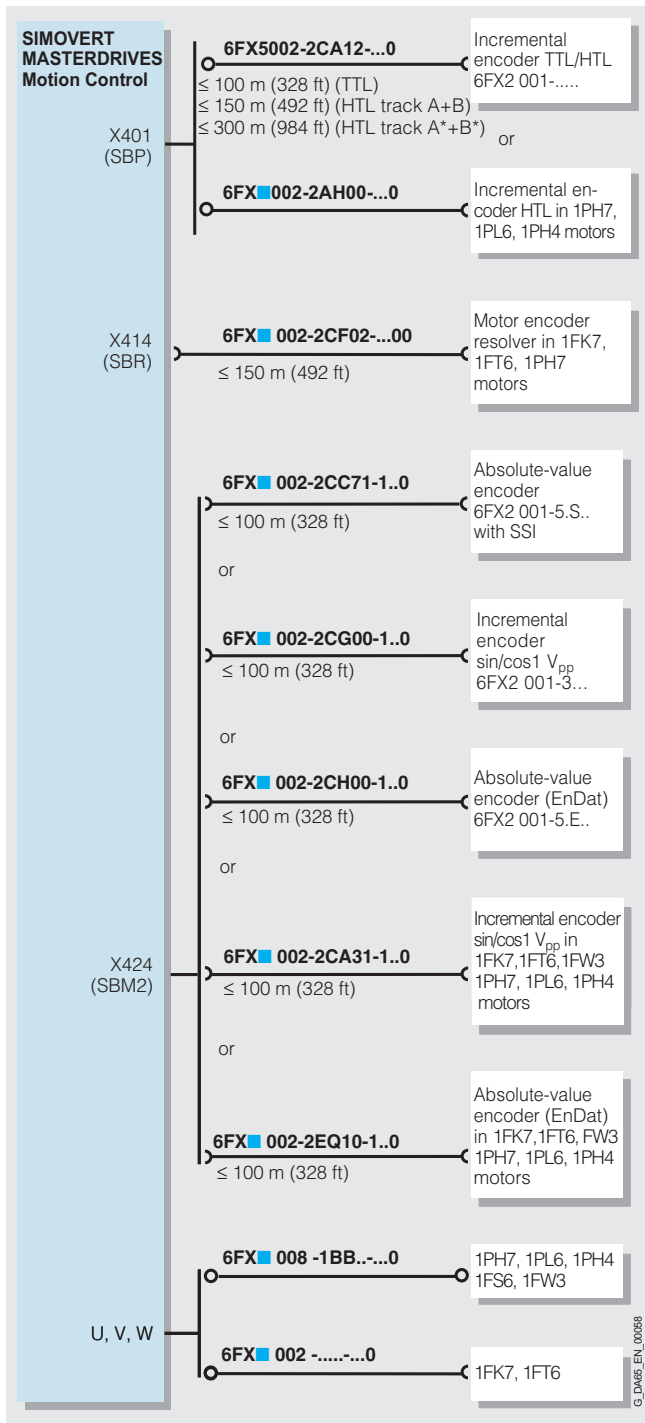

SIMOVERT MASTERDRIVES Motion Control Connection Overview

##### SIMOVERT MASTERDRIVES Vector Control

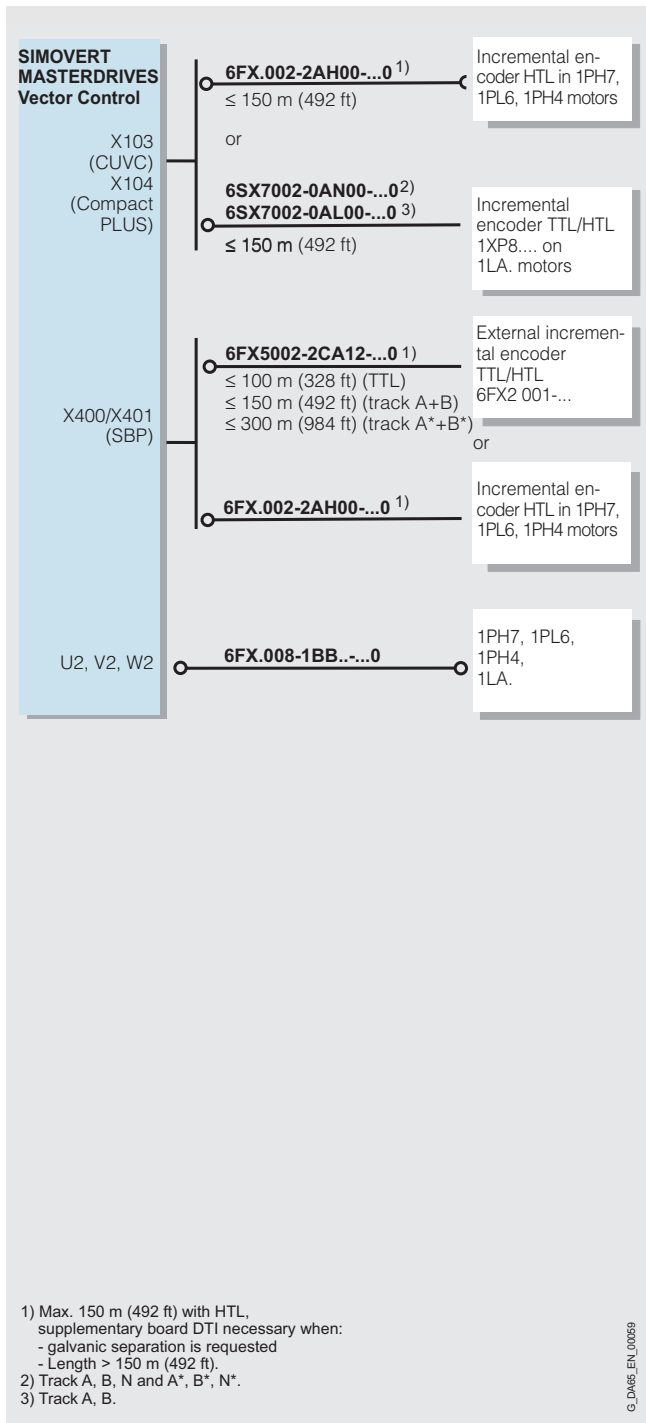

SIMOVERT MASTERDRIVES Vector Control Connection Overview

1) Max. 150 m (492 ft) with HTL, supplementary board DTI necessary when:  
 - galvanic separation is requested  
 - Length > 150 m (492 ft).  
 2) Track A, B, N and A\*, B\*, N\*.  
 3) Track A, B.

5

# Servo Motors for SIMOVERT MASTERDRIVES

## MOTION-CONNECT Cables and Connections

Signal Cables

For Connection to Motors with Incremental Encoder HTL (1,024 Pulses/Rev and 2,048 Pulses/Rev)<sup>1)</sup>

### Cable Configuration and Connector Assignment

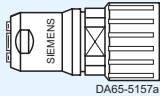
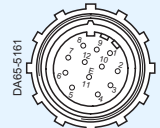
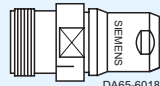
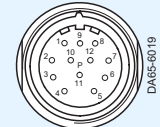
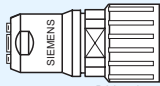
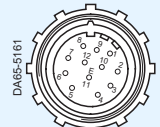
Base Cable Type 6FX . 002 – 2AH00 – . . . .			Cut-to-Length Cable 6FX . 008 – 1BD21			Measuring-System Side
Converter Side	Motion Control	Vector Control	Signal Name	Signal Name	PIN	
Cable End Cut	PIN	PIN	Signal Name	Signal Name	PIN	<b>Connector Type: 6FX2 003 – 0CE12</b>  
	71		* B	* B	1	
	63	30	KTY84 +	KTY84 +	2	
	72	26	ZEROTRACE	ZEROTRACE	3	
	73		* ZEROTRACE	* ZEROTRACE	4	
	68	24	A	A	5	
	69		* A	* A	6	
	74	27	CTRL TACHO	CTRL TACHO	7	
	70	25	B	B	8	
				Free	9	
	61	23	0 V	0 V	10	
	62	29	KTY84 –	KTY84 –	11	
	60	28	15 V	15 V	12	
External shield on connector housing					Yes	
<b>Cable Extension Type 6FX . 002 – 2AH04 – . . . 0</b>						
Connector Type: 6FX2 003 – 1CF12			PIN assignment of cable extension same as for base cable			Connector Type: 6FX2 003 – 0CE12
 						 

### Selection and Ordering Data

Cable	Order No.
<b>Cable Assemblies</b>	
Signal cables for connection to motors with incremental encoder HTL	
6FX ■ 002 – 2AH00 – ■ ■ ■ 0	
MOTION-CONNECT 800	8
MOTION-CONNECT 500	5
0 m (0 ft)	1
100 m (328 ft)	2
200 m (656 ft)	3
300 m (984 ft)	4
0 m (0 ft)	A
10 m (33 ft)	B
20 m (66 ft)	C
30 m (98 ft)	D
40 m (131 ft)	E
50 m (164 ft)	F
60 m (197 ft)	G
70 m (229 ft)	H
80 m (263 ft)	J
90 m (295 ft)	K
0 m (0 ft)	A
1 m (3.3 ft)	B
2 m (6.6 ft)	C
3 m (9.8 ft)	D
4 m (13.1 ft)	E
5 m (16.4 ft)	F
6 m (19.7 ft)	G
7 m (23 ft)	H
8 m (26.2 ft)	J
9 m (29.5 ft)	K
<b>Length Code</b>	

**Examples:** 1 m (3.3 ft): ... – 1 A B 0    59 m (193.5 ft): ... – 1 F K 0  
 8 m (26.2 ft): ... – 1 A J 0    111 m (364 ft): ... – 2 B B 0  
 17 m (56 ft): ... – 1 B H 0    262 m (860 ft): ... – 3 G C 0

Cable	Length m (ft)	Order No.
<b>Cut-to-Length Cable</b>		
Signal cables for connection to motors with incremental encoder HTL	50 (164)	6FX ■ 008 – 1BD21 – 1FA0
No. of cores x cross-section [mm <sup>2</sup> ] 4 x 2 x 0.34 + 4 x 0.5	100 (328)	6FX ■ 008 – 1BD21 – 2AA0
	200 (656)	6FX ■ 008 – 1BD21 – 3AA0
	500 (1640)	6FX ■ 008 – 1BD21 – 6AA0

External cable diameter for 6FX8: 9.3 mm (0.37 in) **8**  
 External cable diameter for 6FX5: 9.3 mm (0.37 in) **5**

<sup>1)</sup> Cable length ≤ 150 m (492 ft) without transmission of inverted signals and cable length between 150 m (492 ft) and 300 m (984 ft) with transmission of inverted signals and use of D module.

5





# Servo Motors for SIMOVERT MASTERDRIVES

## MOTION-CONNECT Cables and Connections

### Signal Cables

#### For Connection to Motors with 2-pole/Multipole Resolver

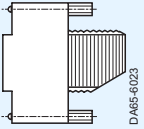
##### Cable Configuration and Connector Assignment

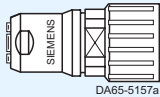
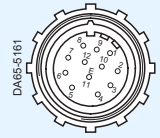
Base Cable Type 6FX . 002 – 2CF02 – . . . .	Cut-to-Length Cable 6FX . 008 – 1BD41				Measuring-System Side
Converter Side	PIN	Signal Name	Signal Name	PIN	
<b>Connector Type:</b> <b>6FC9 348 – 7HP00</b>  	3	SIN	SIN	1	<b>Connector Type:</b> <b>6FX2 003 – 0CE12</b>  
	4	* SIN	* SIN	2	
	5	Inner shield		3	
	6	COS	COS	11	
	7	* COS	* COS	12	
	8	Inner shield		5	
	13	+TEMP	+TEMP	8	
	25	–TEMP	–TEMP	9	
	24	Inner shield		4	
	9	+V <sub>pp</sub>	+V <sub>pp</sub>	10	
	11	–V <sub>pp</sub>	–V <sub>pp</sub>	7	
	Yes	Overall shield on connector housing		Yes	

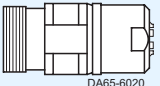
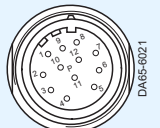
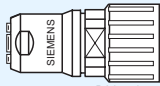
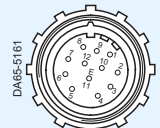
Cable Extension Type 6FX . 002 – 2CF04 – . . . .	PIN assignment of cable extension same as for base cable		Connector Type: 6FX2 003 – 0CE12
<b>Connector Type:</b> <b>6FX2 003 – 1CF12</b>  			 

##### Selection and Ordering Data

Cable	Order No.
<b>Cable Assemblies (Length &lt; 150 m (492 ft))</b>	
Signal cables for connection to motors equipped with a resolver (for measurement of rotor position and speed generation)	
Preassembled	<b>6FX ■ 002 – 2CF02 – ■ ■ ■ 0</b>
MOTION-CONNECT 800	<b>8</b>
MOTION-CONNECT 500	<b>5</b>
0 m (0 ft)	<b>1</b>
100 m (328 ft)	<b>2</b>
0 m (0 ft)	<b>A</b>
10 m (33 ft)	<b>B</b>
20 m (66 ft)	<b>C</b>
30 m (98 ft)	<b>D</b>
40 m (131 ft)	<b>E</b>
50 m (164 ft)	<b>F</b>
60 m (197 ft)	<b>G</b>
70 m (229 ft)	<b>H</b>
80 m (263 ft)	<b>J</b>
90 m (295 ft)	<b>K</b>

##### Length Code

**Examples:** 1 m (3.3 ft): . . . – 1 A B 0    59 m (193.5 ft): . . . – 1 F K 0  
 8 m (26.2 ft): . . . – 1 A J 0    111 m (364 ft): . . . – 2 B B 0  
 17 m (56 ft): . . . – 1 B H 0

Cable	Length m (ft)	Order No.
<b>Cut-to-Length Cables <sup>1)</sup></b>		
Signal cables for connection to motors equipped with a resolver (for measurement of rotor position and speed generation)		
No. of cores x cross-section [mm <sup>2</sup> ]		
3 x 2 x 0.14 + 4 x 0.14 + 2 x 0.5	50 (164)	<b>6FX ■ 008 – 1BD41 – 1FA0</b>
	100 (328)	<b>6FX ■ 008 – 1BD41 – 2AA0</b>
	200 (656)	<b>6FX ■ 008 – 1BD41 – 3AA0</b>
	500 (1640)	<b>6FX ■ 008 – 1BD41 – 6AA0</b>

External cable diameter for 6FX8:	<b>8</b>
External cable diameter for 6FX5:	<b>5</b>

1) Maximum permissible length of preassembled cables for the resolvers: 150 m (492 ft).

# Servo Motors for SIMOVERT MASTERDRIVES



## MOTION-CONNECT Cables and Connections

### Signal Cables

For Connection to Motors with Incremental Encoder sin/cos 1 V<sub>pp</sub>

#### Cable Configuration and Connector Assignment

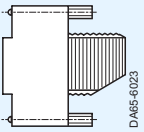
##### Base Cable Type 6FX . 002 – 2CA31 – . . . .

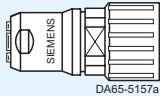
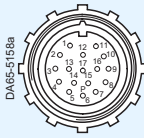
Converter Side	Cut-to-Length Cable 6FX . 008 – 1BD51				Measuring-System Side	
Connector Type: 6FC9 348 – 7HP00	PIN	Signal Name	Signal Name	PIN	Connector Type: 6FX2 003 – 0CE17	
  6FX . 002-2CA31- . . . . Cable outlet on bottom  6FX . 002-2YS01- . . . . Cable outlet on top	3	A	Ua1	1	 	
	4	* A	* Ua1	2		
	5		Inner shield	17		
	6	B	Ua2	11		
	7	* B	* Ua2	12		
	8		Inner shield	17		
	17	R	Ua0	3		
	18	* R	* Ua0	13		
	24		Inner shield	17		
	19	C	Ua3	5		
	20	* C	* Ua3	6		
	21	D	Ua4	14		
	22	* D	* Ua4	4		
	13	+Temp	+Temp	8		
	25	-Temp	-Temp	9		
	1	P encoder	P encoder	10		
	14	5 V Sense	5 V Sense	16		
	2	M encoder	M encoder	7		
	16	0 V Sense	0 V Sense	15		
	Yes	Overall shield on connector housing				Yes

##### Cable Extension Type 6FX . 002 – 2CA34 – . . . .

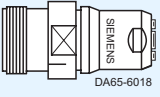
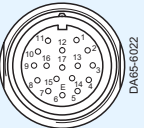
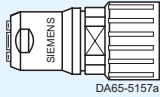
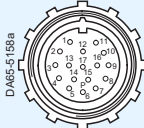
Connector Type: 6FX2 003 – 1CF17	PIN assignment of cable extension same as for base cable	Connector Type: 6FX2 003 – 0CE17
 		 

#### Selection and Ordering Data

Cable	Order No.
<b>Cable Assemblies (Length &lt; 100 m (328 ft))</b>	
Signal Cables for connection to motors equipped with an incremental encoder sin/cos 1 V <sub>pp</sub> (for measuring rotor position and speed generation)	
Preassembled	<b>6FX ■ 002 – 2CA31 – ■ ■ ■ 0</b>
MOTION-CONNECT 800	<b>8</b>
MOTION-CONNECT 500	<b>5</b>
0 m (0 ft)	<b>1</b>
100 m (328 ft)	<b>2</b>
0 m (0 ft)	<b>A</b>
10 m (33 ft)	<b>B</b>
20 m (66 ft)	<b>C</b>
30 m (98 ft)	<b>D</b>
40 m (131 ft)	<b>E</b>
50 m (164 ft)	<b>F</b>
60 m (197 ft)	<b>G</b>
70 m (229 ft)	<b>H</b>
80 m (263 ft)	<b>J</b>
90 m (295 ft)	<b>K</b>

#### Length Code

Examples: 1 m (3.3 ft): . . . – 1 A B 0    17 m (56 ft): . . . – 1 B H 0  
 8 m (26.2 ft): . . . – 1 A J 0    59 m (193.5 ft): . . . – 1 F K 0

Cable	Length m (ft)	Order No.
<b>Cut-to-Length Cables <sup>1)</sup></b>		
Signal Cables for connection to motors equipped with an incremental encoder sin/cos 1 V <sub>pp</sub> (for measuring rotor position and speed generation)		
No. of cores x cross-section [mm <sup>2</sup> ]		
3 x 2 x 0.14 + 4 x 0.14 + 2 x 0.5 + 4 x 0.23	50 (164)	<b>6FX ■ 008 – 1BD51 – 1FA0</b>
	100 (328)	<b>6FX ■ 008 – 1BD51 – 2AA0</b>
	200 (656)	<b>6FX ■ 008 – 1BD51 – 3AA0</b>
	500 (1640)	<b>6FX ■ 008 – 1BD51 – 6AA0</b>

External cable diameter for 6FX8:	<b>8</b>
9.9 mm (0.39 in)	
External cable diameter for 6FX5:	<b>5</b>
9.9 mm (0.39 in)	

1) Maximum permissible length of preassembled cables for incremental encoder sin/cos 1 V<sub>pp</sub>: 100 m (328 ft).



# Servo Motors for SIMOVERT MASTERDRIVES

## MOTION-CONNECT Cables and Connections

### Signal Cables

#### For Connection to Motors with Absolute Encoder (EnDat)

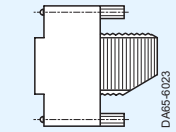
##### Cable Configuration and Connector Assignment

Base Cable Type 6FX . 002 – 2EQ10 – . . . .		Cut-to-Length Cable 6FX . 008 – 1BD51	Measuring-System Side	
Converter Side	PIN	Signal Name	PIN	
<b>Connector Type:</b> 6FC9 348 – 7HP00   	3	A	Ua1	1
	4	* A	* Ua1	2
	5		Inner shield	17
	6	B	Ua2	11
	7	* B	* Ua2	12
	8		Inner shield	17
	15	Data	Data	3
	23	* Data	* Data	13
	24		Inner shield	17
	10	Clock cycle	Clock cycle	5
	12	* Clock cycle	* Clock cycle	14
	13	+ Temp	+ Temp	8
	25	– Temp	– Temp	9
	1	P encoder	P encoder	10
	14	5 V Sense	5 V Sense	16
	2	M encoder	M encoder	7
16	0 V Sense	0 V Sense	15	
Yes		Overall shield on connector housing	Yes	

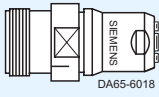
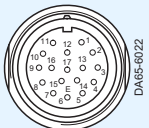
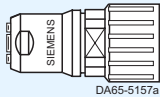
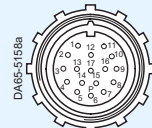
Cable Extension Type 6FX . 002 – 2EQ14 – . . . .		PIN assignment of cable extension same as for base cable	Measuring-System Side
<b>Connector Type:</b> 6FX2 003 – 1CF17   			<b>Connector Type:</b> 6FX2 003 – 0CE17   

##### Selection and Ordering Data

Cable	Order No.
<b>Cable Assemblies (Length &lt; 100 m (328 ft))</b>	
Signal cables for connection to motors equipped with an incremental encoder sin/cos 1 V <sub>pp</sub> (for measuring rotor position and speed generation)	
Preassembled	<b>6FX ■ 002 – 2EQ10 – ■ ■ ■ 0</b>
MOTION-CONNECT 800	<b>8</b>
MOTION-CONNECT 500	<b>5</b>
0 m (0 ft)	<b>1</b>
100 m (328 ft)	<b>2</b>
0 m (0 ft)	<b>A</b>
10 m (33 ft)	<b>B</b>
20 m (66 ft)	<b>C</b>
30 m (98 ft)	<b>D</b>
40 m (131 ft)	<b>E</b>
50 m (164 ft)	<b>F</b>
60 m (197 ft)	<b>G</b>
70 m (229 ft)	<b>H</b>
80 m (263 ft)	<b>J</b>
90 m (295 ft)	<b>K</b>

##### Length Code

**Examples:** 1 m (3.3 ft): . . . – 1 A B 0    17 m (56 ft): . . . – 1 B H 0  
 8 m (26.2 ft): . . . – 1 A J 0    59 m (193.5 ft): . . . – 1 F K 0

Cable	Length m (ft)	Order No.
<b>Cut-to-Length Cables <sup>1)</sup></b>		
Signal cables for connection to motors equipped with an absolute encoder (for measurement of absolute position and speed generation)		
	50 (164)	<b>6FX ■ 008 – 1BD51 – 1FA0</b>
No. of cores x cross-section [mm <sup>2</sup> ]	100 (328)	<b>6FX ■ 008 – 1BD51 – 2AA0</b>
3 x 2 x 0.14 + 4 x 0.14 + 2 x 0.5 + 4 x 0.23	200 (656)	<b>6FX ■ 008 – 1BD51 – 3AA0</b>
	500 (1640)	<b>6FX ■ 008 – 1BD51 – 6AA0</b>

External cable diameter for 6FX8: 9.9 mm (0.39 in) **8**

External cable diameter for 6FX5: 9.9 mm (0.39 in) **5**

1) Maximum permissible length of preassembled cables for the absolute encoders: 100 m (328 ft).

# Servo Motors for SIMOVERT MASTERDRIVES

## MOTION-CONNECT Cables and Connections

Length Code

### Selection and Ordering Data

Designation	Order No.
<b>Cable Assemblies</b>	<b>6FX1 002 - ..... - ■■■ 0</b>
	<b>6FX5 002 - ..... - ■■■ 0</b>
	<b>6FX5 102 - ..... - ■■■ 0</b>
	<b>6FX7 002 - ..... - ■■■ 0</b>
	<b>6FX8 002 - ..... - ■■■ 0</b>

Length Code:	
0 m (0 ft)	1
100 m (328.2 ft)	2
200 m (656.3 ft)	3
300 m (984.4 ft)	4

0 m (0 ft)	A
10 m (32.8 ft)	B
20 m (65.6 ft)	C
30 m (98.4 ft)	D
40 m (131.3 ft)	E
50 m (164.1 ft)	F
60 m (196.9 ft)	G
70 m (229.7 ft)	H
80 m (262.5 ft)	J
90 m (295.3 ft)	K

0 m (0 ft)	A
1 m (3.3 ft)	B
2 m (6.6 ft)	C
3 m (9.8 ft)	D
4 m (13.1 ft)	E
5 m (16.4 ft)	F
6 m (19.7 ft)	G
7 m (23 ft)	H
8 m (26.3 ft)	J
9 m (29.5 ft)	K

Examples:		
1.0 m (3.3 ft):	1	A B
2.0 m (6.6 ft):	1	A C
8.0 m (26.3 ft):	1	A J
299.0 m (981.2 ft):	3	K K

### Selection and Ordering Data

Designation	Order No.
<b>Power Cables/Signal Cables, Cut to Length<sup>1)</sup></b>	
• 50 m (164.1 ft)	<b>6FX. 008 - ..... - 1FA0</b>
• 100 m (328.2 ft)	<b>6FX. 008 - ..... - 2AA0</b>
• 300 m (984.4 ft)	<b>6FX. 008 - ..... - 3AA0</b>
• 500 m (1640.8 ft)	<b>6FX. 008 - ..... - 6AA0</b>

### Additional Information

#### Fixed Length for Signal Cables 6FX . 002 - ..... - 1...

Order No.	Length in m (ft)							
	1 (3.3)	1.5 (4.9)	2 (6.6)	3 (9.8)	5 (16.4)	7 (23)	10 (32.8)	
<b>6FX2 002-1CA01-1 ■■■ 0</b>	AB		AC		AF		AH	
<b>6FX2 002-1CB01-1 ■■■ 0</b>	AB		AC		AF		AH	
<b>6FX2 002-1CC00-1 ■■■ ■</b>		AB5	AC0		AF0			
<b>6FX2 002-4EA04-1 ■■■ 0</b>					AF		BA	
<b>6FX5 002-1AA00-1 ■■■ 0</b>				AD	AF		BA	
<b>6FX8 002-2CA41-1 ■■■ 0</b>					AF		BA	

#### Length Definition for Cable Assemblies

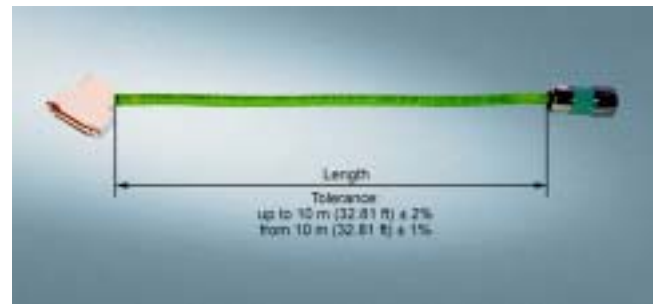

5

1) Power cables 4 mm<sup>2</sup> and larger can be ordered by the exact meter up to 100 m (328 ft). Power cables of 1.5 mm<sup>2</sup> and 2.5 mm<sup>2</sup> are supplied in rings or single-use drums of 50 m (164 ft), 100 m (328 ft), 200 m (656 ft), and 500 m (1,641 ft).

# Servo Motors for SIMOVERT MASTERDRIVES

## MOTION-CONNECT Cables and Connections

Notes

5



6/2	<b>Operating Instructions</b>
6/2	<b>Planning Guides</b>



# Servo Motors for SIMOVERT MASTERDRIVES

## Documentation

### Operating Instructions Planning Guides

#### Operating Instructions

Motor Type	Language	Order No.	Edition
1FK603 . to 1FK610 .	German/English French/Spanish Italian/Swedish	<b>610.43430.21</b>	April 2002
1FK702 . to 1FK710 .	German/English French/Spanish Italian/Swedish	<b>610.40700.21</b>	April 2002
1FT602 . to 1FT610 .	German/English French/Spanish Italian/Swedish	<b>610.43410.21</b>	July 2003
1FT613 . to 1FT616 .	German/English French/Spanish Italian/Swedish	<b>610.43600.21</b>	July 2003
1FS607 . to 1FS613 .	German/English	<b>610.40068.01</b>	January 2002
1FK7 Servo Gearbox Motors	German/English French/Spanish Italian/Swedish	<b>610.40064.01</b>	December 2003
1FW320 . to 1FW328 .	German	<b>610.40.300.02</b>	April 2004
1PH710 . to 1PH716 .	German/English French/Spanish Italian/Swedish	<b>610.43429.21</b>	1997
1PH718 .	German	<b>A5E00215737A</b>	2003/2004
	English	<b>A5E00215729A</b>	
	Spanish	<b>A5E00215745A</b>	
	French	<b>A5E00215713A</b>	
	Italian	<b>A5E00215741A</b>	
1PH722 .	German	<b>A5E00264361A</b>	2004
	English	<b>A5E00264369A</b>	
	Spanish	<b>A5E00264372A</b>	
	French	<b>A5E00264534A</b>	
	Italian	<b>A5E00264543A</b>	
1PH728 .	German	<b>A5E00171047A</b>	2002
	English	<b>A5E00177602A</b>	
	Spanish	<b>A5E00205680A</b>	
	French	<b>A5E00205665A</b>	
	Italian	<b>A5E00205677A</b>	
	Swedish	<b>A5E00205684A</b>	

#### Operating Instructions (continued)

Motor Type	Language	Order No.	Edition	
1PL618 .	German	<b>A5E00215739A</b>	2003/2004	
	English	<b>A5E00215731A</b>		
	Spanish	<b>A5E00215746A</b>		
	French	<b>A5E00215726A</b>		
	Italian	<b>A5E00215743A</b>		
1PL622 .	German	<b>A5E00264364A</b>	2004	
	English	<b>A5E00264365A</b>		
	Spanish	<b>A5E00264370A</b>		
	French	<b>A5E00264374A</b>		
	Italian	<b>A5E00264537A</b>		
1PL628 .	German	<b>A5E00264546A</b>	2002	
	English	<b>A5E00171048A</b>		
	Spanish	<b>A5E00177606A</b>		
	French	<b>A5E00205688A</b>		
	Italian	<b>A5E00205687A</b>		
	Swedish	<b>A5E00205693A</b>		
	1PH410 . to 1PH416 .	German/English	<b>610.43.424.21a</b>	May 1998

#### Planning Guides

Motor Type	Model	Language	Order No.
Synchronous Servo Motors	SIMODRIVE 611, MASTERDRIVES MC General Part	English	<b>6SN1197 – 0AD07 – 0BP1</b>
1FK7	SIMODRIVE 611, MASTERDRIVES MC Motor Part	English	<b>6SN1197 – 0AD06 – 0BP0</b>
1FT6	SIMODRIVE 611, MASTERDRIVES MC Motor Part	English	<b>6SN1197 – 0AD02 – 0BP0</b>
1FS6	MASTERDRIVES MC	English	<b>6SN1197 – 0AD08 – 0BP0</b>
1FW3	MASTERDRIVES MC	English	<b>6SN1197 – 0AC70 – 0BP0</b>
1PH7, 1PL6, 1PH4	SIMODRIVE, MASTER- DRIVES VC/MC General Part	English	<b>6SN1197 – 0AC62 – 0BP0</b>
1PH7	MASTERDRIVES VC/MC Motor Part	English	<b>6SN1197 – 0AC66 – 0BP0</b>
1PL6	MASTERDRIVES VC/MC Motor Part	English	<b>6SN1197 – 0AC67 – 0BP0</b>
1PH4	Motor Part	English	<b>6SN1197 – 0AC64 – 0BP0</b>

#### Further Information

For more information, visit  
<http://www.siemens.com/motioncontrol>  
 → Support → Technical documentation  
 → Overview of publications.



## Additional Data for Motors 1PH7 and 1PL6

- 7/2 Ventilation Data and Sound Pressure Level
- 7/3 Bearing Design/Drive Type and Maximum Rotational Speeds
- 7/4 Cantilever Force Diagrams
- 7/6 Terminal Box Assignment  
Maximum Connectable Cable Cross-Sections
- 7/8 Types of construction

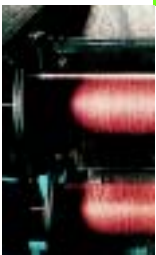



# Servo Motors for SIMOVERT MASTERDRIVES

## Engineering Information

### Additional Data for Motors 1PH7 and 1PL6

#### Ventilation Data and Sound Pressure Level

Shaft Height	Fan Motor: Power Consumption at			Direction of Air Flow	Sound Pressure Level $L_{pA}$ Motor + Separately Driven Fan Rated Load, 50 Hz Tolerance + 3 dB	Air Flow Rate at 50 Hz Approx.
	400 V/50 Hz (±10 %)	400 V/60 Hz (±10 %)	480 V/60 Hz (+5 %, -10 %)			
	A	A	A		1 dB (A)	m <sup>3</sup> /s (ft <sup>3</sup> /s)
<b>1PH7 Motors</b>						
100	0.19	0.13	0.18	NDE → DE	70	0.04 (1.41)
	0.20	0.13	0.20	DE → NDE	70	0.04 (1.41)
132	0.35	0.24	0.32	NDE → DE	70	0.1 (3.53)
	0.37	0.24	0.33	DE → NDE	70	0.1 (3.53)
160	0.29	0.31	0.33	NDE → DE	72	0.15 (5.3)
	0.30	0.33	0.34	DE → NDE	75	0.15 (5.3)
180	0.8	1.1	1.1	NDE → DE, DE → NDE	73	0.19 (6.71)
	1.9	2.2	2.2	NDE → DE	74	0.36 (12.71)
225	2.8	2.8	2.8	DE → NDE	76	0.36 (12.71)
	2.55	2.6	2.6	NDE → DE, DE → NDE	74	0.42 (14.83)
<b>1PL6 Motors</b>						
180	0.8	1.1	1.1	NDE → DE, DE → NDE	73 <sup>1)</sup>	0.27 (9.54)
225	1.9	2.2	2.2	NDE → DE	74 <sup>1)</sup>	0.38 (13.42)
	2.8	2.8	2.8	DE → NDE	76 <sup>1)</sup>	0.38 (13.42)
280	2.55	2.6	2.6	NDE → DE, DE → NDE	74 <sup>1)</sup>	0.52 (18.36)

1) Speed range 0 to 2,000 rpm.

#### Bearing Design/Drive Type and Maximum Rotational Speeds

Shaft Height/ Motor Type	Bearing Type/ Drive Type	Bearing Type	Motor Side Bearing ID	Max Continuous Speed in S1 Duty		Max. Limit Speed <sup>1)</sup>	
				$n_{S1}$ rpm	$n_{S1}^{2)}$ rpm	$n_{max.}$ rpm	$n_{max.}^{2)}$ rpm
100	Deep-groove ball bearing for coupling or belt drive	DE	6308 C4	5500	10000	9000	12000
		NDE	6208 C4				
132	Deep-groove ball bearing for coupling or belt drive	DE	6310 C4	4500	8500	8000	10000
		NDE	6210 C4				
160	Deep-groove ball bearing for coupling or belt drive	DE	6312 C4	3700	7000	6500	8000
		NDE	6212 C4				
180	Deep-groove ball bearing for coupling drive	DE	6214 C3	3500	4500	5000	7000
		NDE	6214 C3				
	Cylindrical roller bearing for belt drive	DE	NU22 14E				
		NDE	6214 C3		–	5000	–
	Cylindrical-roller bearing for strong cantilever forces	DE	NU22 14E	3000	–	5000	–
		NDE	6214 C3				
225	Deep-groove ball bearing for coupling drive	DE	6216 C3	3100	3600 (for 1PH7224)	4500	5500 (for 1PH7224)
		NDE	6216 C3				
	Cylindrical roller bearing for belt drive	DE	NU22 16E	3100	–	4500	–
		NDE	6216 C3				
Type 224, 226	Cylindrical-roller bearing for strong cantilever forces	DE	NU22 16E	2700	–	4500	–
		NDE	6216 C3				
Type 228	Cylindrical-roller bearing for strong cantilever forces	DE	NU22 16E	2500	–	4000	–
		NDE	6216 C3				
280	Deep-groove ball bearing for coupling drive	DE	6220 C3	2200	–	3300	–
		NDE	6220 C3				
	Cylindrical roller bearing for belt drive	DE	NU22 0E	2200	–	3300	–
		NDE	6220 C3				

#### Statistical Bearing Lifetime $L_{10h}$ (Nominal Rated Lifetime)

The statistical bearing lifetime is defined according to standardized calculation procedures (DIN ISO 281) and, for 90% of the bearings, is reached or even exceeded when the motors are operated in compliance with the data provided in this catalog.

The bearing lifetime is determined primarily by the bearing size and load, the operating conditions, the speed, and the lubrication interval.

The values specified in the cantilever force diagrams are applicable at a coolant temperature of up to 40 °C (104 °F) maximum, a horizontal mounting position, and an average operating speed  $\leq 2,000$  rpm. For additional information, refer to the planning guides.

#### Permanent Lubrication

With permanent lubrication, the bearing grease lifetime is the same as the bearing lifetime. For permanent lubrication, the motor must be operated in accordance with catalog specifications.

The basic version of motors up to and including shaft height 225 have permanent lubrication.

#### Relubrication

For motors that can be relubricated at defined intervals, the bearing lifetime can be extended and/or unfavorable factors such as temperature, mounting conditions, speed, bearing size, and mechanical load can be compensated.

Relubrication with a lubricating nipple is a standard feature for motors with a shaft height of 280.

For motors with shaft heights of 180 to 225, relubrication with a lubricating nipple is optional, Order Code K40.

1) During continuous duty (with 30%  $n_{max.}$ , 60%  $\frac{2}{3} n_{max.}$ , 10% standstill) for a cycle duration of 10 min.

2) See Ordering Options, Part 3 (1PH7 only) for a model with higher maximum speed.

# Servo Motors for SIMOVERT MASTERDRIVES

## Engineering Information

### Additional Data for Motors 1PH7 and 1PL6

#### Cantilever Force Diagrams

##### Permissible Cantilever Forces 1PH7 Motors Shaft Height 100

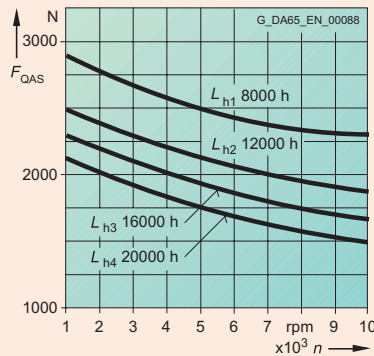
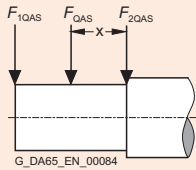

$x = 40 \text{ mm (1.57 in)}$   
 $F_{1QAS} = 0.9 F_{QAS}$   
 $F_{2QAS} = 1.1 F_{QAS}$   
 $L_{h1}, L_{h2}, L_{h3}, L_{h4} =$  Estimated lifetime for varying operating conditions ( $F_{QAS}; n$ )  
 $q =$  residual effect [%] at constant conditions

$$L_{10\text{tot}} = \frac{100}{\frac{q_1}{L_{h1}} + \frac{q_2}{L_{h2}} + \frac{q_3}{L_{h3}} + \frac{q_4}{L_{h4}}}$$

##### Permissible Cantilever Forces 1PH7 Motors Shaft Height 132

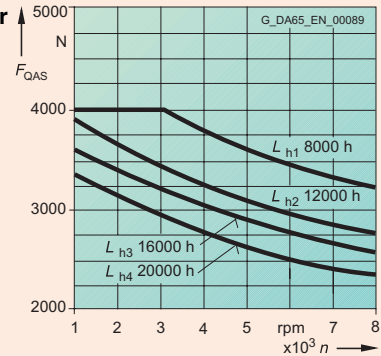
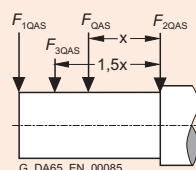

$x = 55 \text{ mm (2.17 in)}$   
 $F_{1QAS} = \text{max. } 2,000 \text{ N (450 lb}_f\text{)}$   
 $F_{2QAS} = 1.1 F_{QAS}$   
 $F_{3QAS} = \text{max. } 2,500 \text{ N (560 lb}_f\text{)}$   
 $L_{h1}, L_{h2}, L_{h3}, L_{h4} =$  Estimated lifetime for varying operating conditions ( $F_{QAS}; n$ )  
 $q =$  residual effect [%] at constant conditions

$$L_{10\text{tot}} = \frac{100}{\frac{q_1}{L_{h1}} + \frac{q_2}{L_{h2}} + \frac{q_3}{L_{h3}} + \frac{q_4}{L_{h4}}}$$

##### Permissible Cantilever Forces 1PH7 Motors Shaft Height 160

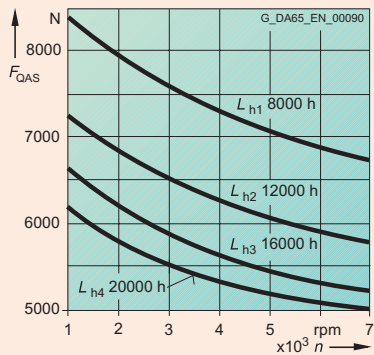
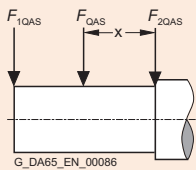

$x = 55 \text{ mm (2.17 in)}$   
 $F_{1QAS} = 0.9 F_{QAS}$   
 $F_{2QAS} = 1.1 F_{QAS}$   
 $L_{h1}, L_{h2}, L_{h3}, L_{h4} =$  Estimated lifetime for varying operating conditions ( $F_{QAS}; n$ )  
 $q =$  residual effect [%] at constant conditions

$$L_{10\text{tot}} = \frac{100}{\frac{q_1}{L_{h1}} + \frac{q_2}{L_{h2}} + \frac{q_3}{L_{h3}} + \frac{q_4}{L_{h4}}}$$

##### Permissible Cantilever Forces Motors 1PH718. and 1PL618. Shaft Height 180 for Coupling Drive

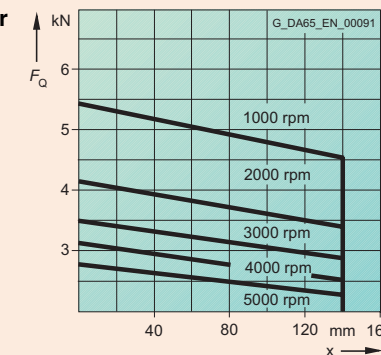
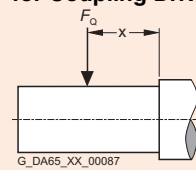

$L_{10h} = 20,000 \text{ h}$

##### Permissible Cantilever Forces Motors 1PH722. and 1PL622. Shaft Height 225 for Coupling Drive

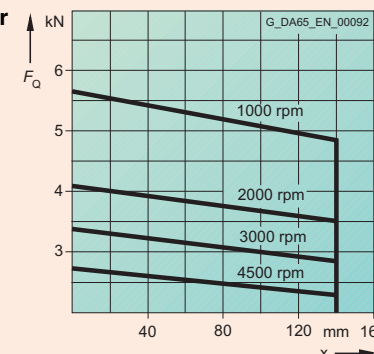
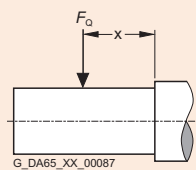

$L_{10h} = 20,000 \text{ h}$

##### Permissible Cantilever Forces Motors 1PH718. and 1PL618. Shaft Height 180 for Belt Drive

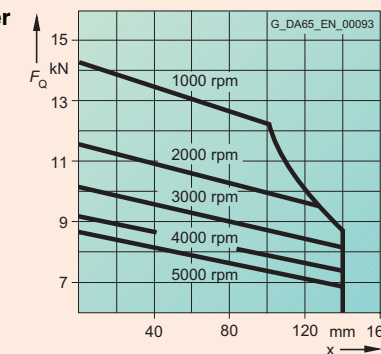
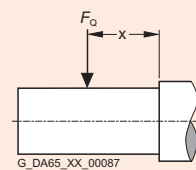

Minimum cantilever force  
3 kN (675 lb<sub>f</sub>)

$L_{10h} = 12,000 \text{ h}$

No-load operation of the roller bearings used here can damage the bearings.  
Note the specified minimum cantilever forces!

#### Cantilever Force Diagrams

**Permissible Cantilever Forces Motors 1PH722. and 1PL622. Shaft Height 225 for Belt Drive**

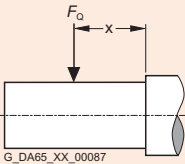

Minimum cantilever force 4 kN (900 lb<sub>f</sub>)

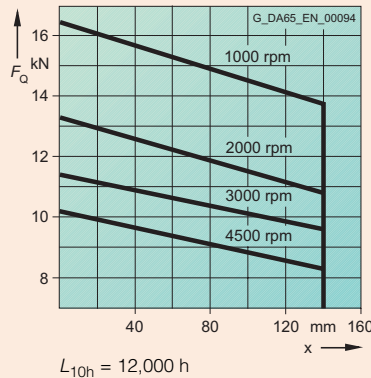

**Permissible Cantilever Forces Motors 1PH718. and 1PL618. Shaft Height 180 for Belt Drive with Increased Cantilever Force**

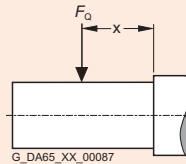

Minimum cantilever force 4 kN (900 lb<sub>f</sub>)

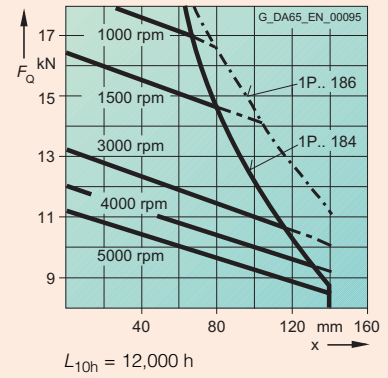

**Permissible Cantilever Forces Motors 1PH722. and 1PL622. Shaft Height 225 for Belt Drive with Increased Cantilever Force**

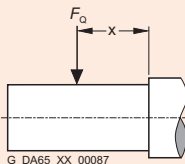

Minimum cantilever force 5 kN (1125 lb<sub>f</sub>)

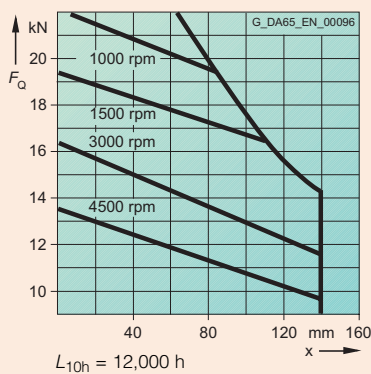

**Permissible Cantilever Forces Motors 1PH728. and 1PL628. Shaft Height 280 for Coupling Drive**

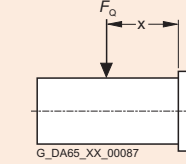

L<sub>10h</sub> > 20,000 h with relubrication

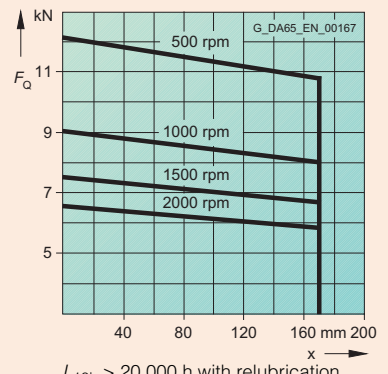

**Permissible Cantilever Forces Motors 1PH728. and 1PL628. Shaft Height 280 for Belt Drive with Increased Cantilever Force**

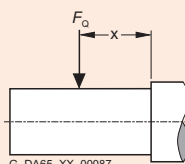

Minimum cantilever force 9 kN (2025 lb<sub>f</sub>)

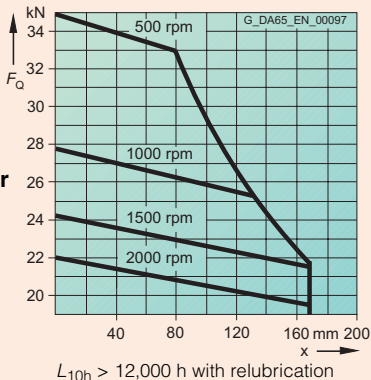

No-load operation of the roller bearings used here can damage the bearings. Note the specified minimum cantilever forces!

# Servo Motors for SIMOVERT MASTERDRIVES

## Engineering Information

### Additional Data for Motors 1PH7 and 1PL6

#### Terminal Box Assignment, Maximum Connectable Cable Cross-Sections

Shaft Height	Motor Type	Terminal Box Type	Cable Entry	Max. Poss. Cable Outer Diameter	Cable Entry	Max. Poss. Cable Outer Diameter	No. Main Terminals	Max. Conn. Cross-Section per Terminal	Max. Poss. Current per Terminal <sup>1)</sup>
				Valid for Position 8 of Order No.: "2", "4" or "6" <sup>3)</sup>	Valid for Position 8 of Order No.: "7" or "8"	mm (in)			
<b>1PH7 Motors</b>									
100	1PH710... ..	Integrated	PG 29	28 (1.1)	M 32 x 1.5	21 (0.83)	6 x M 5	25	84
132	1PH713... ..	Integrated	PG 36	34 (1.34)	M 40 x 1.5	28 (1.1)	6 x M 6	35	104
160	1PH716... ..	Integrated	PG 42	40 (1.57)	M 50 x 1.5	38 (1.5)	6 x M 6	50	123
180	1PH7184... ..	1XB7322	2 x PG 42	40 (1.57)	2 x M 50 x 1.5	38 (1.5)	3 x M 12	2 x 50	191
	1PH7186... .. B	1XB7322	2 x PG 42	40 (1.57)	2 x M 50 x 1.5	38 (1.5)	3 x M 12	2 x 50	191
	1PH7186... .. D	1XB7322	2 x PG 42	40 (1.57)	2 x M 50 x 1.5	38 (1.5)	3 x M 12	2 x 50	191
	1PH7186... .. F	1XB7422	2 x M 72 x 2	56 (2.2)	2 x M 63 x 1.5	53 (2.09)	3 x M 12	2 x 70	242
	1PH7186... .. L	1XB7422	2 x M 72 x 2	56 (2.2)	2 x M 63 x 1.5	53 (2.09)	3 x M 12	2 x 70	242
225	1PH7224... .. B	1XB7322	2 x PG 42	40 (1.57)	2 x M 50 x 1.5	38 (1.5)	3 x M 12	2 x 50	191
	1PH7224... .. D	1XB7322	2 x PG 42	40 (1.57)	2 x M 50 x 1.5	38 (1.5)	3 x M 12	2 x 50	191
	1PH7224... .. U	1XB7422	2 x M 72 x 2	56 (2.2)	2 x M 63 x 1.5	53 (2.09)	3 x M 12	2 x 70	242
	1PH7224... .. L	1XB7700	3 x M 72 x 2	56 (2.2)	3 x M 75 x 1.5	68 (2.68)	3 x 2 x M 12	3 x 150	583
	1PH7226... .. B	1XB7322	2 x PG 42	40 (1.57)	2 x M 50 x 1.5	38 (1.5)	3 x M 12	2 x 50	191
	1PH7226... .. D	1XB7422	2 x M 72 x 2	56 (2.2)	2 x M 63 x 1.5	53 (2.09)	3 x M 12	2 x 70	242
	1PH7226... .. F	1XB7700	3 x M 72 x 2	56 (2.2)	3 x M 75 x 1.5	68 (2.68)	3 x 2 x M 12	3 x 150	583
	1PH7226... .. L	1XB7700	3 x M 72 x 2	56 (2.2)	3 x M 75 x 1.5	68 (2.68)	3 x 2 x M 12	3 x 150	583
	1PH7228... .. B	1XB7322	2 x PG 42	40 (1.57)	2 x M 50 x 1.5	38 (1.5)	3 x M 12	2 x 50	191
	1PH7228... .. D	1XB7700	3 x M 72 x 2	56 (2.2)	3 x M 75 x 1.5	68 (2.68)	3 x 2 x M 12	3 x 150	583
	1PH7228... .. F	1XB7700	3 x M 72 x 2	56 (2.2)	3 x M 75 x 1.5	68 (2.68)	3 x 2 x M 12	3 x 150	583
	1PH7228... .. L	1XB7700	3 x M 72 x 2	56 (2.2)	3 x M 75 x 1.5	68 (2.68)	3 x 2 x M 12	3 x 150	583
	280	1PH728... .. B	1XB7712	3 x M 63 x 1.5	53 (2.09)	–	–	(3+1) <sup>4</sup> x 3 x M 16	3 x 95
1PH7284... .. D									
1PH7286... .. D		1XB7712	3 x M 75 x 1.5	68 (2.68)	–	–	(3+1) <sup>4</sup> x 3 x M 16	3 x 185	710
1PH7288... .. D									
1PH728... .. F									

1) Current-carrying capacity based on IEC 60204-1, Routing Type C.  
2) Depends on type of metric cable gland.

3) Not for shaft height 280.  
4) Including ground terminal.

# Servo Motors for SIMOVERT MASTERDRIVES

## Engineering Information

### Additional Data for Motors 1PH7 and 1PL6

#### Terminal Box Assignment, Maximum Connectable Cable Cross-Sections

Shaft Height	Motor Type	Terminal Box Type	Cable Entry	Max. Poss. Cable Outer Diameter	Cable Entry	Max. Poss. Cable Outer Diameter	No. Main Terminals	Max. Conn. Cross-Section per Terminal	Max. Poss. Current per Terminal <sup>1)</sup>	
				Valid for Position 8 of Order No.: "2", "4" or "6" <sup>3)</sup>	Valid for Position 8 of Order No.: "7" or "8"					
				mm (in)		mm (in) <sup>2)</sup>			A	
<b>1PL6 Motors</b>										
180	1PL6184...B	1XB7322	2 x PG 42	40 (1.57)	2 x M 50 x 1.5	38 (1.5)	3 x M 12	2 x 50	191	
	1PL6184...D	1XB7322	2 x PG 42	40 (1.57)	2 x M 50 x 1.5	38 (1.5)	3 x M 12	2 x 50	191	
	1PL6184...F	1XB7322	2 x PG 42	40 (1.57)	2 x M 50 x 1.5	38 (1.5)	3 x M 12	2 x 50	191	
	1PL6184...L	1XB7422	2 x M 72 x 2	56 (2.2)	2 x M 63 x 1.5	53 (2.09)	3 x M 12	2 x 70	242	
	1PL6186...B	1XB7322	2 x PG 42	40 (1.57)	2 x M 50 x 1.5	38 (1.5)	3 x M 12	2 x 50	191	
	1PL6186...D	1XB7322	2 x PG 42	40 (1.57)	2 x M 50 x 1.5	38 (1.5)	3 x M 12	2 x 50	191	
	1PL6186...F	1XB7422	2 x M 72 x 2	56 (2.2)	2 x M 63 x 1.5	53 (2.09)	3 x M 12	2 x 70	242	
	1PL6186...L	1XB7700	3 x M 72 x 2	56 (2.2)	3 x M 75 x 1.5	68 (2.68)	3 x 2 x M 12	3 x 150	583	
225	1PL6224...B	1XB7322	2 x PG 42	40 (1.57)	2 x M 50 x 1.5	38 (1.5)	3 x M 12	2 x 50	191	
	1PL6224...D	1XB7422	2 x M 72 x 2	56 (2.2)	2 x M 63 x 1.5	53 (2.09)	3 x M 12	2 x 70	242	
	1PL6224...F	1XB7700	3 x M 72 x 2	56 (2.2)	3 x M 75 x 1.5	68 (2.68)	3 x 2 x M 12	3 x 150	583	
	1PL6224...L	1XB7700	3 x M 72 x 2	56 (2.2)	3 x M 75 x 1.5	68 (2.68)	3 x 2 x M 12	3 x 150	583	
	1PL6226...B	1XB7322	2 x PG 42	40 (1.57)	2 x M 50 x 1.5	38 (1.5)	3 x M 12	2 x 50	191	
	1PL6226...D	1XB7700	3 x M 72 x 2	56 (2.2)	3 x M 75 x 1.5	68 (2.68)	3 x 2 x M 12	3 x 150	583	
	1PL6226...F	1XB7700	3 x M 72 x 2	56 (2.2)	3 x M 75 x 1.5	68 (2.68)	3 x 2 x M 12	3 x 150	583	
	1PL6226...L	1XB7700	3 x M 72 x 2	56 (2.2)	3 x M 75 x 1.5	68 (2.68)	3 x 2 x M 12	3 x 150	583	
	1PL6228...B	1XB7322	2 x PG 42	40 (1.57)	2 x M 50 x 1.5	38 (1.5)	3 x M 12	2 x 50	191	
	1PL6228...D	1XB7700	3 x M 72 x 2	56 (2.2)	3 x M 75 x 1.5	68 (2.68)	3 x 2 x M 12	3 x 150	583	
	1PL6228...F	1XB7700	3 x M 72 x 2	56 (2.2)	3 x M 75 x 1.5	68 (2.68)	3 x 2 x M 12	3 x 150	583	
	1PL6228...L	1XB7700	3 x M 72 x 2	56 (2.2)	3 x M 75 x 1.5	68 (2.68)	3 x 2 x M 12	3 x 150	583	
280	1PL628.	1XB7712	4 x M 75 x 1.5	68 (2.68)	–	–	(3+1) <sup>4)</sup> x 4 x M 16	4 x 185	925	

#### Notes on Cable Glands

Cable glands and EMC cable glands for shielded cables with PG or metric threads and conversion pieces from PG to metric threads can be obtained from the following companies:

HUGRO-Armaturen GmbH  
Rudolf-Blessing-Str. 5  
D-79183 Waldkirch, Germany  
Tel. +49 (0) 76 81/40 73-0  
Fax +49 (0) 76 81/40 73-40  
E-mail: info@hugro-gmbh.de  
www.hugro-gmbh.de

- EMC cable glands
- Cable glands with heavy-gauge conduit thread
- Metric cable glands
- Conversion pieces PG ↔ metric

Pflitsch GmbH & Co. KG  
P.O. Box 10 03 51  
D-42492 Hückeswagen, Germany  
Tel. +49 (0) 21 92-91 10  
Fax +49 (0) 21 92-91 12 11

- Cable glands up to PG 42
- Screw plugs/  
Filler plugs

1) Current-carrying capacity based on IEC 60204-1, Routing Type C.  
2) Depends on type of metric cable gland.

3) Not for shaft height 280.  
4) Including ground terminal.

# Servo Motors for SIMOVERT MASTERDRIVES



## Engineering Information

### Additional Data for Motors 1PH7 and 1PL6

#### Overview of Available Construction Types

Motors 1PH7 and 1PL6 are available in construction types IM B3 (standard model), IM B5, and IM B35. Other construction types (IM V15, IM V36, IM B6, IM B7, IM B8 etc.) are also available. When ordering the motors with shaft heights 180 and 225 from the factory, the correct number of lifting lugs for the intended mounting position should be specified (position 12 in the motor order number). For motors with shaft heights 100 to 160, the internal lifting lugs can be converted for other mounting schemes.

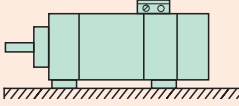
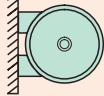
**Note:** There are no condensate drain holes in the motors.

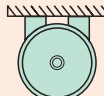
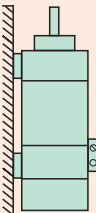
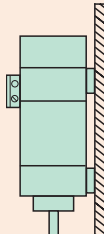
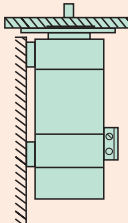
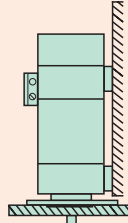
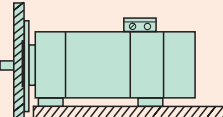
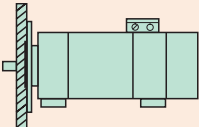
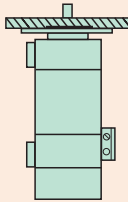
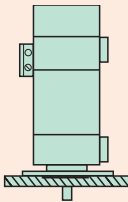
Type of construction	Type of construction	1	2	3	4	5	6	7	8	9	10	11	12
 <p><b>IM B 3</b></p>	 <p><b>IM B 6</b></p>												1
		Foot Mounting Type (≅ IM B 3)											
		0											
 <p><b>IM B 7</b></p>	 <p><b>IM B 8</b></p>												1
		Foot Mounting Type (≅ IM B 3)											
		1											
 <p><b>IM V 6</b></p>	 <p><b>IM V 5</b></p>												1
		Foot-Flange Mounting Type (≅ IM B 35)											
		1											
 <p><b>IM V 36<sup>1)</sup></b></p>	 <p><b>IM V 15<sup>1)</sup></b></p>												5
		Foot-Flange Mounting Type (≅ IM B 35)											
		5											
 <p><b>IM B 35<sup>1)</sup></b></p>													3
		Foot-Flange Mounting Type (≅ IM B 35)											
		3											
 <p><b>IM B 5</b></p>	 <p><b>IM V 3</b></p>	 <p><b>IM V 1</b></p>											2
		Flange Mounting Type (≅ IM B 5)											
		2											

1) Foot and flange mounting required.

# Appendix

# A

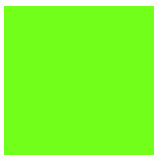

<b>A/2</b>	<b>Environment, Resources and Recycling</b>
<b>A/2</b>	<b>Order Number Index</b>
<b>A/3</b>	<b>Subject Index</b>
<b>A/4</b>	<b>Siemens Companies and Representatives Worldwide</b>
<b>A/5</b>	<b>Information and Ordering Options on the Internet and on CD-ROM</b>
<b>A/6</b>	<b>Customer Support</b>
<b>A/11</b>	<b>Conditions of Sale and Delivery</b>
<b>A/11</b>	<b>Export Regulations</b>
<b>A/12</b>	<b>Fax Order Form for PATH PLUS Demo Version</b>



# Servo Motors for SIMOVERT MASTERDRIVES

## Appendix

### Environment, Resources and Recycling EU Declarations of Conformity

Siemens AG has a responsibility to protect the environment and conserve natural resources. This is true for both our production processes and our products.

Even during development, we consider any possible environmental impact of future products/systems. Our aim is to prevent harmful environmental effects or at least to reduce them to an absolute minimum – beyond present regulations and legislation.

The most important activities for protecting our environment:

Use of hazardous substances (e.g. arsenic, asbestos, beryllium, cadmium, CFCs, halogen, to name just a few) was avoided even in the development stage

Parts are designed for easy disassembly, and materials of the highest quality are used. Moreover, recyclable materials or materials that can be disposed of safely are used whenever possible.

During production, the proper recycling method is identified for each material. This is especially the case for components for which use of hazardous materials cannot be avoided. Such components are made to be easily removed to facilitate environmentally correct disposal. Whenever possible, recycled parts are used.

For shipping and storage, non-ecological packaging materials (plywood and polyethylene film) are used as little as possible. Whenever possible, we use reusable packaging.

We have already made preparations to dispose of used equipment in accordance with the "ESVO" electronic scrap ordinance (which has not yet been enacted).

All of our documentation is printed on chlorine-free bleached paper.

All divisions of Siemens AG A&D are certified.

### Order Number Index

	Page
<b>1FK</b>	
1FK7	2/4
1FK702.	2/4
1FK703.	2/4, 4/13
1FK704.	2/4, 4/13
1FK706.	2/4, 4/13
1FK708.	2/4, 4/15
1FK710.	2/4, 4/15
<b>1FS</b>	
1FS6	2/34
1FS6074	2/34
1FS6096	2/34
1FS6115	2/34
1FS6134	2/34
<b>1FT</b>	
1FT6	2/10
1FT602.	2/20
1FT603.	2/10
1FT604.	2/10
1FT606.	2/10
1FT608.	2/10
1FT610.	2/10
1FT613.	2/14
1FT616.	2/26
<b>1FW3</b>	
1FW3	2/38
1FW320.	2/38
1FW328.	2/38
<b>1PH</b>	
1PH4	3/72, 3/74
1PH410.	3/72, 3/74
1PH413.	3/72, 3/74
1PH416.	3/72, 3/74
1PH7	3/4
1PH710.	3/4
1PH713.	3/4
1PH716.	3/4
1PH718.	3/8
1PH722.	3/8
1PH728.	3/12

	Page
<b>1PL</b>	
1PL6	3/46, 3/52
1PL618.	3/46, 3/52
1PL622.	3/46, 3/52
1PL628.	3/50, 3/56
<b>6FX</b>	
6FX.002	5/13
6FX.008	5/17
6FX2003	5/10
6FX5002	5/6
6FX5008	5/6
6FX7002	5/8
6FX8002	5/6
6FX8008	5/6
<b>2LG</b>	
2LG4250	4/43
2LG4260	4/43
2LG4312	4/43
2LG4315	4/43
2LG4320	4/43
<b>LP</b>	
LP050	4/37
LP070	4/37
LP090	4/37
LP120	4/37
LP155	4/37
<b>SP</b>	
SP060	4/39
SP075	4/39
SP100	4/39
SP140	4/39
SP180	4/39
SP210	4/39
SP240	4/39

	Page		Page
<b>A</b>		<b>R</b>	
Absolute encoder	4/3	Radial eccentricity tolerance	1/13
Additional data for 1PH7 and 1PL6 motors	7/1 to 7/8	Rated torque	1/16
Appendix	A/1	Ratings	1/10, 1/11
Asynchronous servo motors	3/1	Recycling	A/2
1PH4 asynchronous servo motors	3/70 to 3/75	Regulations	1/12
1PH7 asynchronous servo motors	3/2 to 3/43	Resources	A/2
1PL6 asynchronous servo motors	3/44 to 3/69		
Automation landscape	1/7	<b>S</b>	
Axial eccentricity tolerance	1/13	Selection and ordering data	
		Planetary gearbox	4/36 to 4/40
<b>B</b>		Signal cables	5/11 to 5/16
Balancing	1/14	1FK7 synchronous servo motors	2/4
Bearing design	7/3	1FT6 synchronous servo motors	2/10
Bearing lifetime	7/3	1FS6 synchronous servo motors	2/34
Brakes	4/4 to 4/8	1FW3 synchronous servo motors	2/38
Brief description	1/6, 1/7	1PH4 asynchronous servo motors	3/72 to 3/75
		1PH7 asynchronous servo motors	3/4 to 3/41
<b>C</b>		1PL6 asynchronous servo motors	3/46 to 3/67
Cable configuration and connector assignment	5/13 to 5/16	6FX5 and 6FX8 power cables	5/6 to 5/10
Cable cross-sections, maximum connectable	7/6, 7/7	Servo geared motors	4/9 to 4/35
Cables	5/2	Servo motors	2/1 to 2/39,
Cables and connections	5/1 to 5/17		3/1 to 3/75
Cantilever force diagrams	7/4, 7/5	1FK7	2/2
Concentricity tolerance	1/13	1FS6	2/32
Conditions of sale and delivery	A/11	1FT6	2/8
Construction types	7/8	1PH4	3/70 to 3/75
Contacts	A/4	1PH7	3/2 to 3/41
Continuous operation periodic duty	1/15	1PL6	3/44 to 3/67
Continuous running duty	1/15	Shaft and flange accuracy	1/13
Coolant temperature	1/12	Signal cables	5/11 to 5/16
Customer support	A/6	Signal cables for connection to motors with	
		absolute encoder (EnDat)	5/16
<b>D</b>		Signal cables for connection to motors with	
Degrees of protection	1/12	encoder HTL	5/13
Documentation	6/1	Signal cables for connection to motors with	
Drive type	7/3	encoder sin/cos 1 V <sub>pp</sub>	5/15
DURIGNIT IR2000	1/16	Signal cables for connection to motors with	
		2-pole/multipole resolver	5/14
<b>E</b>		SIMOVERT MASTERDRIVES Motion Control	
Encoder systems	4/2, 4/3	connection overview	5/12
Engineering information	7/1	SIMOVERT MASTERDRIVES Vector Control	
Environment	A/2	connection overview	5/12
		Sound pressure level	7/2
<b>F</b>		Specifications	1/12
Flowchart for selection procedure	1/8	Standards	1/12
		Synchronous servomotors	2/1 to 2/39
<b>G</b>		1FK7	2/2
Gearbox mounting	4/36 to 4/43	1FS6	2/32
Geared motors	4/9 to 4/35	1FT6	2/8
		1FW3	2/36
<b>H</b>		<b>T</b>	
Holding brakes	4/4 to 4/8	Technical Data	
Holding brakes for 1FK7 and 1FT6 motors	4/4	Absolute encoder (EnDat)	4/3
Holding brakes for 1PH7 motors	4/6 to 4/8	Holding brake	4/5, 4/7
		Incremental encoder HTL	4/2
<b>I</b>		Incremental encoder sin/cos 1 V <sub>pp</sub>	4/3
Incremental encoder	4/2, 4/3	Servo geared motors	4/10 to 4/35
Installation altitude	1/14	Signal cables	5/11 to 5/16
Insulation DURIGNIT IR2000	1/16	1FK7 synchronous servo motors	2/3
Integration of motors in the automation landscape	1/7	1FT6 synchronous servo motors	2/9
		1FS6 synchronous servo motors	2/33
<b>M</b>		1FW3 synchronous servo motors	2/37
Maximum speeds	7/3	1PH4 asynchronous servo motors	3/71
MOTION-CONNECT	5/1	1PH7 asynchronous servo motors	3/3
Motor protection	1/16	1PL6 asynchronous servo motors	3/45
Motors in the automation landscape	1/7	2-pole/multipole resolver	4/2
Mounted parts	4/1	6FX5 and 6FX8 power cables	5/2
		Technical definitions	1/12 to 1/16
<b>N</b>		Terminal box assignment	7/6, 7/7
Nameplates	1/15	Torque motors	2/36
		Two-speed gear-change gearbox (ZF)	4/41 to 4/43
<b>O</b>		Type overview and ratings	1/10, 1/11
Operating instructions	6/2	<b>V</b>	
Operating modes	1/15	Ventilation data	7/2
Options for		Vibration severity levels	1/13
1FK7	2/3	Vibration stress, imitted vibration values	1/14
1FT6	2/9		
1PH4	3/71	<b>W</b>	
1PH7	3/3	Water-cooled 1PH4 asynchronous servo motors	3/70
1PL6	3/45		
Order number key for 1FT6 and 1PH7 motors	4/7 to 4/8	2-pole/multipole resolver	4/2
with holding brake	1/1	6FX5 and 6FX8 power cables	5/6 to 5/10
Overview	1/1		
Overview of available construction types	7/8		
<b>P</b>			
Paint finish	1/16		
PATH	0/2		
PATH configuration guide	0/2		
Permanent lubrication	7/3		
Planetary gearbox	4/36 to 4/40		
Planning guides	6/2		
Power cables	5/6 to 5/10		
Power cables for 1FK., 1FT6, 1FS6, 1PH., 1PL6	5/6, 5/7		

# Servo Motors for SIMOVERT MASTERDRIVES

## Appendix

### Siemens Contacts Worldwide



Visit

[www.siemens.com/automation/partner](http://www.siemens.com/automation/partner)

where you can find Siemens contacts for specific technologies worldwide.

Wherever possible, you can find a local contact for

- Technical support
- Spare parts/repairs
- Service
- Training
- Sales or
- Technical support/engineering

The selection procedure starts with

- a country
- a product or
- a sector.

When the remaining criteria have been specified, the required contact will be shown complete with his/her respective expertise.



### Information and Ordering Options on the Internet and on CD-ROM

#### A&D in the WWW



A detailed knowledge of the range of products and services available is essential when planning and configuring automation systems. It goes without saying that this information must always be fully up-to-date.

The Siemens Automation and Drives Group (A&D) has therefore built up a comprehensive range of information in the World Wide Web which offers quick and easy access to all data required.

Visit

<http://www.siemens.com/automation>

where you will find everything you need to know about products, systems and services.

#### Product selection using the interactive catalog

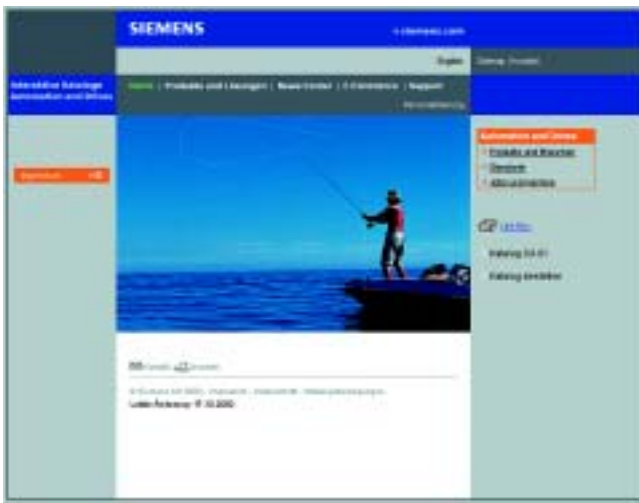

Detailed information together with convenient interactive functions:

The interactive catalog CA 01 covers more than 80,000 products and thus provides a full summary of the Siemens Automation and Drives product base.

Here you will find everything that you need to solve tasks in the fields of automation, switchgear, installation and drives. All information is linked into a user interface which is easy to work with and intuitive.

After selecting the product of your choice you can order at the press of a button by fax or by online link

Information on the interactive catalogs can be found on the Internet at

<http://www.siemens.com/automation/ca01>

or on CD-ROM:

- Automation & Drives CA 01,  
Order No.: E86060-D4001-A110-C2-7600

#### Easy shopping with the A&D Mall



The A&D Mall is the virtual department store of Siemens AG in the Internet. Here you have access to a huge range of products presented in electronic catalogs in an informative and attractive way.

Data transfer via EDIFACT allows the whole procedure from selection through ordering to tracking of the order to be carried out online via the Internet.

Numerous functions are available to support you.

For example, powerful search functions make it easy to find the required products which can be immediately checked for availability. Customer-specific discounts and preparation of quotes can be carried out online as well as order tracking and tracing.

Please visit the A&D Mall on the Internet under:

<http://www.siemens.com/automation/mall>





# Servo Motors for SIMOVERT MASTERDRIVES

## Appendix

### Customer support



In tough competition, you need optimal conditions if you want to stay in the lead: a strong starting position, an ingenious strategy and an excellent support team – at every stage. Service & Support from Siemens provides this support with a full palette of different services for automation and drives.

At every stage: From the planning stage through commissioning as far as maintenance and modernization.

Our specialists know exactly where they have to act in order to maintain the productivity and efficiency of your plant.

### Online support



The comprehensive Internet-based information system, which is available round the clock, provides product support, services, and support tools in the shop.

<http://www.siemens.com/automation/service&support>

### Technical support



Competent advice for technical questions with a broad spectrum of carefully tailored services extending beyond our products and systems.

**Tel.: +49 (0)180 50 50 222**  
**Fax: +49 (0)180 50 50 223**

E-mail: [ad.support@siemens.com](mailto:ad.support@siemens.com)

### Technical Consulting



Support with the planning and design of your project: From detailed analysis of the current situation through advice on products and systems through to designing the automation solution. <sup>1)</sup>

### Project Engineering and Software Engineering



Support with project engineering and development with services tailored to requirements from configuration through to implementation of an automation project. <sup>1)</sup>

### Field service



Field service provides services for commissioning and repair which are an important prerequisite for guaranteeing availability.

In Germany Tel.: **0180 50 50 444** <sup>1)</sup>

### Spare Parts and Repairs



During normal operation of a machine or automation system, we provide a comprehensive spare parts and repair service that provides you with the best possible operational reliability.

In Germany Tel.: **0180 50 50 446** <sup>1)</sup>

### Optimization and Modernization



To increase productivity or to save costs in your project, we offer high-quality services for optimization and modernization. <sup>1)</sup>

<sup>1)</sup> You will find telephone numbers for other countries on our Internet site <http://www.siemens.com/automation/service&support>

#### Rotary inertia (to convert from A to B, multiply by entry in table)

A \ B	lb-in <sup>2</sup>	lb-ft <sup>2</sup>	lb-in-s <sup>2</sup>	lb-ft-s <sup>2</sup> slug-ft <sup>2</sup>	Kg-cm <sup>2</sup>	Kg-cm-s <sup>2</sup>	gm-cm <sup>2</sup>	gm-cm-s <sup>2</sup>	oz-in <sup>2</sup>	oz-in-s <sup>2</sup>
lb-in <sup>2</sup>	1	$6.94 \times 10^{-3}$	$2.59 \times 10^{-3}$	$2.15 \times 10^{-4}$	2.926	$2.98 \times 10^{-3}$	$2.92 \times 10^3$	2.984	16	$4.14 \times 10^{-2}$
lb-ft <sup>2</sup>	144	1	0.3729	$3.10 \times 10^{-2}$	421.40	0.4297	$4.21 \times 10^5$	429.71	2304	5.967
lb-in-s <sup>2</sup>	386.08	2.681	1	$8.33 \times 10^{-2}$	$1.129 \times 10^3$	1.152	$1.129 \times 10^6$	$1.152 \times 10^3$	$6.177 \times 10^3$	16
lb-ft-s <sup>2</sup> slug-ft <sup>2</sup>	$4.63 \times 10^3$	32.17	12	1	$1.35 \times 10^{-4}$	13.825	$1.355 \times 10^7$	$1.38 \times 10^4$	$7.41 \times 10^{-4}$	192
Kg-cm <sup>2</sup>	0.3417	$2.37 \times 10^{-3}$	$8.85 \times 10^{-4}$	$7.37 \times 10^{-5}$	1	$1.019 \times 10^{-3}$	1000	1.019	5.46	$1.42 \times 10^{-2}$
Kg-cm-s <sup>2</sup>	335.1	2.327	0.8679	$7.23 \times 10^{-2}$	980.66	1	$9.8 \times 10^5$	1000	$5.36 \times 10^3$	13.887
gm-cm <sup>2</sup>	$3.417 \times 10^{-4}$	$2.37 \times 10^{-6}$	$8.85 \times 10^{-7}$	$7.37 \times 10^{-8}$	$1 \times 10^{-3}$	$1.01 \times 10^{-6}$	1	$1.01 \times 10^{-3}$	$5.46 \times 10^{-3}$	$1.41 \times 10^{-5}$
gm-cm-s <sup>2</sup>	0.335	$2.32 \times 10^{-3}$	$8.67 \times 10^{-4}$	$7.23 \times 10^{-5}$	0.9806	$1 \times 10^{-3}$	980.6	1	5.36	$1.38 \times 10^{-2}$
oz-in <sup>2</sup>	0.0625	$4.34 \times 10^{-4}$	$1.61 \times 10^{-4}$	$1.34 \times 10^{-5}$	0.182	$1.86 \times 10^{-4}$	182.9	0.186	1	$2.59 \times 10^{-3}$
oz-in-s <sup>2</sup>	24.13	0.1675	$6.25 \times 10^{-2}$	$5.20 \times 10^{-3}$	70.615	$7.20 \times 10^{-2}$	$7.09 \times 10^4$	72.0	386.08	1

#### Torque (to convert from A to B, multiply by entry in table)

A \ B	lb-in	lb-ft	oz-in	N-m	Kg-cm	Kg-m	gm-cm	dyne-cm
lb-in	1	$8.333 \times 10^{-2}$	16	0.113	1.152	$1.152 \times 10^{-2}$	$1.152 \times 10^3$	$1.129 \times 10^6$
lb-ft	12	1	192	1.355	13.825	0.138	$1.382 \times 10^4$	$1.355 \times 10^7$
oz-in	$6.25 \times 10^{-2}$	$5.208 \times 10^{-3}$	1	$7.061 \times 10^{-3}$	$7.200 \times 10^{-2}$	$7.200 \times 10^{-4}$	72.007	$7.061 \times 10^7$
N-m	8.850	0.737	141.612	1	10.197	0.102	$1.019 \times 10^4$	$1 \times 10^7$
Kg-cm	0.8679	$7.233 \times 10^{-2}$	13.877	$9.806 \times 10^{-2}$	1	$10^{-2}$	1000	$9.806 \times 10^5$
Kg-m	86.796	7.233	$1.388 \times 10^3$	9.806	100	1	$1 \times 10^5$	$9.806 \times 10^7$
gm-cm	$8.679 \times 10^{-4}$	$7.233 \times 10^{-5}$	$1.388 \times 10^{-2}$	$9.806 \times 10^{-5}$	$1 \times 10^{-3}$	$1 \times 10^{-5}$	1	980.665
dyne-cm	$8.850 \times 10^{-7}$	$7.375 \times 10^{-8}$	$1.416 \times 10^{-5}$	$10^{-7}$	$1.0197 \times 10^{-6}$	$1.019 \times 10^{-8}$	$1.019 \times 10^{-3}$	1

#### Length (to convert from A to B, multiply by entry in table)

A \ B	Inches	feet	cm	yd	mm	m
Inches	1	0.0833	2.54	0.028	25.4	0.0254
feet	12	1	30.48	0.333	304.8	0.3048
cm	0.3937	0.03281	1	$1.09 \times 10^{-2}$	10	0.01
yd	36	3	91.44	1	914.4	0.914
mm	0.03937	0.00328	0.1	$1.09 \times 10^{-3}$	1	0.001
m	39.37	3.281	100	1.09	1000	1

#### Force (to convert from A to B, multiply by entry in table)

A \ B	lb	oz	gm	dyne	N
lb	1	16	453.6	$4.448 \times 10^{-5}$	4.4482
oz	0.0625	1	28.35	$2.780 \times 10^{-4}$	0.27801
gm	$2.205 \times 10^{-3}$	0.03527	1	$1.02 \times 10^{-3}$	N.A.
dyne	$2.248 \times 10^{-6}$	$3.59 \times 10^{-5}$	890.7	1	0.00001
N	0.22481	3.5967	N.A.	100.000	1

#### Mass (to convert from A to B, multiply by entry in table)

A \ B	lb	oz	gm	slug
lb	1	16	453.6	0.0311
oz	$6.25 \times 10^{-2}$	1	28.35	$1.93 \times 10^{-3}$
gm	$2.205 \times 10^{-3}$	$3.527 \times 10^{-3}$	1	$6.852 \times 10^{-5}$
slug	32.17	514.8	$1.459 \times 10^4$	1

#### Power (to convert from A to B, multiply by entry in table)

A \ B	H.P.	Watts
H.P. (English)	1	745.7
(lb-in)(deg./sec)	$2.645 \times 10^{-6}$	$1.972 \times 10^{-3}$
(lb-in)(RPM)	$1.587 \times 10^{-5}$	$1.183 \times 10^{-2}$
(lb-ft)(deg./sec)	$3.173 \times 10^{-5}$	$2.366 \times 10^{-2}$
(lb-ft)(RPM)	$1.904 \times 10^{-4}$	0.1420
Watts	$1.341 \times 10^{-3}$	1

#### Rotation (to convert from A to B, multiply by entry in table)

A \ B	RPM	rad/sec.	degrees/sec.
RPM	1	0.105	6.0
rad/sec.	9.55	1	57.30
degrees/sec.	0.167	$1.745 \times 10^{-2}$	1

# Servo Motors for SIMOVERT MASTERDRIVES

## Appendix

### Conversion tables

#### Temperature conversion

°F	°C	°C	°F
0	-17.8	-10	14
32	0	0	32
50	10	10	50
70	21.1	20	68
90	32.2	30	86
98.4	37	37	98.4
212	100	100	212
subtract 32 and multiply by $\frac{5}{9}$		multiply by $\frac{9}{5}$ and add 32	

#### Mechanism Efficiencies

Acme-screw with brass nut	~0.35–0.65
Acme-screw with plastic nut	~0.50–0.85
Ball-screw	~0.85–0.95
Chain and Sprocket	~0.95–0.98
Preloaded Ball-screw	~0.75–0.85
Spur or Bevel-gears	~0.90
Timing Belts	~0.96–0.98
Worm Gears	~0.45–0.85
Helical Gear (1 reduction)	~0.92

#### Friction Coefficients

Materials	$\mu$
Steel on Steel (greased)	~0.15
Plastic on Steel	~0.15–0.25
Copper on Steel	~0.30
Brass on Steel	~0.35
Aluminium on Steel	~0.45
Steel on Steel	~0.58
Mechanism	$\mu$
Ball Bushings	<0.001
Linear Bearings	<0.001
Dove-tail slides	~0.2++
Gibb Ways	~0.5++

#### Material Densities

Material	lb-in <sup>3</sup>	gm-cm <sup>3</sup>
Aluminium	0.096	2.66
Brass	0.299	8.30
Bronze	0.295	8.17
Copper	0.322	8.91
Hard Wood	0.029	0.80
Soft Wood	0.018	0.48
Plastic	0.040	1.11
Glass	0.079–0.090	2.2–2.5
Titanium	0.163	4.51
Paper	0.025–0.043	0.7–1.2
Polyvinyl chloride	0.047–0.050	1.3–1.4
Rubber	0.033–0.036	0.92–0.99
Silicone rubber, without filler	0.043	1.2
Cast iron, grey	0.274	7.6
Steel	0.280	7.75

#### Wire Gauges <sup>1)</sup>

Cross-Section mm <sup>2</sup>	Standard Wire Gauge (SWG)	American Wire Gauge (AWG)
0.2	25	24
0.3	23	22
0.5	21	20
0.75	20	19
1.0	19	18
1.5	17	16
2.5	15	13
4	13	11
6	12	9
10	9	7
16	7	6
25	5	3
35	3	2
50	0	1/0
70	000	2/0
95	00000	3/0
120	0000000	4/0
150	–	6/0
185	–	7/0

1) Table shows approximate SWG/AWG sizes nearest to standard metric sizes; the cross-sections do not match exactly.





# Servo Motors for SIMOVERT MASTERDRIVES

## Appendix

Notes

#### Terms and Conditions of Sale and Delivery

By using this catalog you can acquire hardware and software products described therein from the Siemens AG subject to the following terms. Please note! The scope, the quality and the conditions for supplies and services, including software products, by any Siemens entity having a registered office outside of Germany, shall be subject exclusively to the General Terms and Conditions of the respective Siemens entity.

#### *for customers with a seat or registered office in the Federal Republic of Germany*

The General Terms of Payment as well as the General Conditions for the Supply of Products and Services of the Electrical and Electronics Industry shall apply.

For software products, the General License Conditions for Software Products for Automation and Drives for Customers with Seat or registered Office in Germany shall apply.

#### *for customers with a seat or registered office outside of Germany*

The General Terms of Payment as well as the General Conditions for Supplies of Siemens, Automation and Drives for Customers with a Seat or registered Office outside of Germany shall apply.

For software products, the General License Conditions for Software Products for Automation and Drives for Customers with Seat or registered Office outside of Germany shall apply.

#### **General**

The prices are in € (Euro) ex works, exclusive packaging.

The sales tax (value added tax) is not included in the prices. It shall be debited separately at the respective rate according to the applicable legal regulations.

In addition to the prices of products which include silver and/or copper, surcharges may be calculated if the respective limits of the notes are exceeded.

Prices are subject to change without prior notice. We will debit the prices valid at the time of delivery.

The dimensions are in mm (inches). Illustrations are not binding.

Insofar as there are no remarks on the corresponding pages, - especially with regard to data, - dimensions and weights given - these are subject to change without prior notice.

Comprehensive Terms and Conditions of Sale and Delivery are available free of charge from your local Siemens business office under the following Order Nos.:

- 6ZB5310-OKR30-0BA0  
(for customers based in the Federal Republic of Germany)
- 6ZB5310-OKS53-0BA0  
(for customers based outside of the Federal Republic of Germany)

or download them from the Internet:

[www.siemens.com/automation/mall](http://www.siemens.com/automation/mall)  
(Germany: A&D Mall Online-Help System)

Siemens AG  
Automation and Drives  
[Motion Control Systems](#)  
Postfach 31 80  
91050 ERLANGEN  
FEDERAL REPUBLIC OF GERMANY

#### Export regulations

The products listed in this catalog/price list may be subject to European/German and/or US export regulations.

Therefore, any export requiring a license is subject to approval by the competent authorities.

According to current provisions, the following export regulations must be observed with respect to the products featured in this catalog/price list:

AL	Number of the <u>German Export List</u> . Products marked other than "N" require an export license. In the case of software products, the export designations of the relevant data medium must also be generally adhered to. Goods labeled with an " <u>AL not equal to N</u> " are subject to a European or German export authorization when being exported out of the EU.
ECCN	<u>Export Control Classification Number</u> . Products marked other than "N" are subject to a reexport license to specific countries. In the case of software products, the export designations of the relevant data medium must also be generally adhered to. Goods labeled with an " <u>ECCN not equal to N</u> " are subject to a US re-export authorization.

Even without a label or with an "AL: N" or "ECCN: N", authorization may be required due to the final destination and purpose for which the goods are to be used.

The deciding factors are the AL or ECCN export authorization indicated on order confirmations, delivery notes and invoices.

Errors excepted and subject to change without prior notice.

A&D/VuL/En 14.11.03

Responsible for  
Technical contents:  
Siemens AG, A&D MC PM 4, Erlangen  
General editing:  
Siemens AG, A&D PT 5, Erlangen,  
Federal Republic of Germany

Order No.  
**E86060-K5465-A301-A2-7600**  
KG K 0804 15.0 E 220 En/422324  
Printed in the Federal Republic of Germany

# Servo Motors for SIMOVERT MASTERDRIVES

## Appendix

Fax Order Form for PATH PLUS Demo Version

## *Fax Order*

### AD/Z330

Please send me the PATH Plus demo version free of charge

Please send me the latest information about SIMOVERT MASTERDRIVES

Motion Control

Vector Control

Siemens AG Info Service  
P.O. Box 23 48  
90713 Fürth Germany

**Fax No.: +49 (0) 9 11/9 78-33 21**

Company \_\_\_\_\_

Department \_\_\_\_\_

Name \_\_\_\_\_

Street \_\_\_\_\_

City State/Province, ZIP/Postal Code \_\_\_\_\_

I can be reached at the following daytime telephone number:

\_\_\_\_\_

Telephone \_\_\_\_\_

Fax \_\_\_\_\_

E-mail \_\_\_\_\_

Date \_\_\_\_\_

Signature \_\_\_\_\_



# Catalogs of the Automation and Drives Group (A&D)

Please send any request to your Siemens representative  
Addresses can be found at <http://www.siemens.com/automation/partner>

<b>Automation and Drives</b>	<i>Catalog</i>	
Interactive catalog on CD-ROM		
• The Offline Mall of Automation and Drives	CA 01	
<b>Automation Systems for Machine Tools</b>		
SINUMERIK & SIMODRIVE	NC 60	
<b>Drive Systems</b>		
<u>Variable-Speed Drives</u>		
SINAMICS G130 Drive Converter Chassis Units	D 11	
SINAMICS G150 Drive Converter Chassis Units		
SINAMICS G110 Inverter Chassis Units	D 11.1	
SINAMICS S120 Servo Control Drive System	D 21.2	
SINAMICS S150 Drive Converter Cabinet Units	D 21.3	
DC Motors	DA 12	
DC Drives Preferred Series up to 500 kW	DA 12.1	
DC Drives Preferred Series 215 kW to 1500 kW	DA 12.2	
SIMOREG DC MASTER 6RA70 Digital Chassis Converters	DA 21.1	
SIMOREG K 6RA22 Analog Chassis Converters	DA 21.2	
SIMOREG DC MASTER 6RM70 Digital Converter Cabinet Units	DA 22	
SIMOVERT PM Modular Converter Systems	DA 45	
SIEMOSYN Motors	DA 48	
MICROMASTER 410/420/430/440 Inverters	DA 51.2	
MICROMASTER 411/COMBIMASTER 411	DA 51.3	
SIMOVERT MV Medium-Voltage Drives	DA 63	
SIMOVERT MASTERDRIVES Vector Control	DA 65.10	
SIMOVERT MASTERDRIVES Motion Control	DA 65.11	
Synchronous and asynchronous servomotors for SIMOVERT MASTERDRIVES	DA 65.3	
SIMODRIVE 611 universal and POSMO	DA 65.4	
<u>Low-Voltage Three-Phase-Motors</u>		
Project Manual	M 10	
Squirrel-Cage Motors, Totally Enclosed, Fan-Cooled	M 11	
<u>Automation Systems for Machine Tools SIMODRIVE</u>	NC 60	
• Main Spindle Motors		
• Feed Motors		
• Converter Systems SIMODRIVE 611/POSMO		
<u>Drive and Control Components for Hoisting Equipment</u>	HE 1	
<b>Electrical Installation Technology</b>		
<i>PDF: ALPHA Small Distribution Boards and Distribution Boards</i>	ETA 1	
<i>PDF: ALPHA Side-by-Side Switchgear Cabinets</i>	ETA 3	
<i>PDF: ALPHA FIX Terminal Blocks</i>	ETA 5	
<i>PDF: BETA Modular Installation Devices</i>	ET B1	
<i>PDF: DELTA Switches and Outlets</i>	ET D1	
<i>PDF: GAMMA Building Management Systems</i>	ET G1	
<b>Factory Automation Sensors</b>	FS 10	
<b>Human Machine Interface Systems SIMATIC HMI</b>	ST 80	
<b>Industrial Communication for Automation and Drives</b>		<i>Catalog</i> IK PI
<b>Low-Voltage Controls and Distribution</b>		
Low-Voltage Switchgear – Controlgear for Industry	LV 10	
Power Distribution – Products and Systems for Low-Voltage Power Distribution	LV 30	
SIVACON 8PS Busbar Trunking Systems CD, BD01, BD2 up to 1250 A	LV 70	
SETRON WL	NS WL	
<b>Motion Control System SIMOTION</b>	PM 10	
<b>Process Instrumentation and Analytics</b>		
Field Instruments for Process Automation	FI 01	
Measuring Instruments for Pressure, Differential Pressure, Flow, Level and Temperature, Positioners and Liquid Meters		
<i>PDF: Indicators for panel mounting</i>	MP 12	
SIREC Recorders and Accessories	MP 20	
SIPART, Controllers and Software	MP 31	
SIWAREX Weighing Systems	WT 01	
Continuous Weighing and Process Protection	WT 02	
Gas Analysis Equipment for the Process Industry	PA 10	
<i>PDF: Process Analytics, Components for the System Integration</i>	PA 11	
SIPAN Liquid Analysis	PA 20	
<b>SIMATIC Industrial Automation Systems</b>		
SIMATIC PCS Process Control System	ST 45	
<i>PDF: SIMATIC S5/505 Automation Systems</i>	ST 50	
Components for Totally Integrated Automation and Micro Automation	ST 70	
SIMATIC PCS 7 Process Control System	ST PCS 7	
<i>PDF: Add-ons for the SIMATIC PCS 7 Process Control System</i>	ST PCS 7.A	
SIMATIC Control Systems	ST DA	
<b>SIPOS Electric Actuators</b>		
Electric Rotary, Linear and Part-turn Actuators	MP 35	
Electric Rotary Actuators for Nuclear Plants	MP 35.1/2	
<b>Systems Engineering</b>		
Power supplies SITOP power	KT 10.1	
System cabling SIMATIC TOP connect	KT 10.2	
Industrial Microcomputers SICOMP	KT 51	
<b>System Solutions</b>		
Applications and Products for Industry are part of the interactive catalog CA 01		
<b>TELEPERM M Process Control System</b>		
AS 235, AS 235H and AS 235K automation systems	PLT 111	
<i>PDF: AS 488/TM automation systems</i>	PLT 112	
Operating and monitoring with WinCC/TM	PLT 123	
CS 275 bus system	PLT 130	



The information provided in this catalog contains descriptions or characteristics of performance which in case of actual use do not always apply as described or which may change as a result of further development of the products. An obligation to provide the respective characteristics shall only exist if expressly agreed in the terms of contract. Availability and technical specifications are subject to change without notice.

Token fee: € 5,-/\$ 5,-



**Siemens AG**

Automation and Drives  
Motion Control Systems

[www.siemens.com](http://www.siemens.com)

Order no.: E86060-K5465-A301-A2-7600

**SIEMENS**

Motion Control • Servo Motors

Catalog DA 65.3 • 2004